

A modern, two-story house at night, illuminated from within. The house features large glass windows and doors. The interior is lit with warm white lights, and the living area is highlighted with blue ambient lighting. A swimming pool is visible in the foreground, reflecting the house's lights. The sky is dark blue.

tecnolite[®]

LA LUZ ES TUYA

CATÁLOGO 2021



CONTENIDO

CATÁLOGO 2021

tecnolite[®]
LA LUZ ES TUYA

- 3 **CÓMO LEER EL CATÁLOGO**
- 4 **TABLA DE EQUIVALENCIAS**
- 5 **ÍNDICE POR CÓDIGO**
- 9 **ÍNDICE POR NOMBRE**
- 13 **TECNOLITE CONNECT**
- 18 Kits
- 21 Dispositivos
- 25 Iluminación
- 33 **BOCINA INTEGRADA**
- 35 **TECNOLITE LINTERNAS**
- 39 **TECNOLITE EMERGENCIA**
- 42 **LED SÚPER AHORRADOR**
- 43 **INTERIOR**

45 **ACENTO**

- 47 Empotrados LED Ocultos
- 49 Empotrados Ocultos
- 51 Empotrados LED
- 61 Empotrados
- 72 Sobreponer
- 72 A prueba de vapor empotrados
- 73 Luz de Cortesía LED
- 75 Spot Riel LED
- 77 Spot Riel
- 77 Spot Riel Accesorios
- 79 Spot Sobreponer LED
- 83 Spot Sobreponer

91 **DECORATIVA**

- 93 Suspendidos LED
- 96 Suspendidos
- 131 Plafones LED Gran Formato
- 132 Plafones LED
- 139 Plafones LED Especialidad
- 142 Plafones
- 146 Lectura LED
- 148 Lectura
- 149 Pared LED
- 155 Pared

165 **COMERCIAL**

- 167 Lineales LED
- 174 A Prueba de Vapor LED
- 176 A Prueba de Vapor

177 **OFICINA**

- 179 Empotrados LED
- 185 Sobreponer LED
- 186 Suspendidos LED

191 **INDUSTRIAL**

- 193 Suspendidos LED

197 **EXTERIOR**

199 **DECORATIVA**

- 201 Solares
- 202 Muros LED
- 221 Muros
- 232 Suspendidos
- 234 Mini Postes LED
- 239 Mini Postes
- 241 Postes LED
- 242 Postes

243 **ACENTO**

- 245 Reflectores LED
- 253 Reflectores
- 254 Sumergibles LED
- 255 Sumergibles
- 256 Empotrados Piso LED
- 260 Empotrados Piso
- 262 Luz de Cortesía LED
- 268 Luz de Cortesía

269 **SUB-URBANO / INDUSTRIAL**

- 271 Punta de Poste
- 272 Muro
- 273 Solar
- 274 Muro Fluo

275 **LÁMPARAS**

277 **CCT**

- 277 MR11 - MR16
- 279 GU10
- 280 Ampolletas
- 282 AR111 - GX5.3
- 283 Filamento
- 285 Miniatura
- 286 Vela
- 287 Globo
- 287 JDR
- 288 A19
- 290 Circular
- 291 Flama / Bend / 360°
- 293 Pares
- 296 Alta Potencia
- 300 Tubos

304 **COLOR**

- 305 Moon Light
- 307 MR16
- 308 Miniatura
- 309 JDR
- 310 A19
- 310 Pares

311 **VINTAGE**

- 312 LED
- 319 Incandescente

321 **SOCKETS**

324 **FLUORESCENTES**

326 **ÍNDICE DE PROTECCIÓN (IP)**

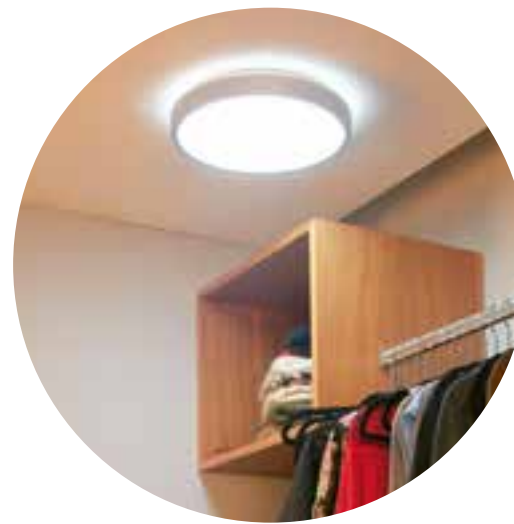

Fotografía del producto

Diagrama

Sección

Familia

Subfamilia

EXTERIOR / DECORATIVA / SOLARES

196 — Número de página

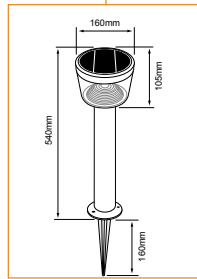

PANEL SOLAR

Nombre
Código del producto

KOI I
1SOLLED10VD30S

LUZ SUAVE CÁLIDA
● 3 000 K

Lúmenes: **120 lm**
Potencia: 1 W
Volts: 3.7 Vcc

Terminado: **Satinado**
IRC: **80**
Vida útil: **30 000 h**
Ángulo: **180 °**
IP: **44**
Tipo de lámpara: **LED (Integrado)**
Atenuable: **No**
Duración de batería recargable hasta 5 horas
Incluye estaca

Característica diferencial



PANEL SOLAR

KOI II
1SOLLED11VD30S

LUZ SUAVE CÁLIDA
● 3 000 K

Lúmenes: **120 lm**
Potencia: 1 W
Volts: 3.7 Vcc

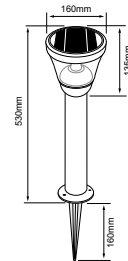

Terminado: **Satinado**
IRC: **80**
Vida útil: **30 000 h**
Ángulo: **180 °**
IP: **44**
Tipo de lámpara: **LED (Integrado)**
Atenuable: **No**
Duración de batería recargable hasta 5 horas
Incluye estaca

FICHA TÉCNICA
(Especificaciones del producto)



Imagen producto aplicado
(Sugerencia)

*Tecnolite se reserva el derecho de modificar la información sin previo aviso y no se hace responsable por errores u omisiones en este documento.

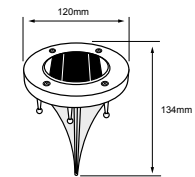

PANEL SOLAR

NUEVO
CAPH
0SOLLED12VD30S

LUZ SUAVE CÁLIDA
● 3 000 K

Lúmenes: **10 lm**
Potencia: 0.08 W
Volts: 1.2 Vcc

Terminado: **Satin**
IRC: **80**
Vida útil: **15 000 h**
IP: **65**
Tipo de lámpara: **LED (Integrado)**
Atenuable: **No**
Duración de batería recargable hasta 7 horas
Incluye estaca

Identificador de Tecnología LED



Identificador de producto **NUEVO**

ADIÓS WATTS, HOLA LUMENS

LUMEN=INTENSIDAD DE LA LUZ

WATTS=CONSUMO DE ENERGÍA

TABLA DE EQUIVALENCIA LED VS ILUMINACIÓN TRADICIONAL

LUMEN CANTIDAD DE LUZ QUE EMITEN	LED	FLUORESCENTE	TUBO FLUORESCENTE	INCANDESCENTES Y HALÓGENOS
80-120	2 W	6 W		20 W
120-250	3 W	8 W		35 W
280-380	5 W	11 W		40 W
360-500	6 W	13 W	12 W	50 W
500-700	7 W	15 W	14 W	60 W
700-850	9 W	18 W	18 W	70 W
800-900	10 W	20 W	20 W	80 W
850-1000	12 W	25 W	25 W	100 W
950-1200	13 W	30 W	28 W	110 W
1150-1350	15 W	40 W	32 W	130 W
1300-1500	18 W	50 W	36 W	140 W
1600-1800	20 W	60 W	44 W	150 W
1850-2050	25 W	70 W	58 W	200 W
2200-2650	30 W	80 W	70 W	250 W
3000-4000	50 W	100 W	120 W	400 W
6000-7500	80 W	150 W		600 W
9000-10000	100 W	200 W		750 W
10500-12000	120 W	250 W		850 W
13000-15000	150 W	300 W		1000 W
18000-20000	200 W	400 W		1500 W

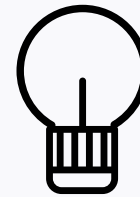

LEDS

TEMPO DE VIDA
LARGA DURACIÓN

AHORRO DE ENERGÍA
75 - 90%
EN CONSUMO DE ENERGÍA ELÉCTRICA

EFICACIA LUMÍNICA, SOLO
90%
DE LA ENERGÍA QUE CONSUMES
SE TRANSFORMA EN LUZ

COLOR DE LUZ
● BLANCO SUAVE
○ BLANCO NEUTRO
● BLANCO INTENSO
● RGB
○ ATENUABLE

Duración equivalente a 20 lámparas comunes

FLUORESCENTES

TEMPO DE VIDA
2 AÑOS

AHORRO DE ENERGÍA
60%
EN CONSUMO DE ENERGÍA ELÉCTRICA

EFICACIA LUMÍNICA, SOLO
60%
DE LA ENERGÍA QUE CONSUMES
SE TRANSFORMA EN LUZ

COLOR DE LUZ
● BLANCO CÁLIDO
○ BLANCO FRÍO
● LUZ DE DÍA

Duración equivalente a 8 lámparas comunes

INCANDESCENTES

TEMPO DE VIDA
1 AÑO

AHORRO DE ENERGÍA
0%
EN CONSUMO DE ENERGÍA ELÉCTRICA

EFICACIA LUMÍNICA, SOLO
15%
DE LA ENERGÍA QUE CONSUMES
SE TRANSFORMA EN LUZ

COLOR DE LUZ
● BLANCO CÁLIDO
○ ATENUABLE

¡¡¡ GENERA RAYOS UV NOCIVOS PARA LA SALUD !!!
EMITE CALOR

⚠ Genera calor y consume un alto nivel de energía eléctrica, el cual provoca mayor empleo en combustibles fósiles, daños al medio ambiente y calentamiento del mismo.

*Estos valores son aproximados.



A close-up photograph of a modern outdoor lighting fixture. The fixture has a black, cylindrical, tapered top section and a bright orange, conical bottom section. It is mounted on a black metal pole. The background is a lush green lawn with some blurred foliage in the upper right corner.

ÍNDICE

POR CÓDIGO

tecnolite®
LA LUZ ES TUYA



ÍNDICE

POR NOMBRE

tecnolite®
LA LUZ ES TUYA

NOMBRE	PÁG.	NOMBRE	PÁG.	NOMBRE	PÁG.	NOMBRE	PÁG.	NOMBRE	PÁG.	NOMBRE	PÁG.		
AACHEN II	211	AL MANAMA	211	ALNITA I	79	ANSHAN I	265	AUVA	123	BELLAGIO	84	BREME I	84
AACHEN III	211	AL MANAMA I	211	ALNITA II	79	ANSHAN I	265	AUVA II	122	BELLAGIO	84	BREME I	84
ABEBA	51	ALADFAR I	250	ALNIYA I	80	ANSHAN II	265	AUVA III	123	BELLAGIO	84	BRENO	86
ABEBA	51	ALADFAR II	250	ALNIYA I	80	ANSHAN II	265	AUVA III	123	BELLAGIO I	77	BRIGHTON IX	56
ABERDEEN	201	ALASIA I	64	ALNIYA II	80	ANSHAN III	265	AVIOR	264	BELLAGIO I	77	BRIGHTON IX	56
ABIYÁN	212	ALASIA II	64	ALNIYA II	80	ANSHAN III	265	AVIOR	264	BELLAGIO I	77	BRIGHTON VI	56
ABOU	201	ALATRI	65	ALORA	238	ANSHAN IV	266	AVOIR	77	BELLIZI	78	BRIGHTON VI	56
ABSOLUNO I	64	ALBA	65	ALORA I	238	ANSHAN V	266	AVOIR	77	BELLIZI	78	BRIGHTON VII	56
ABSOLUNO II	64	ALBA	65	ALORA I	238	ANTARES I	254	AVOIR I	83	BELLIZI	78	BRIGHTON VII	56
ACAMAR	47	ALBALI II	131	ALPHA I	290	ANTARES II	254	AVOIR I	83	BELLIZI	78	BRIGHTON VIII	56
ACAMAR	131	ALBIREO I	316	ALPINO	239	ANTEQUERA	240	AWARE	21	BENDIN	245	BRIGHTON VIII	56
ACAMAR II	47	ALBIREO II	316	ALRAKIS	150	ANTEQUERA	240	AZHA I	94	BENETNASCH	116	BRUSELAS	88
ACAMAR III	47	ALCOR	52	ALRESCHA	150	ANTEQUERA I	240	AZHA II	94	BERENICES II	155	BRUSELAS I	88
ACANTHUS	211	ALCOR	52	ALRUBA	150	ANTLIA	208	AZMIDI II	181	BERENICES III	155	BUCARAMANGA IX	55
ACARI	67	ALCOR	52	ALSHAIN	64	ANTONELLA	227	AZMIDI II	181	BERENICES IV	100	BUCARAMANGA IX	55
ACARI	67	ALCOR	52	ALTAIR I	54	ANYAMA	259	BACCOLI	65	BERENICES V	100	BUCARAMANGA VI	55
ACARI	67	ALEZIO	69	ALTAIR II	54	ANZIO	66	BACCOLI	65	BESSEL	116	BUCARAMANGA VI	55
ACARI	67	ALEZIO	69	ALTAIS	159	APODIS	104	BACO	253	BETULA	214	BUCARAMANGA VI	55
ACARI	67	ALEZIO	69	ALTAMIRA	239	APRICA	67	BACO I	253	BHARANI	263	BUCARAMANGA VII	55
ACARI I	65	ALEZIO	69	ALUDRA	93	APRICA	67	BADALONA	242	BIHAM V	196	BUCARAMANGA VII	55
ACARI I	65	ALEZIO	69	ALULA	62	APUS	217	BADALONA	242	BIHAM V	298	BUCARAMANGA VII	55
ACCESORIO	181	ALEZIO	69	ALULA	62	AQUARIUS	225	BADESI	70	BILAR	253	BUCARAMANGA VII SMART	27
ACERRA	67	ALFA	54	ALYA	108	AQUARIUS	225	BALEN	86	BILAR I	253	BUCARAMANGA VII SMART	27
ACERRA	67	ALGEDI I	137	ALYAD	188	AQUILA	295	BALEN I	86	BILBAO	253	BUCARAMANGA VIII	55
ACERRA	67	ALGEDI I	137	AMADIO	72	AQUILA	295	BALLABIA	70	BILBAO I	253	BUCARAMANGA VIII	55
ACHERNAR I	132	ALGEDI II	137	AMELIA	66	ARA	225	BALME I	70	BILBAO III	253	BUCARAMANGA VIII	55
ACRAB	318	ALGEDI II	137	AMPUS	168	ARBOREA	214	BAMBA	114	BILBAO IV	253	BUNDA	148
ACRAB	318	ALGEDI III	137	AMPUS	168	ARCO	63	BAMBA I	114	BILBAU I	246	BURSERA	245
ACRUX	182	ALGEDI III	137	AMPUS SMART	29	ARCO I	63	BAMBA II	114	BILBAU II	246	CAELUM	82
ACRUX	182	ALGEDI IV	137	AMSTERDAM	239	ARCTURUS	245	BAMBERA	127	BITELLO	84	CAELUM	82
ACUBENS	318	ALGEDI IV	137	ANDORA	68	ARESE	63	BAMBERA	127	BIXA	225	CAELUM	82
ACUBENS	318	ALGOL	310	ANDORA	68	ARIETTIS	104	BAMIRO	126	BIXA	225	CALGARY	258
ADANA	259	ALGOL	310	ANDORA	68	ARTEMISA	108	BAMIRA	126	BOLOGNIA	88	CALICUT	258
ADELAIDE	51	ALGOL	310	ANDORA	68	ASELLUS I	76	BARATI	259	BOLOGNIA I	88	CALICUT I	258
ADELAIDE	51	ALGOL	310	ANDORA	68	ASELLUS I	76	BARCELO	87	BOLOGNIA II	88	CAMENARO	89
ADHAFERA	317	ALHENA	54	ANDORA	68	ASELLUS II	81	BARCELO I	87	BOREALIS	293	CAMENARO I	89
ADHAFERA	317	ALICANTE	61	ANDORA	68	ASHLESHA	79	BARI	65	BOREALIS	293	CAMENARO I	89
ADHARA I	216	ALICANTE	61	ANDORA	68	ASHLESHA	79	BARI	65	BOREALIS I	294	CAMPI	89
ADHARA II	234	ALICANTE	61	ANDORA	68	ASHLESHA I	79	BASTIA	119	BOREALIS I	294	CANCRI	149
ADHIL	41	ALICANTE I	61	ANDORRA	215	ASHLESHA I	79	BASTIA I	119	BOREALIS II	295	CANCRI SMART	28
ADRIA I	72	ALICANTE I	61	ANDROMEDA	208	ASTEROPE	79	BAVENO	84	BOREALIS II	295	CANES	49
ADRIA I	72	ALICANTE I	61	ANGUSTA	70	ASTEROPE	79	BAVENO	84	BOSCA	90	CANIS	93
ADRIA II	72	ALICANTE II	61	ANIL II	73	ASTEROPE I	79	BEAM SMART	26	BOSCA I	90	CANOPUS	258
ADRIA II	72	ALICANTE II	61	ANKAA I	138	ASTEROPE I	79	BEAUVAIS	54	BOSCA I	90	CAPELA	282
AFFI	71	ALICANTE II	61	ANKAA I	138	ASTI	67	BEAUVAIS	54	BOSCA II	90	CAPELA	282
AFFI	71	ALIOTH I	59	ANKAA II	138	ASTI	67	BEID I	76	BOSCAR III	90	CAPELA I	167
AFRODITA	111	ALIOTH I	59	ANKAA II	138	ATENEA	107	BEID I	76	BOTEIN	148	CAPELA I	167
AGORA	122	ALIOTH II	59	ANKAA III	138	ATIK I	55	BEID II	81	BOX	314	CAPELLA	168
AGORA II	122	ALIOTH II	59	ANKAA III	138	ATIK II	55	BEID II	81	BOYERO	76	CAPELLA	168
AGORA III	123	ALIOTH III	59	ANKAA IV	138	ATIK II SMART	27	BEJAR	87	BOYERO	76	CAPELLA III	167
AGRA	66	ALIOTH III	59	ANKAA IV	138	ATIK III	55	BEJAR I	87	BOYERO	76	CAPELLA III	167
AGRA	66	ALIOTH III	59	ANKARA	239	ATIK III SMART	27	BEJAR II	87	BRACHIUM I	85	CAPELLA SMART	29
AHIL	314	ALKES	296	ANSER	134	ATIK IV	55	BELFORT	78	BRACHIUM II	85	CAPH	201
AHIL	314	ALLEGRA	229	ANSER I	134	AUCKLAND	259	BELFORT	78	BRACHIUM III	85	CARIATI	86
AHIL	314	ALMACH	48	ANSER I	134	AURIGA	225	BELFORT	78	BRASSA	86	CASPE I	267
AHMEDABAD	50	ALMODOVAR	240	ANSER II	134	AURIGA	225	BELFORT	78	BREME	78	CASPE I	267
AHMEDABAD I	50	ALMODOVAR	240	ANSER II	134	AUSTRAL	136	BELFORT	78	BREME	78	CASSANO	89
AIN	314	ALNASI I	83	ANSER III	134	AUSTRAL	136	BELFORT I I	84	BREME	78	CASSANO I	89
AIN	314	ALNASI I	83	ANSER III	134	AUSTRALIS	207	BELFORT I I	84	BREME	78	CASTEL	89
AKABA	51	ALNIL I	73	ANSHAN	266	AUSTRALIS	207	BELFORT I I	84	BREME I	84	CASTEL	89
AKABA	51	ALNITA I	79	ANSHAN	266	AUVA	123	BELLA I	146	BREME I	84	CASTELO I	267

NOMBRE	PÁG.	NOMBRE	PÁG.	NOMBRE	PÁG.	NOMBRE	PÁG.	NOMBRE	PÁG.	NOMBRE	PÁG.	NOMBRE	PÁG.
CASTELO I	267	CRUX II	208	ENIF	69	FURUD	207	IBIZA I	133	KIT ILUMINACIÓN SMART CCT	20	LUCIDA IV	53
CASTILLO	268	CUENCA	261	ENIF I	69	FUYU	149	IBIZA II	133	KIT ILUMINACIÓN SMART RGB	20	LUCIDA IV	53
CASTULA I	97	CUENCA I	261	EPSILON	94	FUYUE	36	IBIZA II	133	KIT MONITOREO BÁSICO	19	LUCIDA IV SMART	26
CASTULA II	97	CUENCA III	261	EPSILON	94	GALLIUM	284	INDOOR SMART STRIP	25	KIT MONITOREO PLUS	19	LUCIDA IV SMART	26
CASTULA III	155	CUENCA IV	257	EPSILON II	94	GALLIUM I	284	INDUS	75	KITAL I	110	LUINI	129
C-DOMUS I	133	CUENCA V	257	EPSILON SMART	28	GALLIUM II	284	INDUS	75	KITAL II	109	LUMIA I	288
C-DOMUS II	133	CURSA	93	EPSILON SMART	28	GALLIUM III	284	INDUS I	75	KITAL III	109	LUMIA I	288
C-DOMUS III	133	CYNARA	74	EQUULEUS	235	GAMBERI	142	INDUS I	75	KOEIA I	110	LUMIERE I	247
CEDELA	257	CYNARA	74	ERIDAN I	281	GENOVA	164	INDUS II	271	KOEIA II	109	LUMIERE I	247
CELAENO I	96	CYNARA II	74	ERIDANI II	280	GENOVA	164	INDUS III	271	KOEIA III	110	LUMIERE II	247
CELAENO II	96	CYNARO II	74	ERIDANI II	280	GENZANO	164	INOMOST	144	KOI I	201	LUMIERE II	247
CEPHEI	287	CYPERUS I	248	ERIDANI III	281	GIARRE	160	INTERCRUS	272	KOKAB	273	LUMIERE III	247
CEPHEI	287	CYPERUS I	248	EROS	105	GIARRE	160	IOTA	51	KORNE	112	LUMIERE III	247
CERDEÑA	267	CYPERUS II	248	ESCALONA	255	GIBRALTAR	164	IOTA	51	KRAZ	245	LUMIERE IV	247
CERDEÑA I	267	CYPERUS II	248	ESFERIS	264	GIEDI	232	IRIDIUM	281	KYBOX	214	LUMIERE IV	247
CERES	259	CYPERUS III	248	ESFERIS	264	GINEBRA	161	IRIDIUM II	281	LA CANEE	112	LUMUS	220
CERVANTES II	48	CYPERUS III	248	ESPEJO II	274	GIRONA	161	IRIDIUM III	281	LACERTA	140	LUSITANIA	205
CERVANTES III	48	CYPERUS IV	248	ESTOCOLMO I	272	GLIESE III	196	IRIUM II	281	LACERTA	140	LUXOR	126
CERVATES I	48	CYPERUS IV	248	ETAMIN I	290	GLIESE III	298	IRLANDA	143	LACERTA I	140	LUYTEN I	62
CETI	263	CYRANO	74	ETAMIN II	290	GLOW SMART	26	ISALNDIA	144	LACERTA I	140	LUYTEN I	62
CHAIN I	36	CYRANO	74	FAIS	149	GOIANIA	158	ITURRI	144	LAOS	108	LUYTEN II	62
CHAIN II	36	DABIH I	303	FANG	203	GRESSAN	161	IUENA	143	LATINA I	142	LVIV	106
CHALAWAN I	49	DABIH I	303	FERRATA	158	GRUIS	149	IZAR I	249	LAZIO	143	LVIV I	106
CHALAWAN II	49	DABIH II	303	FEZ	161	GRUIS	149	IZAR I	249	LECCO	143	LVIV II	106
CHARA	98	DABIH II	303	FILOS	158	GRUS	207	IZAR II	251	LED 360	292	LVIV III	106
CHERTAN I	49	DANIOS II	179	FILOS I	158	HALLEY	76	IZAR III	251	LENO II	145	LYNX I	246
CHERTAN II	49	DAROCA I	260	FIRENZE	164	HALLEY	76	IZAR IV	251	LENO III	145	LYNX II	246
CHICAGO	254	DELPHINUS I	146	FLASH SMART	26	HALLEY I	75	IZAR V	251	LENO III	145	LYNX III	246
CHICAGO I	254	DELPHINUS I	146	FLAVUS	214	HALLEY I	75	JOINT	23	LEPUS	149	LYRA	34
CHIEF	23	DELPHINUS II	146	FLORENCIA	161	HALLEY I SMART	28	JUNHO	157	LERIDA	128	LYRA	34
CHORT	207	DENEB	119	FLORES	148	HALLEY I SMART	28	JUXTA I	150	LICH I	297	LYRA	34
CINTU II	203	DENIA	255	FLORES	148	HALLEY SMART	28	JUXTA II	150	LICH II	297	MAIA I	160
CIRCINUS	134	DENIA	255	FOGGIA	158	HALLEY SMART	28	JUXTA III	150	LICH III	297	MAIA II	108
CITRON	222	DIADEM II	99	FOMENO	144	HAN I	82	KAITOS	95	LICH IV	297	MAJORIS	290
CLAUDIO	204	DIADEM III	99	FONTANA	153	HAN I	82	KAITOS II	135	LICITA	220	MAJORIS	290
CLEEÍA	159	DIADEM IV	99	FORDONS I	37	HAN II	82	KALASI I	51	LIESMA	245	MAJORIS	290
CLEEÍA	159	DIADEM V	156	FORDONS II	37	HAN II	82	KALASI II	51	LIGHT GARLAND SMART	25	MALMOK I	215
CLEEÍA II	159	DIADEM VI	156	FORENTO	144	HANDEN I	36	KALASI III	51	LLII	107	MALMOK II	215
CLEEÍA II	159	DIAMOND	314	FORIO I	163	HANDEN II	36	KAMUY	57	LIMENA	127	MARE	143
COIMBRA	260	DIJON	255	FORLI	143	HEDERA	218	KAMUY	57	LITA I	54	MARE I	163
COLINA I	212	DIJON	255	FORLI I	163	HELIUM I	282	KAMUY	57	LITA I	54	MARINO	129
COLINA II	154	DOMUS I	181	FORNAX	241	HELIUM I	282	KAMUY	57	LITA II	54	MARINO I	129
COLORS SMART	26	DOMUS I	181	FORTE	163	HELIUM I	282	KAMUY	57	LITHIUM V	300	MARUK	125
COLUMBUS	141	DOMUS II	183	FORTE	163	HELIUM I	282	KAMUY	57	LITHIUM VII	302	MARUK II	125
COMA	235	DOMUS II	183	FORZA	163	HIDRUS I	288	KANG	98	LITHIUM VIII	302	MARUK III	125
CONCORDIA	164	DOMUS II SMART	30	FORZA	163	HIDRUS I	288	KAPPA	271	LOME	130	MASSA	128
CONCORDIA	164	DOMUS III	183	FOSHAN	144	HOROLOGIUM	241	KAUS I	212	LONDRA	127	MASSA	128
CONSTANZA	261	DOMUS III	183	FRANCFORT	163	HUNOR I	262	KAUS II	212	LORETO	128	MEBSUTA I	40
CONSTANZA I	261	DOMUS IV	181	FREISING	147	HUNOR I	262	KAVE I	262	LUCCA	130	MEBSUTA II	40
COPEINA	209	DOMUS IV	181	FREYRE I	153	HUNOR II	262	KAVE I	262	LUCIDA I	53	MEGREZ	196
COPEINA I	209	DOMUS IV SMART	30	FREYRE II	153	HUNOR II	262	KAVE II	262	LUCIDA I	53	MEGREZ	298
CORIDORA	211	DRACO	235	FREYRE III	153	HUNOR III	262	KAVE II	262	LUCIDA I SMART	26	MEISSA	272
CORVUS I	293	DUBHE I	190	FROMBORK	147	HUNOR III	262	KAVE III	262	LUCIDA I SMART	26	MELSI	162
CORVUS I	293	DUBHE II	190	FUJIAN	154	HYADUM	210	KAVE III	262	LUCIDA II	53	MELSI	162
CORVUS III	293	EDULUS	214	FUKU	154	HYDRA	174	KAVE IV	263	LUCIDA II	53	MELSI	162
CORVUS III	293	ELECTRA	117	FULU I	101	HYGIEA	180	KAVE IV	263	LUCIDA II SMART	26	MENEN I	185
CREATOR II	24	ELISIUM I	66	FULU II	101	HYPTIS II	296	KAVE V	263	LUCIDA II SMART	26	MENEN I	185
CREATOR III	24	ELISIUM II	66	FULU III	101	HYPTIS III	296	KAVE V	263	LUCIDA III	53	MENEN II	185
CREATOR IV	24	ENCKE	206	FULU IV	155	IBIZA	133	KEID	118	LUCIDA III	53	MENEN II	185
CREATOR IV	24	ENEKO	204	FULU V	156	IBIZA	133	KENTAURUS	121	LUCIDA III SMART	26	MERAK	109
CRUX	208	ENEKO	204	FULU VI	156	IBIZA I	133	KIT CONTROL BÁSICO	18	LUCIDA III SMART	26	MERCURI	283

NOMBRE	PÁG.	NOMBRE	PÁG.	NOMBRE	PÁG.	NOMBRE	PÁG.	NOMBRE	PÁG.	NOMBRE	PÁG.		
MERCURI I	283	NENQUE I	139	PADANG	136	RABAT	219	SALERMO	230	TESTA	38	VULPECULA	317
MERCURI II	283	NENQUE II	139	PADANG I	136	RADIUM I	277	SALERMO	230	TESTA II	38	VULPECULA	317
MERIDIANA	124	NENQUE II	139	PADANG I SMART	28	RADIUM II	278	SALERMO I	231	THUBAN	171	WASAT	187
MERIDIANA	124	NENQUE III	139	PADANG II	136	RADIUM III	279	SALERMO I	231	THUBAN II	171	WATCHER	22
MEROPE I	40	NENQUE III	139	PADANG II	136	RADON	283	SALM	102	TIAKI	206	WEZEN	205
MEROPE II	40	NINFA	60	PADANG II SMART	28	RAN I	121	SAN JUAN I	230	TIAN	118	WURREN	205
MESSINA	162	NINFA	60	PADANG SMART	28	RAN II	121	SAN REMO	231	TIAN	118	YED	280
MESSINA	162	NOVA	57	PALIKIR I	172	RAN III	157	SAN REMO	231	TIRANA	224	YILDUN	152
MIMOSA	113	NOVA	57	PALIKIR II	172	RANGÚN	219	SANTIAGO	233	TITANIUM I	289	ZAKAR	37
MINCHIR	113	NOVA	57	PEGASUS I	294	RANGÚN I	218	SARAJEVO	228	TITANIUM I	289	ZANIAH I	289
MINERVA	107	NOVA I	57	PEGASUS I	294	RASALAS	124	SARGAS	141	TITANIUM I	289	ZANIAH II	289
MISAM	115	NOVA I	57	PEGASUS III	294	RASALAS	124	SARGAS	141	TITANIUM II	289	ZETA	136
MISAM	115	NOVA SMART	27	PEGASUS III	294	RAUCH	222	SARIN	102	TITANIUM V	288	ZETA I	136
MODULARE I	54	NOVA SMART	27	PEGASUS IV	294	RAVENNE	215	SATELITE	93	TITANIUM V	288	ZIBAL I	249
MOMO	256	NUNKI	288	PEKIN V	170	RAWENNA	215	SATELITE II	132	TITAWIN	203	ZIBAL I	249
MONOCEROS	256	NUNKI	288	PEKIN VI	170	RECEPTION	22	SCENT	23	TOLEDO	221	ZIBAL II	249
MONTISI III	184	OBELIX III	237	PEKIN VII	170	REGOR I	193	SCUTUM	317	TOLEDO	221	ZIBAL II	249
MONTISI III	184	OBELIX IV	237	PEKIN VIII	170	REGOR II	193	SECUNDA I	194	TOLEDO I	221	ZIBAL III	249
MONTISI V	185	OCTANUS	277	PERSEIDA	210	REGOR III	193	SECUNDA II	194	TOLEDO I	221	ZIBAL III	249
MONTISI V	185	OGMA I	300	PERSEUS	107	REGOR III	193	SECUNDA III	194	TORCULAR I	202	ZIBAL IV	249
MONTOYA II	185	OGMA II	300	PETRA	229	REGOR III	193	SEGOVIA	229	TORCULAR II	202	ZIBAL IV	249
MONTOYA II	185	OGMA II	300	PIAUTOS II	142	REGOR III	193	SELENE	105	TORINO	212	ZIBAL V	252
MULTISMART	23	OGMA III	301	PICTORIS	75	REGOR III	193	SELENE II	105	TOULON	224	ZIBAL VI	252
MUNICH	58	OGMA IV	301	PING	81	REGOR III	193	SESTUS	111	TOULON II	209	ZIBAL VII	252
MUNICH	58	OGMA IV	301	PIPIRIMA	116	REGOR III	193	SHAM	151	TOULON III	221	ZIBAL VIII	252
MUSCIDA	115	OKAB I	139	PISCES I	280	REGOR III	193	SHERATAN	151	TRENTO	224	ZIBO	213
MUSCIDA	115	OKAB I	139	PISCES I	280	REGOR III	193	SHERATAN II	151	TREVISO	222	ZIGONG	213
MUZIE	34	OKAB II	139	PISCES II	280	REVENNA	228	SIENA	231	TREZZA	224	ZINNER	206
NADI	58	OKAB II	139	PISCES II	280	RIGEL	69	SIENA	231	TULA I	267	ZION	168
NADI	58	OKAB III	139	PLEYONE	210	RIGEL	69	SIENA	231	TUREIS	206	ZION SMART	29
NADI	58	OKAB III	139	POLARIS	117	RIGEL	69	SIENA	231	TURIN	223		
NADI	58	OKUL I	157	POLARIS I	160	RIGEL	69	SIENA II	233	TURIN	223		
NAGOYA II	186	OKUL I	157	POLIS I	236	RIGEL	69	SIENA II	233	TURIN I	223		
NAGOYA II	186	OKUL II	157	POLIS II	236	RIGEL	69	SIENA II	233	TURIN I	223		
NAMEN I	187	OLMO	58	POLLUX	80	RIGEL	69	SIRIO	227	TUTTLE	208		
NANCHONG	63	OLMO	58	POLLUX	80	RIGEL	69	SIRIUS II	137	UNUK	103		
NANCHONG I	63	OLMO	58	POLLUX II	206	RIGIL	120	SIRIUS III	138	URANIUM I	50		
NANCHONG II	63	OLMO	58	POMPEYA II	196	RIMNI	228	SIRRAH	160	URANIUM II	50		
NAOS	52	OLMO	58	PORTLAND	135	ROCCA	229	SKAT	152	URBINO	221		
NAOS	52	OLMO	58	PORTLAND I	135	ROMA	230	SMART ALARM	21	URBINO	221		
NAOS	52	OPEN ALERT	21	PORTOFINO	173	ROMA II	232	SMART COLOR BEAMS	25	URBINO II	209		
NAOS I	52	OPHIUCHI I	203	PORTOFINO II	173	RONDA	229	SOLARIUM	66	URBINO II	209		
NAOS I	52	OPHIUCHI II	203	PORVOO	154	RONDA I	233	SPECTRUM	203	URSA	142		
NAOS I	52	OPORTO II	175	POTENCA I	195	RUBIDEA I	169	SPECTRUM	203	URSA II	122		
NAOS I SMART	27	OPORTO II	175	POTENCA II	195	RUBIDEA II	169	SPECTRUM II	209	VALETA	220		
NAOS II	52	OPORTO III	174	POTENCA III	195	RUBIDEA III	169	SPICA	227	VEGA II	227		
NAOS II	52	OPORTO III	174	POZNA	228	RUBIDEA IV	169	SPICA II	239	VELORUM	95		
NAOS II	52	OPORTO IV	174	PRAIA	81	RUSO	228	SUALOCIN	152	VENATICI	204		
NARBONA	71	OPORTO IV	174	PRAIA	81	RUTA	256	SUPERBA I	264	VENECIA	222		
NARBONA	71	OPORTO V	176	PRAVIA	212	SABIK	132	SUPERBA II	264	VENUS	111		
NASHIRA II	135	OPORTO VI	176	PRIMA	120	SABIK	132	TAIGETE	210	VERITATE I	202		
NASHIRA II	135	ORBIX	256	PRINCEPS	104	SABINO	230	TAIGETE II	216	VERITATE II	202		
NASHIRA III	135	OREMBURGO IV	184	PROCION	103	SACLATENI	132	TALIN	224	VICENZA II	220		
NASHIRA III	135	OREMBURGO IV	184	PROCION	103	SACLATENI	132	TARAZED	186	VIEWER	22		
NASHVILLE	189	OREMBURGO V	184	PROCYON	210	SADACHBIA	132	TARENTO	217	VIGIA	41		
NASHVILLE I	189	OREMBURGO V	184	PROPUS	103	SADACHBIA	132	TARF	180	VINDEMIATRIX	205		
NEIVA	189	ORION VI	295	PROPUS	103	SADIRA	227	TARF	180	VITORIO II	220		
NEIVA	189	ORION VI	295	PYXIES III	278	SADIRA	227	TAULA	37	VOLANS I	58		
NEIVA II	190	OUTDOOR SMART STRIP	25	PYXIES III	278	SAFE LOCK	21	TENERIFE	217	VOLANS I	58		
NEIVA III	190	OXALIS	218	PYXIES IV	279	SAIPH	102	TERME	229	VOLANS I	58		
NENQUE I	139	PADANG	136	PYXIES IV	279	SALERMO	230	TERME I	232	VOLANS I	58		
						SALERMO	230						



tecnolite[®] CONNECT

WOW YOUR LIFE![®]

HOGAR DULCE HOGAR INTELIGENTE

Imagina comenzar el día con tu alarma, una voz anunciando el pronóstico del día, la luz de tu habitación encendiéndose poco a poco y después la cafetera preparando el primer café del día.



TODO ESTO SIN MOVER UN DEDO

Wow Your Life! con Tecnolife Connect

EMPIEZA A VIVIR LA EXPERIENCIA

WOW!



tecnolite[®]

CONNECT

CERCA DE CASA
SIN IMPORTAR
DONDE ESTÉS

Conéctate y controla
desde tu smartphone,
y vive extraordinario
lo ordinario.

Tecnolite Connect es una línea de productos inteligentes controlados por una aplicación fácil y sencilla, para que puedas monitorear lo que pasa en tu hogar o negocio dentro o fuera del mismo.

Compatible con más de 50 mil productos en el mercado, la APP de Tecnolite Connect controla, crea escenas y automatiza tus espacios para vivir con mayor seguridad y comodidad.



¿Sabes quién es Tecnolite Connect?



CUANDO QUIERAS. DESDE DONDE SEA

Tecnolite Connect tiene para ti una gama de productos que te brindará la mejor experiencia de un hogar inteligente. Toma el control y deja que tus dispositivos hagan lo que tu quieras y más.



CONTROL APP

Controla el sistema desde una aplicación gratuita y muy fácil de usar, que se descarga en tu teléfono celular o tableta (disponible en Apple Store y Play Store) en tu idioma.



DESCARGA LA APP



CREA ESCENAS

Crea momentos perfectos con tus dispositivos para que interactúen como tu quieras y hacer tu vida increíble; como una escena de "Buenos días" que encenderá tus luces poco a poco al sonar tu despertador.



TECNOLOGÍA WIRELESS WIFI

- No necesita cables, ni ninguna instalación especial.
- Instálalo en 30 segundos.



CONTROL POR VOZ

Una vez configurado el sistema puedes controlar lo que ocurre en tu hogar o negocio, sólo pídelo. Activa, arma, enciende, apaga, atenúa con un simple comando de voz a través de Alexa o Google Home.



Compatible con: Google Assistant amazon alexa

Amazon, Alexa y Alexa logo son marcas registradas de Amazon.com, Inc. o sus filiales. Google y Home son marcas registradas de Google LLC. App Store es una marca de propiedad de Apple Inc.

EL CONTROL DE LO QUE PASA EN CASA, EN MI MANOS

Configura las acciones de tus dispositivos, goza de combinaciones infinitas y conecta tu vida.



Conoce los beneficios de la APP



TOMA TODO EL CONTROL



MULTIUSUARIO (NIVELES DE PERMISO)

Cualquiera puede tener el control. No necesitas configurar el sistema de nuevo y puede ser solamente por el tiempo que tú decidas.



RECIBE NOTIFICACIONES

Tus dispositivos te avisarán, por medio de notificaciones a tu smartphone, cualquier tipo de evento, movimiento o alerta que esté ocurriendo en tu espacio.



PROGRAMACIÓN

Automatización de acuerdo a tus necesidades. ¡Sal sin preocupaciones! Activa tus dispositivos o escenas los días que tu quieras o activa las luces en horarios específicos para que parezca que tu casa está habitada mientras no estás.



MODO VACACIONES

¡Sal sin preocupaciones! Configura tus luces para que parezca que tu casa está habitada mientras no te encuentras en ella; Activa tus sensores, alarma y cámaras para proteger y monitorear todo lo que pasa dentro y fuera.



MULTIUBICACIÓN

No importa en cuántos lugares hayas instalado los dispositivos TecnoLite Connect (tu casa, la oficina, el negocio...) contrólalo todo mediante una sola aplicación y un solo perfil.



ACCESIBILIDAD REMOTA

La APP TecnoLite Connect da accesibilidad remota desde cualquier parte del mundo; así puedes prender, activar, monitorear, modificar o apagar los dispositivos en el momento que tú desees.



AHORRO DE ENERGÍA

Los dispositivos son de bajo consumo de energía por lo que las baterías durarán mucho tiempo. Las luminarias tienen tecnología LED y control de intensidad de 0 a 100%, tu consumo de electricidad será menor.



SOPORTE TÉCNICO

Nosotros te ayudamos a instalar. Llámanos 800 777 lita (5483) opción 5

CONOCE NUESTRA WEB



TECNOLITECONNECT.COM



NUEVO

KIT'S

Controla todo tu hogar y comienza a decir WOW.



Mi Smart home



KIT DE CONTROL BÁSICO

AUTOMATIZACIÓN BÁSICA PARA INTERIOR
KITDOBATCW



1 Cámara videovigilancia interior



2 Clavija inteligente



2 Focos LED inteligente RGB



tecnolite
CONNECT



KIT DE MONITOREO BÁSICO

SISTEMA DE MONITOREO Y SEGURIDAD PARA INTERIORES
KITASEGTCW



2 Cámara videovigilancia interior



1 Sensor de movimiento inteligente



1 Sensor de apertura puerta / ventana inteligente



KIT DE MONITOREO PLUS

SISTEMA DE MONITOREO Y SEGURIDAD CON ALARMA
PARA INTERIORES
KITSSEGTCW



2 Cámara videovigilancia interior



1 Sensor de movimiento inteligente



1 Sensor de apertura puerta / ventana inteligente



1 Sirena smart con control



NUEVO



20

KIT DE ILUMINACIÓN SMART CCT

LÁMPARAS A 19 TONOS DE LUZ BLANCA
KITA19CCTTCW3P



3 Focos LED Inteligente CCT



KIT DE ILUMINACIÓN SMART RGB

LÁMPARAS A 19 TONOS DE LUZ BLANCA+COLORES
KITA19RGBTCW3P



3 Focos LED Inteligente RGB



tecnolite

CONNECT

SEGURIDAD

Vive la tranquilidad de tu espacio en todo momento y desde donde estés.

Los productos de la categoría de seguridad que Tecnolite Connect ofrece son dispositivos auxiliares o de apoyo para el monitoreo o inmueble del consumidor, por lo que Tecnolite no asume responsabilidad alguna en caso de robo a casa habitación.

NUEVO

SMART ALARM SIRH1VCDTCW SIRENA CON CONTROL



TERMINADO Blanco
APLICACIÓN Sobreponer
OBSERVACIONES Incluye batería recargable (300 mAh) x 1.
Incluye control llavero con batería de Litio 3 V (CR2032) x 1
Incluye eliminador

- Modo de Alarma ajustable con sonido y destello de luz
- Alarma SOS disponible
- Detección de manipulación, batería baja y apagado del sistema
- Compatible con hasta 8 mandos a distancia
- Volumen ajustable
- Control de tiempo ajustable: activar / desactivar / modo silencio
- Control remoto con distancia de transmisión hasta 50 metros

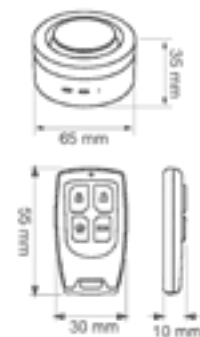

AWARE SM03WVCDBTCW SENSOR DE MOVIMIENTO



TERMINADO Blanco
APLICACIÓN Muro
OBSERVACIONES Requiere (batería 3 V 1 300 mAh CR123A Lithium x2 (no incluida))

- Sensor de Movimiento
- Notificación: Movimiento

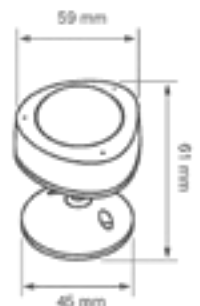

OPEN ALERT SW02WDVCDTCW SENSOR DE APERTURA PUERTA / VENTANA



TERMINADO Blanco
APLICACIÓN Ventana
OBSERVACIONES Incluye batería 1.5 V 1 100 mAh Alcalina AAA x 2

- Sensor de Apertura de puerta y/o ventana
- Notificación: Apertura puerta y/o Ventana



SAFE LOCK CIE202VCDTCW-BD BIDIRECCIONAL CERRADURA / CHAPA



TERMINADO Negro
APLICACIÓN Empotrar y sobreponer
OBSERVACIONES Aleación de Aluminio, Requiere 4 baterías AA

- 5 formas de cerrado: App / Llave / Huella digital / Código / Tarjeta de presencia
- Conexión Segura
- Apertura y cierre desde la App
- Crea códigos y Horarios de acceso
- Notificaciones: Apertura

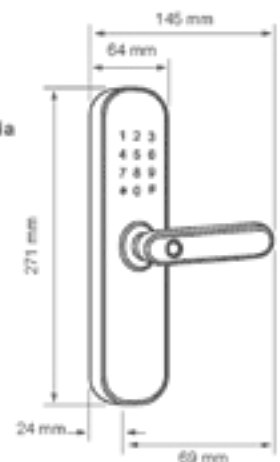

NUEVO**VIEWER****CAM6SVCDCW**

CÁMARA MONITOREO INTERIOR

**TERMINADO** Blanco y negro**APLICACIÓN** Sobreponer

*Incluye adaptador de alimentación



INTERIOR

- Video HD 1080p
- Visión nocturna
- 115° ángulo de visión
- Audio 2 vías
- Detección de movimiento
- Compatible con **MicroSD hasta 128GB** (No incluida)
- Fácil de instalar**
No necesita instalación especial

**WATCHER****CAMEXT5SVCDCW**

CÁMARA MONITOREO EXTERIOR

**TERMINADO** Blanco y Negro**APLICACIÓN** Sobreponer**OBSERVACIONES** Incluye Batería Recargable 3.6 V 6700 mAh Lithium x 2

*Incluye adaptador de alimentación y cable para carga USB



EXTERIOR



FUNCIONA CON BATERÍAS



NO NECESITA CABLES PARA INSTALACIÓN

- Video HD 1080p
- Visión nocturna
- 140° ángulo de visión
- Audio 2 vías
- Detección de movimiento
- Compatible con **MicroSD hasta 128GB** (No incluida)
- Fácil de instalar**
No necesita instalación especial

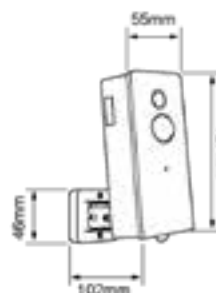
**RECEPTION****DBEXT7SVCDCW**

TIMBRE CON CÁMARA Y PARLANTE

**TERMINADO** Gris y Negro**APLICACIÓN** Muro**OBSERVACIONES** Incluye Batería Recargable 3.6 V 6700 mAh Lithium x 2

*No incluye cable para carga USB. Se recomienda comprar cable para carga USB de acuerdo a la distancia de la fuente de luz más cercana.



EXTERIOR

- Intercomunicador en tu smartphone
- Video HD 1080p
- Visión nocturna
- 140° ángulo de visión
- Audio 2 vías
- Detección de movimiento
- Compatible con **MicroSD hasta 128GB** (No incluida)
- Fácil de instalar**
No necesita instalación especial

tecnolite
CONNECT

CÁMARAS DE MONITOREO

Vigila tus espacios con video en full screen, desde donde estés.

SCENT SDIF22MVCFTCW

DIFUSOR DE AROMAS



TERMINADO Café
APLICACIÓN Sobreponer mesa
OBSERVACIONES Incluye recipiente de agua
 Incluye transformador de corriente

- Encendido y apagado remoto
- Compatible con cualquier aceite esencial
- LED de colores variables
- Fácil de instalar
No necesita instalación especial

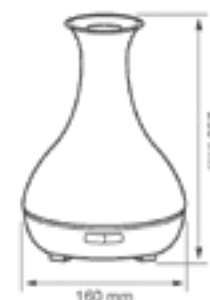

CHIEF TRI02WVCDCW

CONTROL DE INFRARROJOS



TERMINADO Negro
APLICACIÓN Sobreponer

- Control inteligente infrarrojo
- Sustituye el uso de controles remotos de equipos electrónicos con su función de aprendizaje
- Cobertura de 360° y de 7 a 10 m de distancia
- Controla tus aparatos electrónicos desde la app

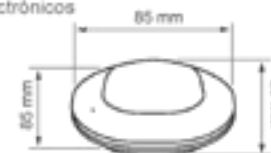

JOINT SPJ11MVBTCW

CLAVIJA INTERIOR



TERMINADO Blanco
APLICACIÓN Sobreponer
OBSERVACIONES Carga Máxima 2000 W ó 10 A

- Contacto inteligente
- Automatización del Hogar sin tener que sustituir tus aparatos eléctricos
- Encendido/Apagado remoto por APP

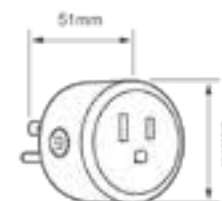

MULTISMART SMC4AC4USBMVBTCW

MULTICONTACTO



TERMINADO Blanco
APLICACIÓN Sobreponer
OBSERVACIONES Carga Máxima 2 000 W ó 10 A

- Contacto inteligente, control independiente para cada enchufe.
- Automatización del Hogar sin tener que sustituir tus aparatos eléctricos
- Encendido/Apagado remoto por APP



ENERGÍA Y CONTROL

Reinventa tus electrodomésticos, hazlos inteligentes y toma el control desde donde estés.

NUEVO**CREATOR IV****TDSWI1MVBTCW**

INTERRUPTOR DE 3 PUNTOS CON ATENUADOR



TERMINADO Blanco
APLICACIÓN Sobreponer
OBSERVACIONES Carga Máxima 2 000 W
 ó 10 A

*Requiere cable neutro

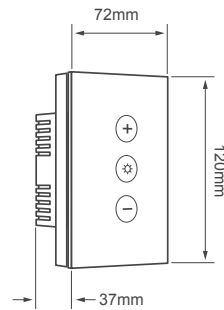
Sustituye tus **Apagadores comunes**Controla 1 circuito **eléctricos diferentes**Capacidad máxima de carga **2 000 watts**Atenua tu iluminación ***Consulta productos disponibles mil watts****Fácil de instalar**
No necesitas instalación especial**CREATOR I****TSWI1MVBTCW**

INTERRUPTOR DE 1 PUNTO



TERMINADO Blanco
APLICACIÓN Sobreponer
OBSERVACIONES Carga Máxima 2000 W
 ó 10 A

*Requiere cable neutro

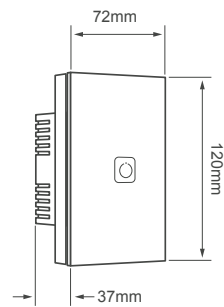
Sustituye tus **Apagadores comunes**Controla 1 circuito **eléctrico diferente**Capacidad máxima de carga **2 000 watts, 10 A****Fácil de instalar**
No necesitas instalación especial**CREATOR II****TSWI2MVBTCW**

INTERRUPTOR DE 2 PUNTOS



TERMINADO Blanco
APLICACIÓN Sobreponer
OBSERVACIONES Carga Máxima 1000 W
 ó 10 A

*Requiere cable neutro

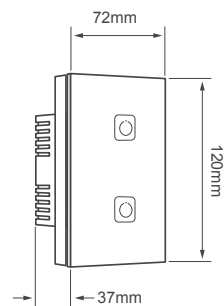
Sustituye tus **Apagadores comunes**Controla 2 circuitos **eléctricos diferentes**Capacidad máxima de carga **1 000 watts, 10 A****Fácil de instalar**
No necesitas instalación especial**CREATOR III****TSWI3MVBTCW**

INTERRUPTOR DE 3 PUNTOS



TERMINADO Blanco
APLICACIÓN Sobreponer
OBSERVACIONES Carga Máxima 700 W x 3
 ó 10 A

*Requiere cable neutro

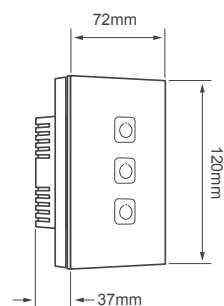
Sustituye tus **Apagadores comunes**Controla 3 circuitos **eléctricos diferentes**Capacidad máxima de carga **700 watts x 3, 10 A****Fácil de instalar**
No necesitas instalación especial

EMPIEZA A VIVIR LA EXPERIENCIA



Conoce nuestro canal











ILUMINACIÓN

Ilumina tu espacio con la amplia gama de LUMINARIOS INTELIGENTES.

BENEFICIOS DE ILUMINACIÓN CONNECT:

-  Encendido y apagado remoto
-  Control de intensidad de luz por medio de aplicación
-  64mil tonos de blancos
-  Atenuable / Dimerizable
-  Configura horarios para automatizar tu iluminación
-  Sin modificar tu instalación eléctrica
-  Conexión red inalámbrica WIFI



TIRAS LED / INTERIOR Y EXTERIOR

INDOOR SMART STRIP 15TIRLEDRGBWDCITCW TIRA LED INTERIOR



Contiene 90 LEDs
Interconexión de hasta 2 tiras
Sensor de audio (al ritmo de la música)
Atenuable/Dimerizable por medio de aplicación



*Corte de tira cada 10 cm

POTENCIA 15 W / 5 W por metro
FLUJO LUMINOSO 1 500 lm
IRC 70
VIDA ÚTIL (HORAS) 20 000 h
ÁNGULO 120 °

OBSERVACIONES Incluye eliminador, cambio de colores por aplicación o botón que se encuentra en producto

OUTDOOR SMART STRIP 15TIRLEDRGBWDCETCW TIRA LED EXTERIOR



Contiene 90 LEDs
Interconexión de hasta 2 tiras
Sensor de audio (al ritmo de la música)
Atenuable/Dimerizable por medio de aplicación

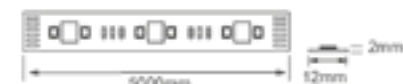

*Corte de tira cada 10 cm

POTENCIA 15 W / 5 W por metro
FLUJO LUMINOSO 1 500 lm
IRC 70
VIDA ÚTIL (HORAS) 20 000 h
ÁNGULO 120 °
IP 65

OBSERVACIONES Incluye eliminador, cambio de colores por aplicación o botón que se encuentra en producto
*El eliminador de corriente deberá estar protegido contra el agua

SERIE / EXTERIOR

LIGHT GARLAND SMART 12GRLEDRGBMVNTCW GUIRNALDA EXTERIOR



POTENCIA 12 W
IRC 80
VIDA ÚTIL (HORAS) 20 000 h
ÁNGULO 120 °
IP 44 °

OBSERVACIONES Incluye eliminador de corriente (100-240 / 12 VCD).
*El eliminador de corriente deberá estar protegido contra el agua

*Espaciado entre fuentes de luz 60cm

SMART COLOR BEAMS 12HLED59RGBMVNTCW SERIE REFLECTORES EXTERIOR

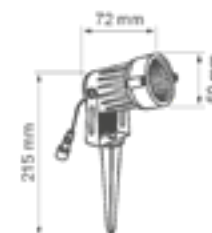

POTENCIA 12 W
IRC 80
VIDA ÚTIL (HORAS) 20 000 h
ÁNGULO 120 °
IP 65

OBSERVACIONES Incluye eliminador de corriente (100-240 / 12 VCD).
*El eliminador de corriente deberá estar protegido contra el agua

*Espaciado entre fuentes de luz 1.5m

**GLOW SMART
7A19LEDMV200TCW**



POTENCIA 7 W
TIPO DE LÁMPARA LED
FLUJO LUMINOSO 800 lm
IRC 80
VIDA ÚTIL (HORAS) 15 000 h
ÁNGULO 200 °
BASE E27
TIPO DE BULBO A
DISTRIBUCIÓN DE LUZ Omnidireccional
OBSERVACIONES Atenuable / Dimerizable por medio de la aplicación
EQUIVALENCIA A INCANDESCENTE 60 W

**COLORS SMART
8A19LEDMV200TCRGBW**



POTENCIA 8 W
TIPO DE LÁMPARA LED
FLUJO LUMINOSO 800 lm
IRC 80
VIDA ÚTIL (HORAS) 15 000 h
ÁNGULO 200 °
BASE E27
TIPO DE BULBO A
DISTRIBUCIÓN DE LUZ Omnidireccional
OBSERVACIONES Atenuable / Dimerizable por medio de la aplicación
EQUIVALENCIA A INCANDESCENTE 60 W

**BEAM SMART
5GU10LEDMV35TCW**



POTENCIA 5 W
TIPO DE LÁMPARA LED
FLUJO LUMINOSO 410 lm
IRC 80
VIDA ÚTIL (HORAS) 15 000 h
ÁNGULO 45 °
BASE GU10
TIPO DE BULBO MR
DISTRIBUCIÓN DE LUZ Direccional
OBSERVACIONES Atenuable / Dimerizable por medio de la aplicación
EQUIVALENCIA A INCANDESCENTE 40 W

**FLASH SMART
5MR16LEDMV35TCW**



POTENCIA 5 W
TIPO DE LÁMPARA LED
FLUJO LUMINOSO 410 lm
IRC 80
VIDA ÚTIL (HORAS) 15 000 h
ÁNGULO 45 °
BASE GX5.3
TIPO DE BULBO MR
DISTRIBUCIÓN DE LUZ Direccional
OBSERVACIONES Atenuable / Dimerizable por medio de la aplicación
EQUIVALENCIA A INCANDESCENTE 40 W

**LUCIDA I SMART
3YDLED3161MVBTCW**

Blanco



3YDLED3161MVNTCW

Negro

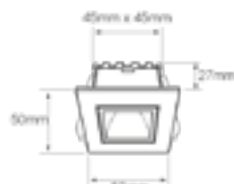

FLUJO LUMINOSO 115 lm
IRC 80
VIDA ÚTIL (HORAS) 30 000 h
ÁNGULO 34 °
OBSERVACIONES Incluye LED 3 W y DRIVER. Atenuable/Dimerizable por medio de la aplicación

**LUCIDA II SMART
6YDLED3162MVBTCW**

Blanco



3YDLED3162MVNTCW

Negro

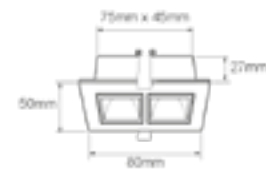

FLUJO LUMINOSO 235 lm
IRC 80
VIDA ÚTIL (HORAS) 30 000 h
ÁNGULO 34 °
OBSERVACIONES Incluye LED 6 W y DRIVER. Atenuable/Dimerizable por medio de la aplicación

**LUCIDA III SMART
7YDLED3163MVBTCW**

Blanco



7YDLED3163MVNTCW

Negro

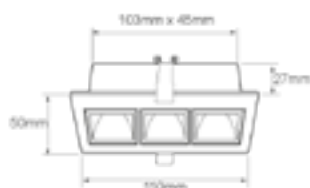

FLUJO LUMINOSO 305 lm
IRC 80
VIDA ÚTIL (HORAS) 30 000 h
ÁNGULO 34 °
OBSERVACIONES Incluye LED 7 W y DRIVER. Atenuable/Dimerizable por medio de la aplicación

**LUCIDA IV SMART
17YDLED3165MVBTCW**

Blanco



17YDLED3165MVNTCW

Negro

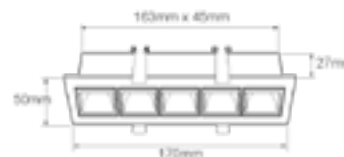

FLUJO LUMINOSO 730 lm
IRC 80
VIDA ÚTIL (HORAS) 30 000 h
ÁNGULO 34 °
OBSERVACIONES Incluye LED 17 W y DRIVER. Atenuable/Dimerizable por medio de la aplicación

*Tecnolite se reserva el derecho de modificar la información sin previo aviso y no se hace responsable por errores u omisiones en este documento.
 *Lámparas y luminarios no aptos para trabajo de voltaje constante en niveles superiores o inferiores marcados en el producto.

TECHO / EMPOTRADO
NAOS I SMART
5YDLED154MVBTCW



TERMINADO Blanco
FLUJO LUMINOSO 350 lm
IRC 80
VIDA ÚTIL (HORAS) 25 000 h
ÁNGULO 68 °
OBSERVACIONES Incluye LED 5 W y DRIVER, Atenuable/Dimerizable por medio de la aplicación

BUARAMANGA VII SMART
12YDLED430MVBTCW

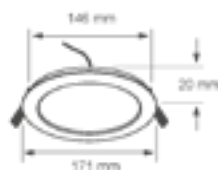

TERMINADO Blanco
FLUJO LUMINOSO 840 lm
IRC 80
VIDA ÚTIL (HORAS) 25 000 h
ÁNGULO 120 °
OBSERVACIONES Incluye LED 12 W y DRIVER, Atenuable / Dimerizable por medio de la aplicación

BUARAMANGA VIII SMART
18YDLED430MVBTCW

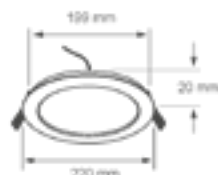

TERMINADO Blanco
FLUJO LUMINOSO 1 350 lm
IRC 80
VIDA ÚTIL (HORAS) 25 000 h
ÁNGULO 120 °
OBSERVACIONES Incluye LED 18 W y DRIVER, Atenuable / Dimerizable por medio de la aplicación

NOVA SMART
09YDLED432MVBTCW **09YDLED432MVNTCW**

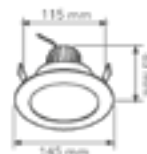

FLUJO LUMINOSO 800 lm
IRC 80
VIDA ÚTIL (HORAS) 25 000 h
ÁNGULO 100 °
OBSERVACIONES Incluye LED 9 W y DRIVER, Atenuable/Dimerizable por medio de la aplicación

ATIK II SMART
13YDLED011MVBTCW



TERMINADO Blanco
FLUJO LUMINOSO 910 lm / 1 100 lm
IRC 80
VIDA ÚTIL (HORAS) 30 000 h
ÁNGULO 90 °
OBSERVACIONES Incluye LED 13 W y DRIVER, Atenuable / Dimerizable por medio de la aplicación

ATIK III SMART
20YDLED013MVBTCW

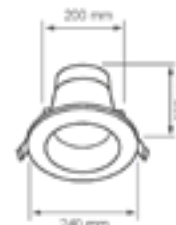

TERMINADO Blanco
FLUJO LUMINOSO 1 400 lm / 1 700 lm
IRC 80
VIDA ÚTIL (HORAS) 30 000 h
ÁNGULO 90 °
OBSERVACIONES Incluye LED 20 W y DRIVER, Atenuable / Dimerizable por medio de la aplicación



HALLEY SMART
7YSNLEDO12MVBTCW

RGB



7YSNLEDO12MVNTCW



FLUJO LUMINOSO 550 lm
IRC 80
VIDA ÚTIL (HORAS) 25 000 h
ÁNGULO 40°
OBSERVACIONES Incluye LED 7 W y DRIVER, Atenuable / Dimenzable por medio de la aplicación

HALLEY I SMART
14YSNLEDO13MVBTCW

RGB



14YSNLEDO13MVNTCW



FLUJO LUMINOSO 1 100 lm
IRC 80
VIDA ÚTIL (HORAS) 25 000 h
ÁNGULO 40°
OBSERVACIONES Incluye LED 14 W y DRIVER, Atenuable / Dimenzable por medio de la aplicación

EPSILON SMART
3CTLLED152MVBTCW

3 000 K



3CTLLED152MVNTCW

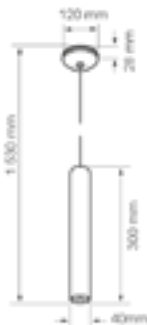

FLUJO LUMINOSO 210 lm
IRC 80
VIDA ÚTIL (HORAS) 15 000 h
ÁNGULO 10°
OBSERVACIONES Incluye LED 3 W y DRIVER, Atenuable/Dimenzable por medio de la aplicación

PADANG SMART
10PTLLED1010MVBTCW

CCT

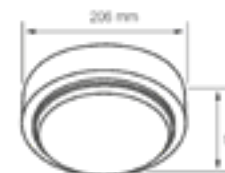

TERMINADO Blanco
FLUJO LUMINOSO 700 lm
IRC 80
VIDA ÚTIL (HORAS) 25 000 h
ÁNGULO 120°
OBSERVACIONES Incluye LED 10 W y DRIVER, Atenuable / Dimenzable por medio de la aplicación

PADANG I SMART
15PTLLED1015MVBTCW

CCT

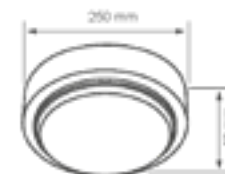

TERMINADO Blanco
FLUJO LUMINOSO 1 050 lm
IRC 80
VIDA ÚTIL (HORAS) 25 000 h
ÁNGULO 120°
OBSERVACIONES Incluye LED 15 W y DRIVER, Atenuable / Dimenzable por medio de la aplicación

PADANG II SMART
20PTLLED1020MVBTCW

CCT

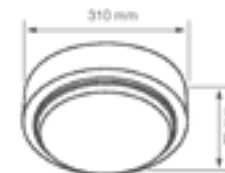

TERMINADO Blanco
FLUJO LUMINOSO 1 400 lm
IRC 80
VIDA ÚTIL (HORAS) 25 000 h
ÁNGULO 120°
OBSERVACIONES Incluye LED 20 W y DRIVER, Atenuable / Dimenzable por medio de la aplicación

CANCRI SMART
5TLLED407MVNTCW

3 000 K

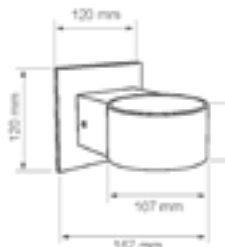

TERMINADO Negro
FLUJO LUMINOSO 315 lm
IRC 80
VIDA ÚTIL (HORAS) 25 000 h
ÁNGULO 40°
OBSERVACIONES Incluye LED 5.5 W y DRIVER, Atenuable/Dimenzable por medio de la aplicación

CAPELLA SMART 7FLCLEDO2MVBTCW

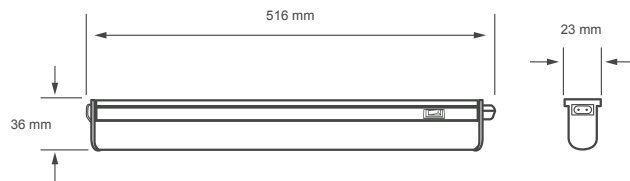

TERMINADO Blanco
FLUJO LUMINOSO 630 lm
IRC 80
VIDA ÚTIL (HORAS) 25 000 h
ÁNGULO 140 °
OBSERVACIONES Incluye LED 7 W y DRIVER, Atenuable / Dimerizable por medio de la aplicación

AMPUS SMART 14FLCLEDO3MVBTCW

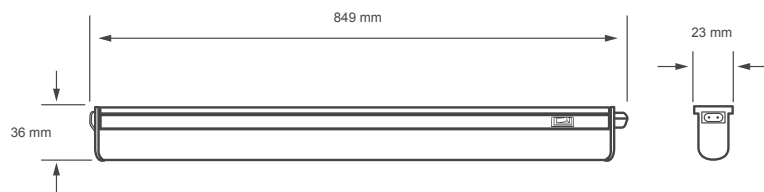

TERMINADO Blanco
FLUJO LUMINOSO 1 260 lm
IRC 80
VIDA ÚTIL (HORAS) 25 000 h
ÁNGULO 140 °
OBSERVACIONES Incluye LED 14 W y DRIVER, Atenuable / Dimerizable por medio de la aplicación

ZION SMART 35FLCPLEDO01MVBTCW

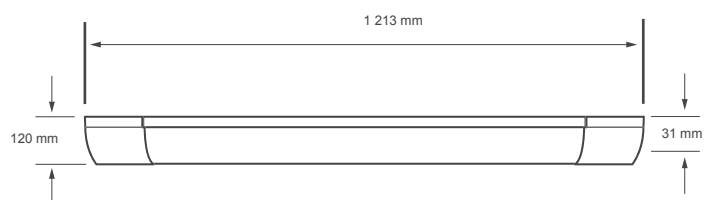

TERMINADO Blanco
FLUJO LUMINOSO 4 000 lm
IRC 80
VIDA ÚTIL (HORAS) 25 000 h
ÁNGULO 110 °
OBSERVACIONES Incluye LED 35 W y DRIVER, Atenuable / Dimerizable por medio de la aplicación



DOMUS IV SMART 40PANLEDMVBTCW

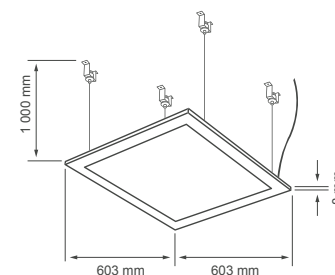

TERMINADO Blanco
FLUJO LUMINOSO 3 600 lm
IRC 80
VIDA ÚTIL (HORAS) 25 000 h
ÁNGULO 120 °
OBSERVACIONES Incluye LED 40 W y DRIVER,
 Atenuable / Dimerizable por
 medio de la aplicación

*Accesorio para suspensión A40PANLEDMVS
 se vende por separado



DOMUS II SMART 40PANLEDLVMVBTCW

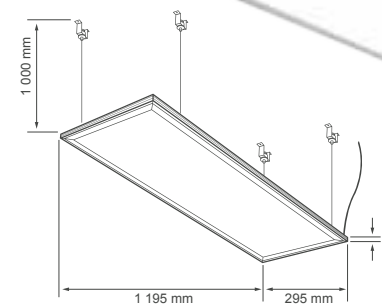
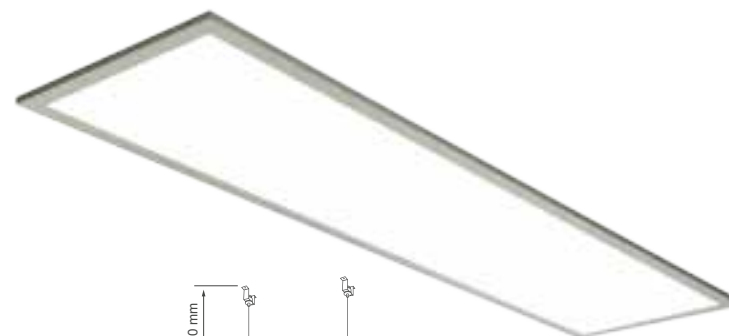

TERMINADO Blanco
FLUJO LUMINOSO 3 600 lm
IRC 80
VIDA ÚTIL (HORAS) 25 000 h
ÁNGULO 120 °
OBSERVACIONES Incluye LED 40 W y DRIVER,
 Atenuable / Dimerizable por
 medio de la aplicación

*Accesorio para suspensión A40PANLEDMVS
 se vende por separado

WOW YOUR LIFE!®



 **WOW!**
EL CONTROL EN TUS MANOS

TECNOLITECONNECT.COM    

tecnolite[®]
CONNECT



A man and a woman are dancing in a living room. The man is on the left, wearing a checkered shirt and jeans, and the woman is on the right, wearing a white sweater and dark pants. They are both smiling and looking at each other. The room has a large window in the background, a sofa, and a potted plant. The entire scene is bathed in a warm, orange light.

LUMINARIOS

BOCINA INTEGRADA

tecnolite[®]
LA LUZ ES TUYA



MUZIE

38FTLLED3LV30CF

LUZ SUAVE CÁLIDA
● 3 000 K

Lumens: **1 900 lm**
Potencia: 38 W
Volts: 127 V ~

Terminado: **Café**
IRC: 80
Vida útil: **20 000 h**
Ángulo: 119 °

IP: 54
Tipo de lámpara: **LED (Integrado)**
Atenuable: **No**
Bocina integrada
Incluye fotocelda

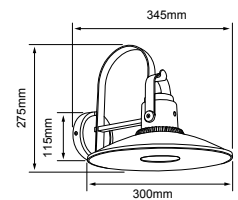

LYRA

A19SB-LED/001/30

LUZ SUAVE CÁLIDA
● 3 000 K

Lumens: **451 lm**
Volts: 100-127 V ~

Potencia: 9 W

A19SB-LED/001/40
LUZ BLANCA NEUTRA
● 4 000 K
Lumens: **451 lm**
Volts: 100-127 V ~

Terminado: **Blanco**
IRC: 80
Vida útil: **15 000 h**
Ángulo: 180 °

09A19SBLED65MV
LUZ DE DÍA
● 6 500 K
Lumens: **470 lm**
Volts: 100-240 V ~

Tipo de base: **E27**
Atenuable: **No**
Dimensiones del producto:
66 mm x 125 mm
Bocina integrada

FÁCIL DE USAR



tecnolite[®]
LA LUZ ES TUYA

LLEVA **LA LUZ**
A TODAS PARTES



CONOCE NUESTRAS

LINTERNAS

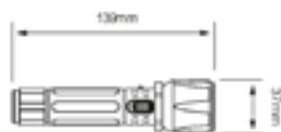

LINTERNA DE MANO
LT40140NA

POTENCIA: 1 W ENERGÍA CONSUMIDA
 FLUJO LUMINOSO: 50lm
 VIDA ÚTIL: 20 000 h
 ÁNGULO: 120°
 DURACIÓN BATERIA: 6h
 TIEMPO DE CARGA TOTAL: 10h

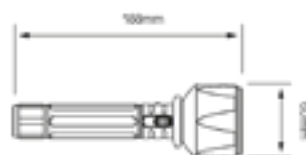
LINTERNA DE MANO
LT80190NA

POTENCIA: 1 W ENERGÍA CONSUMIDA
 FLUJO LUMINOSO: 70-90lm
 VIDA ÚTIL: 20 000 h
 ÁNGULO: 120°
 DURACIÓN BATERIA: General: 6h Puntual: 4h
 TIEMPO DE CARGA TOTAL: 10h

LINTERNA DE MANO
LT40220G

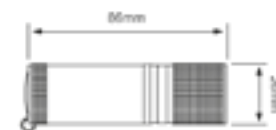

POTENCIA: 0.5 W ENERGÍA CONSUMIDA
 FLUJO LUMINOSO: 40 lm
 VIDA ÚTIL: 30 000 h

LINTERNA DE MANO
LT8086G-2C

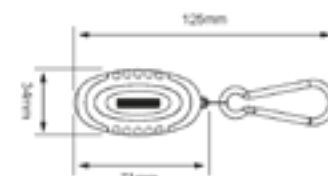
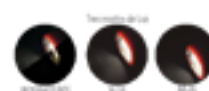
POTENCIA: 2 W ENERGÍA CONSUMIDA
 FLUJO LUMINOSO: 80 lm
 VIDA ÚTIL: 30 000 h

LINTERNA DE MANO
LT7070NA-2C

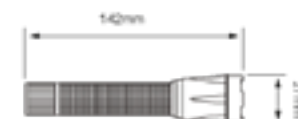
POTENCIA: 0.5 W ENERGÍA CONSUMIDA
 FLUJO LUMINOSO: 35-70 lm
 VIDA ÚTIL: 30 000 h

LINTERNA DE MANO
LT120143G

POTENCIA: 3 W ENERGÍA CONSUMIDA
 FLUJO LUMINOSO: 60-120lm
 VIDA ÚTIL: 30 000 h

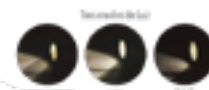
LINTERNA DE MANO
LT200170G

POTENCIA: 5 W ENERGÍA CONSUMIDA
 FLUJO LUMINOSO: 100-200 lm
 VIDA ÚTIL: 30 000 h



LINTERNA DE MANO
LT180136NA

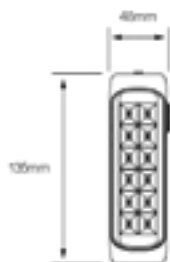

POTENCIA: 3.5 W ENERGÍA CONSUMIDA
FLUJO LUMINOSO: Baja: 90lm Alta: 180lm
VIDA ÚTIL: 20 000 h
ÁNGULO: 120°
DURACIÓN BATERIA: Baja: 6h Alta: 3h
TIEMPO DE CARGA TOTAL: 24h

LINTERNA DE MANO
LT180174NA

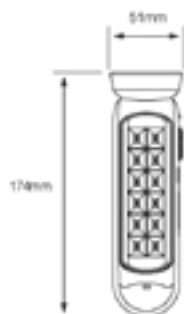

POTENCIA: 3.5 W ENERGÍA CONSUMIDA
FLUJO LUMINOSO: 100-240lm
VIDA ÚTIL: 20 000 h
ÁNGULO: 114°
DURACIÓN BATERIA: General: 2h Puntual: 4h
TIEMPO DE CARGA TOTAL: 24h

LINTERNA DE MANO
LT220228NA

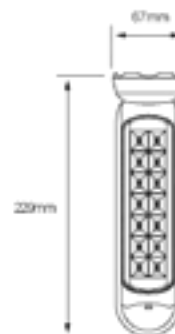

POTENCIA: 3 W ENERGÍA CONSUMIDA
FLUJO LUMINOSO: 160-360lm
VIDA ÚTIL: 20 000 h
ÁNGULO: 114°
DURACIÓN BATERIA: General: 3h Puntual: 1.5h
TIEMPO DE CARGA TOTAL: 24h

LINTERNA REFLECTOR
LT150204N

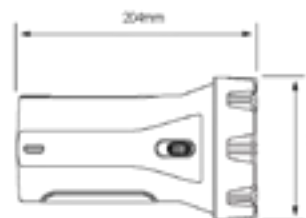

POTENCIA: 3 W ENERGÍA CONSUMIDA
FLUJO LUMINOSO: Baja: 70lm Alta: 150lm
VIDA ÚTIL: 10 000 h
ÁNGULO: 120°
DURACIÓN BATERIA: Baja: 10h Alta: 4h
TIEMPO DE CARGA TOTAL: 24h

LUZ

EN DONDE QUIERAS

LINTERNA MINERO LT12069N

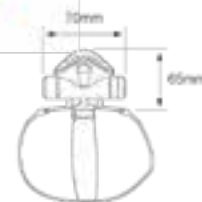

POTENCIA: 3 W ENERGÍA CONSUMIDA
FLUJO LUMINOSO: 60-120lm
VIDA ÚTIL: 30 000 h



LINTERNA MINERO LT8075N

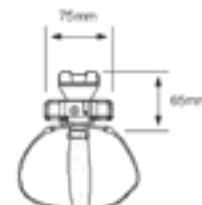

POTENCIA: 1 W ENERGÍA CONSUMIDA
FLUJO LUMINOSO: 80lm
VIDA ÚTIL: 20 000 h
ÁNGULO: 120°
DURACIÓN BATERIA: Baja: 8h Alta: 4h
TIEMPO DE CARGA TOTAL: 10h

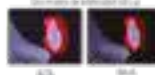



LUMINARIOS DE
EMERGENCIA

tecnolite[®]
LA LUZ ES TUYA

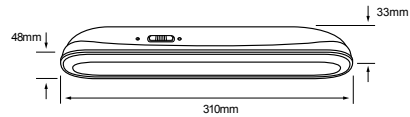

MEROPE I

5EMLED31MV65B

LUZ DE DÍA
● 6 500 K

Lumens: **140 - 280 lm**
Potencia: **0.8 W**

Terminado: Gris
Vida útil: **20 000 h**
Ángulo: **120 °**
Tipo de lámpara: LED (40 Integrados)
Duración Batería : **6 a 3 h**
Tiempo de carga total : **20-24 h**
Batería Recargable

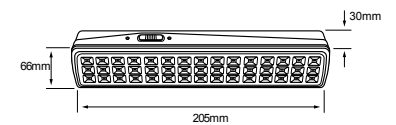

MEBSUTA I

2EMLED20MV65B

LUZ DE DÍA
● 6 500 K

Lumens: **60 - 120 lm**
Potencia: **0.5 W**

Terminado: Gris
Vida útil: **20 000 h**
Ángulo: **120 °**
Tipo de lámpara: LED (30 Integrados)
Duración Batería : **6 a 3 h**
Tiempo de carga total : **20-24 h**
Batería Recargable

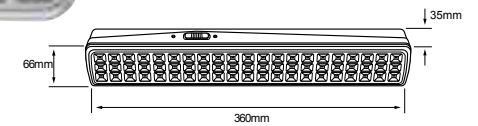

MEBSUTA II

4EMLED36MV65B

LUZ DE DÍA
● 6 500 K

Lumens: **180 - 360 lm**
Potencia: **1 W**

Terminado: Gris
Vida útil: **20 000 h**
Ángulo: **120 °**
Tipo de lámpara: LED (60 Integrados)
Duración Batería : **6 a 3 h**
Tiempo de carga total : **20-24 h**
Batería Recargable

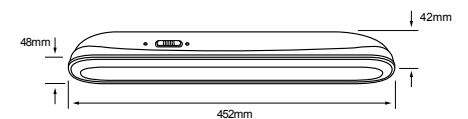

MEROPE II

7EMLED45MV65B

LUZ DE DÍA
● 6 500 K

Lumens: **180 - 360 lm**
Potencia: **1 W**

Terminado: Gris
Vida útil: **20 000 h**
Ángulo: **120 °**
Tipo de lámpara: LED (80 Integrados)
Duración Batería : **6 a 3 h**
Tiempo de carga total : **20-24 h**
Batería Recargable

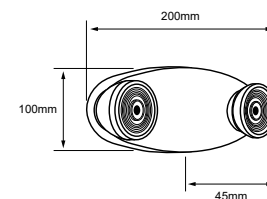

NUEVO
VIGIA
4EMLED2H20MV65B

LUZ DE DÍA
● 6 500 K

Lumens: **200 lm**
Potencia: **4 W**
Volts: **100-277 V ~**

Terminado: **Blanco**
IRC: **80**
Vida útil: **30 000 h**
Ángulo: **60°**

Tipo de lámpara: **LED (Integrado)**
Incluye: **Driver LED**
Atenuable: **No**
Duración de batería: **90min**
Tiempo de carga: **24 hrs**

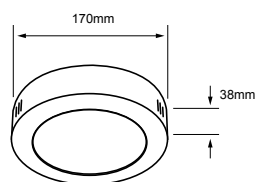

ADHIL
12EMPTLLEDR65MVB

LUZ DE DÍA
● 6 500 K

Lumens: **800 lm**
Potencia: **12 W**
Volts: **100-240 V ~**

Terminado: **Blanco**
IRC: **80**
Vida útil: **15 000 h**
Ángulo: **100°**

Tipo de lámpara: **LED (Integrado)**
Incluye: **Driver LED**
Atenuable: **No**
Duración de batería recargable: **2 hrs**
Tiempo de carga: **6-8 hrs**



09EMA19LED30MV
LUZ SUAVE CÁLIDA
● 3 000 K

Lumens: **670 lm**
Volts: **100-240 V ~**
Potencia: **9 W**
Batería **3.7 VDC**
Recargable **100-240V**

Terminado: **Blanco**
IRC: **80**
Vida útil: **25 000 h**
Ángulo: **160°**

09EMA19LED65MV
LUZ DE DÍA
● 6 500 K

Tipo de base: **E27**
Tipo de lámpara: **LED (integrado)**
Atenuable: **No**
Dimensiones del producto: **70 mm x 145 mm**
Duración de batería recargable: **2 hrs**
Tiempo de carga: **6-8 hrs**

LED SÚPER-AHORRADOR

HASTA
50% DE AHORRO
EN LUZ
vs FLUORESCENTE
*PROMEDIO



~~“AHORRADOR”~~
FLUORESCENTE

VS



MULTIVOLTAJE

LED
SÚPER-AHORRADOR

HASTA
3.5 AÑOS
DE VIDA*



HASTA
10 AÑOS
DE VIDA*

1 FLUORESCENTE
20W



=



1 LED
11W



5 AÑOS
GARANÍA
LED

*Tiempo de vida calculado con uso de 4hrs diarias en óptimas condiciones de operación. *El ahorro en el consumo de iluminación dependerá del número de watts que el consumidor sustituya.
*El ahorro general en el recibo de luz dependerá también de los diversos aparatos eléctricos usados por el consumidor.

INTERIOR

IMAGINA, ILUMINA, DECORA Y CREA
TUS MOMENTOS CON ILUMINACIÓN SIN LÍMITES

techolite®
LA LUZ ES TUYA



INTERIOR ACENTO

CREA UNA GAMA ILIMITADA DE
ESCENAS Y MOMENTOS CON DETALLES DE
ILUMINACIÓN PARA TUS ESPACIOS

tecnolite®

LA LUZ ES TUYA



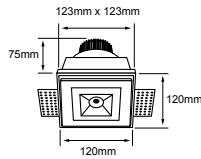

ACAMAR
5YDLED456MV30BN

LUZ SUAVE CÁLIDA
● 3 000 K

Lumens: **285 lm**
Potencia: 5.5 W
Volts: 100-240 V ~

Terminado: **Blanco**
IRC: **80**
Vida útil: **25 000 h**
Ángulo: 45°
Tipo de lámpara: LED (Integrado)

Incluye: **Driver LED**
Corte de empotramiento: **123 mm x 123 mm**
Atenuable: **No**

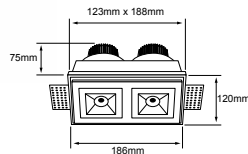

ACAMAR II
12YDLED457MV30BN

LUZ SUAVE CÁLIDA
● 3 000 K

Lumens: **513 lm**
Potencia: 12 W
Volts: 100-240 V ~

Terminado: **Blanco**
IRC: **80**
Vida útil: **25 000 h**
Ángulo: 45°

Tipo de lámpara: LED (Integrado)
Incluye: **Driver LED**
Corte de empotramiento: **188 mm x 123 mm**
Atenuable: **No**

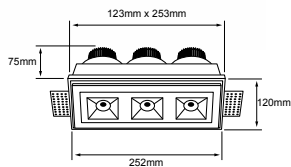

ACAMAR III
17YDLED458MV30BN
Blanco

LUZ SUAVE CÁLIDA
● 3 000 K

Lumens: **797 lm**
Potencia: 17.5 W
Volts: 100-240 V ~

Terminado: **Blanco**
IRC: **80**
Vida útil: **25 000 h**
Ángulo: 45°

Tipo de lámpara: LED (Integrado)
Incluye: **Driver LED**
Corte de empotramiento: **253 mm x 123 mm**
Atenuable: **No**

CÓMO INSTALAR LOS LUMINARIOS EMPOTRADOS LED OCULTO



-Realiza el corte en tu falso plafón y conecta el luminario



-Introduce el luminario y sujétalo con pijas



-Cubre los huecos con enjarre/revoque/mancillado y limpia la superficie



-Lija los bordes y pinta

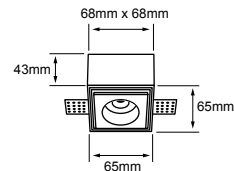

ALMACH
1YDLED464MV30B

LUZ SUAVE CÁLIDA
● 3 000 K

Lumens: 49 lm
Potencia: 1 W
Volts: 100-240 V ~

Terminado: **Blanco**
IRC: **80**
Vida útil: **25 000 h**
Ángulo: **48 °**
Incluye: **Driver LED**
Atenuable: **No**
Tipo de lámpara: **LED (integrado)**
Corte de empotramiento: **68 mm x 68 mm**

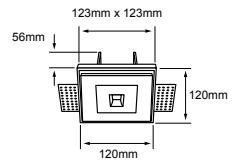

CERVANTES I
1YDLED465MV30B

LUZ SUAVE CÁLIDA
● 3 000 K

Lumens: 37 lm
Potencia: 1 W
Volts: 100-240 V ~

Terminado: **Blanco**
IRC: **80**
Vida útil: **25 000 h**
Ángulo: **73 °**
Tipo de lámpara: **LED (Integrado)**
Incluye: **Driver LED**
Corte de empotramiento: **123 mm x 123 mm**
Atenuable: **No**

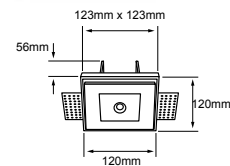

CERVANTES II
1YDLED466MV30B

LUZ SUAVE CÁLIDA
● 3 000 K

Lumens: 32 lm
Potencia: 1 W
Volts: 100-240 V ~

Terminado: **Blanco**
IRC: **80**
Vida útil: **25 000 h**
Ángulo: **73 °**
Tipo de lámpara: **LED (Integrado)**
Incluye: **Driver LED**
Corte de empotramiento: **123 mm x 123 mm**
Atenuable: **No**

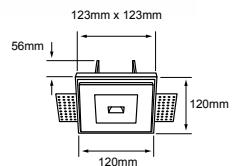

CERVANTES III
1YDLED467MV30B

LUZ SUAVE CÁLIDA
● 3 000 K

Lumens: 27 lm
Potencia: 1 W
Volts: 100-240 V ~

Terminado: **Blanco**
IRC: **80**
Vida útil: **25 000 h**
Ángulo: **88 °**
Tipo de lámpara: **LED (Integrado)**
Incluye: **Driver LED**
Corte de empotramiento: **123 mm x 123 mm**
Atenuable: **No**

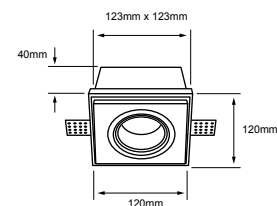

CANES
60YD453MVB

Potencia máx: 60 W
Volts: 100-240 V ~

Terminado: **Blanco**
Tipo de base: **GX5.3**

Atenuable: **No**
Tipo de lámpara: **MR16 (No incluida)**
Corte de empotramiento: **123 mm x 123 mm**

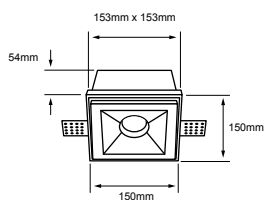

CHALAWAN I
60YD454MVBN

Potencia máx: 60 W
Volts: 100-240 V ~

Terminado: **Blanco**
Tipo de base: **GX5.3**

Atenuable: **No**
Tipo de lámpara: **MR16 (No incluida)**
Corte de empotramiento: **153 mm x 153 mm**

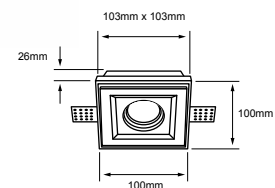

CHERTAN I
60YD459MVB

Potencia máx: 60 W
Volts: 100-240 V ~

Terminado: **Blanco**
Tipo de base: **GX5.3**

Atenuable: **No**
Tipo de lámpara: **MR16 (No incluida)**
Corte de empotramiento: **103 mm x 103 mm**

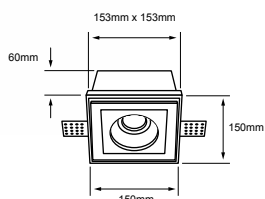

CHALAWAN II
60YD455MVBN

Potencia máx: 60 W
Volts: 100-240 V ~

Terminado: **Blanco**
Tipo de base: **GX5.3**

Atenuable: **No**
Tipo de lámpara: **MR16 (No incluida)**
Corte de empotramiento: **153 mm x 153 mm**

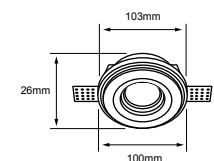

CHERTAN II
60YD460MVB

Potencia máx: 60 W
Volts: 100-240 V ~

Terminado: **Blanco**
Tipo de base: **GX5.3**

Atenuable: **No**
Tipo de lámpara: **MR16 (No incluida)**
Corte de empotramiento: **Diametro 103 mm**

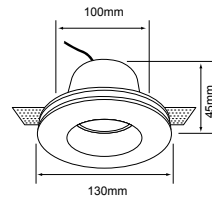

AHMEDABAD
YD-440

Potencia máx.: 60 W
Volts: 100-240 V ~ / 12 V ~

Terminado: Blanco
Tipo de base: GX5.3
Tipo de lámpara: MR16 (No incluida)
Corte de empotramiento: 100 mm

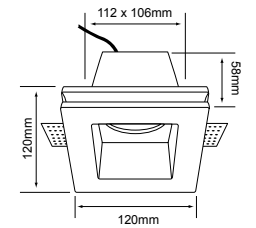

AHMEDABAD I
YD-441

Potencia máx.: 60 W
Volts: 100-240 V ~ / 12 V ~

Terminado: Blanco
Tipo de base: GX5.3
Tipo de lámpara: MR16 (No incluida)
Corte de empotramiento: 112 mm x 106 mm

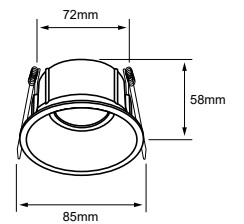

URANIUM I
10YDR002MVB

Potencia máx.: 60 W
Volts: 100-240 V ~ / 12 V ~

Terminado: Blanco
Tipo de base: GX5.3
Tipo de lámpara: MR16 (No incluida)
Corte de empotramiento: 72 mm
Dirigible

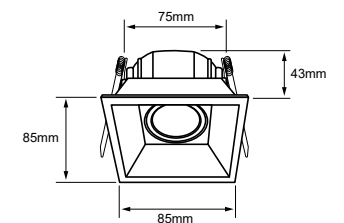

URANIUM II
10YDC002MVB

Potencia máx.: 60 W
Volts: 100-240 V ~ / 12 V ~

Terminado: Blanco
Tipo de base: GX5.3
Tipo de lámpara: MR16 (No incluida)
Corte de empotramiento: 75 mm
Dirigible

*Revoque o Mancillado
*Tecnolite se reserva el derecho de modificar la información sin previo aviso y no se hace responsable por errores u omisiones en este documento.
*Lámparas y luminarios no aptos para trabajo de voltaje constante en niveles superiores o inferiores marcados en el producto.



ABEBA
YDCLED-300/B
Blanco

YDCLED-300/S
Satinado

LUZ SUAVE CÁLIDA
● 3 000 K
Lumens: 200 lm
Potencia: 4 W
Volts: 100-240 V ~

IRC: 80
Vida útil: **25 000 h**
Ángulo: 38 °
Tipo de lámpara: LED (Integrado)
Corte de empotramiento: 46 mm
Atenuable: No
Dirigible



ADELAIDE
YDCLED-305/B
Blanco

YDCLED-305/S
Satinado

LUZ SUAVE CÁLIDA
● 3 000 K
Lumens: 200 lm
Potencia: 4 W
Volts: 100-240 V ~

IRC: 80
Vida útil: **25 000 h**
Ángulo: 38 °
Tipo de lámpara: LED (Integrado)
Corte de empotramiento: 39 mm
Atenuable: No



IOTA
3DYDLED801V30B
Blanco

3DYDLED801V30N
Negro

LUZ SUAVE CÁLIDA
● 3 000 K
Lumens: 120 lm
Potencia: 3 W
Volts: 100-127 V ~

IRC: 80
Vida útil: **15 000 h**
Ángulo: 90 °
Corte de empotramiento: 41 mm
Atenuable: Si
Dirigible



AKABA
YDCLED-315/B
Blanco

YDCLED-315/S
Satinado

LUZ SUAVE CÁLIDA
● 3 000 K
Lumens: 200 lm
Potencia: 4 W
Volts: 100-240 V ~

IRC: 80
Vida útil: **25 000 h**
Ángulo: 38 °
Tipo de lámpara: LED (Integrado)
Corte de empotramiento: 39 mm
Atenuable: No



NUEVO
KALAUSI I
4YDLED1080MV30B

LUZ SUAVE CÁLIDA
● 3 000 K
Lumens: 342 lm
Potencia: 4 W
Volts: 100-240 V ~

Terminado: Blanco / Cromo
IRC: 90
Vida útil: **30 000 h**
Ángulo: 30 °
Tipo de lámpara: LED (Integrado)
Corte de empotramiento: 65 mm
IP: 20
Atenuable: No



NUEVO
KALAUSI II
6YDLED1081MV30B

LUZ SUAVE CÁLIDA
● 3 000 K
Lumens: 446 lm
Potencia: 6 W
Volts: 100-240 V ~

Terminado: Blanco / Cromo
IRC: 90
Vida útil: **30 000 h**
Ángulo: 30 °
Tipo de lámpara: LED (Integrado)
Corte de empotramiento: 75 mm
IP: 20
Atenuable: No



NUEVO
KALAUSI III
6YDLED1082MV30B

LUZ SUAVE CÁLIDA
● 3 000 K
Lumens: 381 lm
Potencia: 6 W
Volts: 100-240 V ~

Terminado: Blanco / Transparente
IRC: 90
Vida útil: **30 000 h**
Ángulo: 30 °
Tipo de lámpara: LED (Integrado)
Corte de empotramiento: 75 mm
IP: 20
Atenuable: No

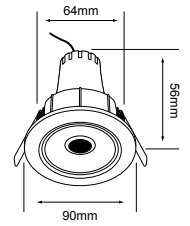
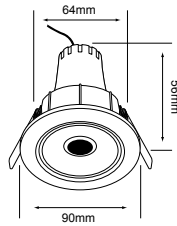

NAOS

YDLED-153/30/B
LUZ SUAVE CÁLIDA
● 3 000 K

Lumens: **250 lm**
Potencia: **3.5 W**
Volts: 100-240 V ~

YDLED-153/40/B
LUZ BLANCA NEUTRA
○ 4 000 K

Terminado: **Blanco**
IRC: 70
Vida útil: **15 000 h**
Ángulo: 68 °

YDLED-153/65/B
LUZ DE DÍA
● 6 500 K

Tipo de lámpara: **LED (Integrado)**
Corte de empotramiento: **64 mm**
Atenuable: **No**
Dirigible

NAOS I

YDLED-154/30/B
LUZ SUAVE CÁLIDA
● 3 000 K

Lumens: **450 lm**
Potencia: **5.5 W**
Volts: 100-240 V ~

YDLED-154/40/B
LUZ BLANCA NEUTRA
○ 4 000 K

Terminado: **Blanco**
IRC: 70
Vida útil: **15 000 h**
Ángulo: 68 °

YDLED-154/65/B
LUZ DE DÍA
● 6 500 K

Tipo de lámpara: **LED (Integrado)**
Corte de empotramiento: **64 mm**
Atenuable: **No**
Dirigible

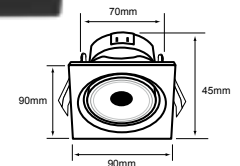
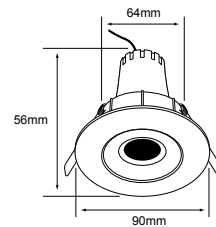

NAOS II

5YDLED154MV30S
LUZ SUAVE CÁLIDA
● 3 000 K

Lumens: **450 lm**
Potencia: **5.5 W**
Volts: 100-240 V ~

5YDLED154MV40S
LUZ BLANCA NEUTRA
○ 4 000 K

Terminado: **Satinado**
IRC: 70
Vida útil: **15 000 h**
Ángulo: 68 °

5YDLED154MV65S
LUZ DE DÍA
● 6 500 K

Tipo de lámpara: **LED (Integrado)**
Corte de empotramiento: **64 mm**
Atenuable: **No**
Dirigible

ALCOR

7YDLED156MV30N Negro
7YDLED156MV30B Blanco
LUZ SUAVE CÁLIDA
● 3 000 K

Lumens: **500 lm**
Potencia: **7 W**
Volts: 100-240 V ~

7YDLED156MV65B Blanco
7YDLED156MV65N Negro
LUZ DE DÍA
● 6 500 K

IRC: 80
Vida útil: **15 000 h**
Ángulo: 38 °
Tipo de lámpara: **LED (integrado)**
Atenuable: **No**
Dirigible

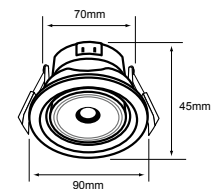

REGULUS

7YDLED155MV30B Blanco
7YDLED155MV30D Dorado
7YDLED155MV30N Negro
7YDLED155MV30S Satinado
LUZ SUAVE CÁLIDA
● 3 000 K

Lumens: **500 lm**
Potencia: **7 W**
Volts: 100-240 V ~

7YDLED155MV65B Blanco
7YDLED155MV65N Negro
LUZ DE DÍA
● 6 500 K

IRC: 80
Vida útil: **15 000 h**
Ángulo: 38 °
Tipo de lámpara: **LED (integrado)**
Atenuable: **No**
Dirigible



B



N

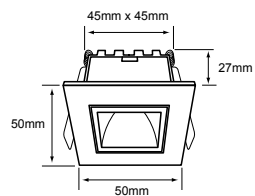

LUCIDA I

3YDLED3161MV30B
Blanco

LUZ SUAVE CÁLIDA
● 3 000 K

Lumens: **115 lm**
Potencia: 3 W
Volts: 100-240 V ~

3YDLED3161MV30N
Negro

IRC: 80
Vida útil: **30 000 h**
Ángulo: 34 °
Tipo de lámpara: LED (Integrado)
Corte de empotramiento: 45 mm x 45 mm
Atenuable: No



N

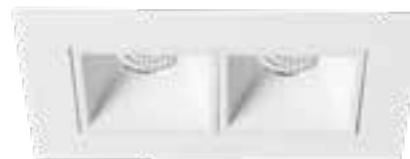

B

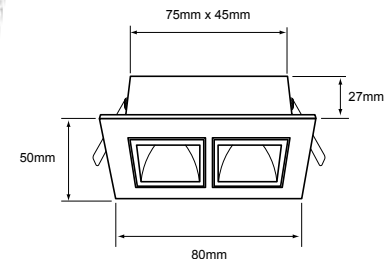

LUCIDA II

6YDLED3162MV30B
Blanco

LUZ SUAVE CÁLIDA
● 3 000 K

Lumens: **235 lm**
Potencia: 6 W
Volts: 100-240 V ~

6YDLED3162MV30N
Negro

IRC: 80
Vida útil: **30 000 h**
Ángulo: 34 °
Tipo de lámpara: LED (Integrado)
Corte de empotramiento: 75 mm x 45 mm
Atenuable: No



N



N



B



B

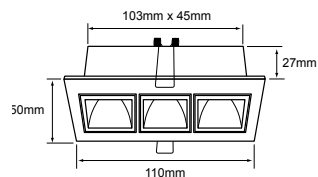

LUCIDA III

7YDLED3163MV30B
Blanco

LUZ SUAVE CÁLIDA
● 3 000 K

Lumens: **305 lm**
Potencia: 7 W
Volts: 100-240 V ~

7YDLED3163MV30N
Negro

IRC: 80
Vida útil: **30 000 h**
Ángulo: 34 °
Tipo de lámpara: LED (Integrado)
Corte de empotramiento: 103 mm x 45 mm
Atenuable: No

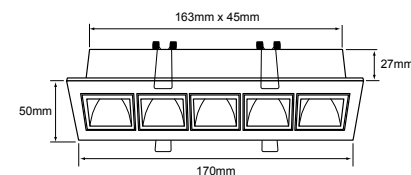

LUCIDA IV

17YDLED3165MV30B
Blanco

LUZ SUAVE CÁLIDA
● 3 000 K

Lumens: **730 lm**
Potencia: 17 W
Volts: 100-240 V ~

17YDLED3165MV30N
Negro

IRC: 80
Vida útil: **30 000 h**
Ángulo: 34 °
Tipo de lámpara: LED (Integrado)
Corte de empotramiento: 163 mm x 45 mm
Atenuable: No



BEAUVAIS
YDLED-800/30
LUZ SUAVE CÁLIDA
● 3 000 K

Lumens: **350 lm**
Potencia: 4.5 W
Volts: 100-240 V ~

YDLED-800/40
LUZ BLANCA NEUTRA
○ 4 000 K

Terminado: **Blanco**
IRC: **80**
Vida útil: **25 000 h**
Ángulo: **100 °**
Tipo de lámpara: **LED (Integrado)**
Corte de empotramiento: **57 mm**
Atenuable: **No**

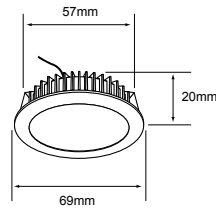

LITA I
6YDLED1070MV27B

LUZ SUAVE CÁLIDA
● 2 700 K

Lumens: **450 lm**
Potencia: 6.5 W
Volts: 127-277 V ~

6YDLED1070V27B

LUZ SUAVE CÁLIDA
● 2 700 K

Lumens: **450 lm**
Potencia: 6.5 W
Volts: 127 V ~

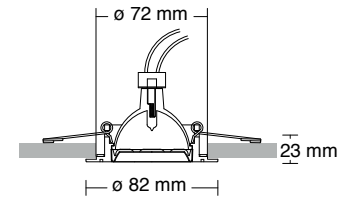

Terminado: **Blanco**
Incluye: **LED MR16 6.5W**
Tipo de lámpara: **GX5.3**
IRC: **80**
Vida útil: **25 000 h**
Ángulo: **36 °**
Corte de empotramiento: **72 mm**
Atenuable: **No**



LITA II
3YDLED1086MV27B

LUZ SUAVE CÁLIDA
● 2 700 K

Lumens: **270 lm**
Potencia: 3 W
Volts: 127-220 V ~

Terminado: **Blanco**
Tipo de lámpara: **LED (Integrado)**
IRC: **80**
Vida útil: **25 000 h**
Ángulo: **24 °**
Corte de empotramiento: **55 mm**
Atenuable: **No**

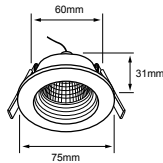

ALTAIR I
YDLED-101/08/30B

LUZ SUAVE CÁLIDA
● 3 000 K

Lumens: **540 lm**
Potencia: 6.5 W
Volts: 100-240 V ~

Terminado: **Blanco**
IRC: **80**
Vida útil: **15 000 h**
Ángulo: **25 °**
Tipo de lámpara: **LED (Integrado)**
Corte de empotramiento: **80 mm**
Atenuable: **No**

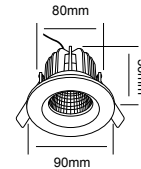

ALTAIR II
YDLED-102/08/30B

LUZ SUAVE CÁLIDA
● 3 000 K

Lumens: **540 lm**
Potencia: 6.5 W
Volts: 100-240 V ~

Terminado: **Blanco**
IRC: **80**
Vida útil: **15 000 h**
Ángulo: **25 °**
Tipo de lámpara: **LED (Integrado)**
Corte de empotramiento: **85 mm**
Atenuable: **No**
Dirigible

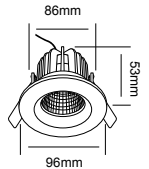

ALHENA
13DYDLED202V30B

LUZ SUAVE CÁLIDA
● 3 000 K

Lumens: **900 lm**
Potencia: 13 W
Volts: 127 V ~

Terminado: **Blanco**
Tipo de lámpara: **LED (integrado)**
IRC: **80**
Vida útil: **30 000 h**
Ángulo: **90 °**
Atenuable: **Si**

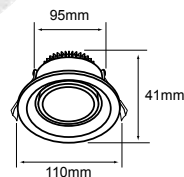

MODULARE I
17YDLED1001MV27B

LUZ SUAVE CÁLIDA
● 2 700 K

Lumens: **1360 lm**
Potencia: 17 W
Volts: 127-277 V ~

Terminado: **Blanco**
Incluye: **LED MR16 6.5W**
Tipo de lámpara: **LED (Integrado)**
IRC: **80**
Vida útil: **25 000 h**
Ángulo: **24 °**
Atenuable: **No**



ALFA
YDLED-810/30

LUZ SUAVE CÁLIDA
● 3 000 K

Lumens: **450 lm**
Potencia: 6 W
Volts: 100-240 V ~

Terminado: **Blanco**
IRC: **80**
Vida útil: **30 000 h**
Ángulo: **110 °**
Tipo de lámpara: **LED (Integrado)**
Corte de empotramiento: **110 mm**
Atenuable: **No**

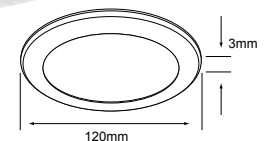



ATIK I
10DYDLED010VSCCTB

TEMPERATURA DE COLOR AJUSTABLE
●○● 2 700 K - 4 000 K - 6 000 K

Lumens: **700 - 830 lm**
Potencia: **10 W**
Volts: **127 V ~**

Terminado: **Blanco**
Tipo de lámpara: **LED (integrado)**
IRC: **80**
Vida útil: **30 000 h**
Ángulo: **90 °**
Atenuable: **Si**
Temperatura ajustable con switch integrado

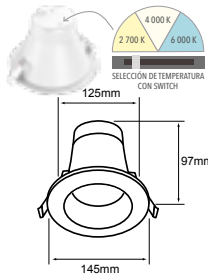

ATIK II
13DYDLED011VSCCTB

TEMPERATURA DE COLOR AJUSTABLE
●○● 2 700 K - 4 000 K - 6 000 K

Lumens: **1 015 - 1 140 lm**
Potencia: **13 W**
Volts: **127 V ~**

Terminado: **Blanco**
Tipo de lámpara: **LED (integrado)**
IRC: **80**
Vida útil: **30 000 h**
Ángulo: **90 °**
Atenuable: **Si**
Temperatura ajustable con switch integrado

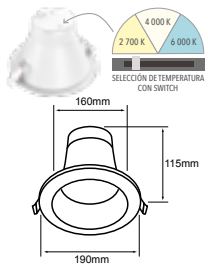

ATIK III
16DYDLED012VSCCTB

TEMPERATURA DE COLOR AJUSTABLE
●○● 2 700 K - 4 000 K - 6 000 K

Lumens: **1 480 - 1 660 lm**
Potencia: **16 W**
Volts: **127 V ~**

Terminado: **Blanco**
Tipo de lámpara: **LED (integrado)**
IRC: **80**
Vida útil: **30 000 h**
Ángulo: **90 °**
Atenuable: **Si**
Temperatura ajustable con switch integrado

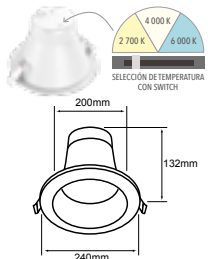

ATIK IV
20DYDLED013VSCCTB

TEMPERATURA DE COLOR AJUSTABLE
●○● 2 700 K - 4 000 K - 6 000 K

Lumens: **1 880 - 2 060 lm**
Potencia: **20 W**
Volts: **127 V ~**

Terminado: **Blanco**
Tipo de lámpara: **LED (integrado)**
IRC: **80**
Vida útil: **30 000 h**
Ángulo: **90 °**
Atenuable: **Si**
Temperatura ajustable con switch integrado

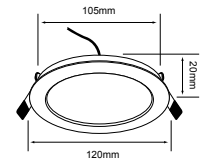

BUCARAMANGA VI
6DYDLED430MV30B
LUZ SUAVE CÁLIDA
● 3 000 K

Lumens: **320 lm**
Potencia: **6 W**
Volts: **100-240 V ~**

6DYDLED430MV40B
LUZ BLANCA NEUTRA
○ 4 000 K

Terminado: **Blanco**
IRC: **70**
Vida útil: **15 000 h**
Ángulo: **120 °**
Tipo de lámpara: **LED (Integrado)**
Corte de empotramiento: **105 mm**
Atenuable: **No**

6DYDLED430MV65B
LUZ DE DÍA
● 6 500 K

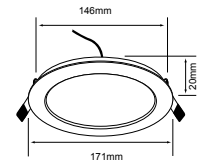

BUCARAMANGA VII
12DYDLED430MV30B
LUZ SUAVE CÁLIDA
● 3 000 K

Lumens: **720 lm**
Potencia: **12 W**
Volts: **100-240 V ~**

12DYDLED430MV40B
LUZ BLANCA NEUTRA
○ 4 000 K

Terminado: **Blanco**
IRC: **70**
Vida útil: **15 000 h**
Ángulo: **120 °**
Tipo de lámpara: **LED (Integrado)**
Corte de empotramiento: **146 mm**
Atenuable: **No**

12DYDLED430MV65B
LUZ DE DÍA
● 6 500 K

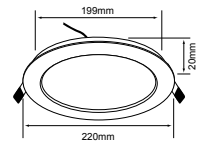

BUCARAMANGA VIII
18DYDLED430MV30B
LUZ SUAVE CÁLIDA
● 3 000 K

Lumens: **1 200 lm**
Potencia: **18 W**
Volts: **100-240 V ~**

18DYDLED430MV40B
LUZ BLANCA NEUTRA
○ 4 000 K

Terminado: **Blanco**
IRC: **70**
Vida útil: **15 000 h**
Ángulo: **120 °**
Tipo de lámpara: **LED (Integrado)**
Corte de empotramiento: **199 mm**
Atenuable: **No**

18DYDLED430MV65B
LUZ DE DÍA
● 6 500 K

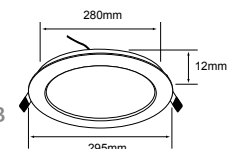

BUCARAMANGA IX
24DYDLED430MV30B
LUZ SUAVE CÁLIDA
● 3 000 K

Lumens: **1 600 lm**
Potencia: **24 W**
Volts: **100-240 V ~**

24DYDLED430MV65B
LUZ DE DÍA
● 6 500 K

Terminado: **Blanco**
Tipo de lámpara: **LED (integrado)**
IRC: **80**
Vida útil: **15 000 h**
Ángulo: **150 °**
Atenuable: **No**

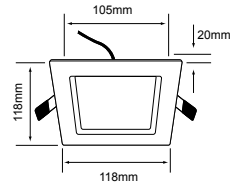

BRIGHTON VI
6YDLED431MV30B
 LUZ SUAVE CÁLIDA
 ● 3 000 K

Lumens: 320 lm
Potencia: 6 W
Volts: 100-240 V ~

6YDLED431MV65B
 LUZ DE DÍA
 ● 6 500 K

Terminado: **Blanco**
 IRC: **70**
 Vida útil: **15 000 h**
 Ángulo: **120 °**
 Tipo de lámpara: **LED (Integrado)**
 Corte de empotramiento: **105 mm**
 Atenuable: **No**

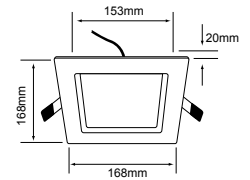

BRIGHTON VII
12YDLED431MV30B
 LUZ SUAVE CÁLIDA
 ● 3 000 K

Lumens: 720 lm
Potencia: 12 W
Volts: 100-240 V ~

12YDLED431MV65B
 LUZ DE DÍA
 ● 6 500 K

Terminado: **Blanco**
 IRC: **70**
 Vida útil: **15 000 h**
 Ángulo: **120 °**
 Tipo de lámpara: **LED (Integrado)**
 Corte de empotramiento: **153 mm**
 Atenuable: **No**

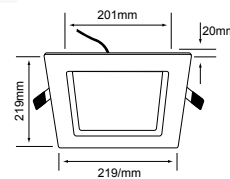

BRIGHTON VIII
18YDLED431MV30B
 LUZ SUAVE CÁLIDA
 ● 3 000 K

Lumens: 1 200 lm
Potencia: 18 W
Volts: 100-240 V ~

18YDLED431MV65B
 LUZ DE DÍA
 ● 6 500 K

Terminado: **Blanco**
 IRC: **70**
 Vida útil: **15 000 h**
 Ángulo: **120 °**
 Tipo de lámpara: **LED (Integrado)**
 Corte de empotramiento: **201 mm**
 Atenuable: **No**

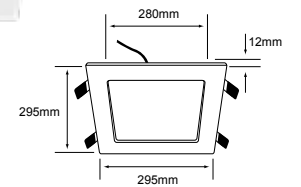

BRIGHTON IX
24YDLED431MV30B
 LUZ SUAVE CÁLIDA
 ● 3 000 K

Lumens: 1 600 lm
Potencia: 24 W
Volts: 100-240 V ~

24YDLED431MV65B
 LUZ DE DÍA
 ● 6 500 K

Terminado: **Blanco**
 Tipo de lámpara: **LED (integrado)**
 IRC: **80**
 Vida útil: **15 000 h**
 Ángulo: **150 °**
 Atenuable: **No**

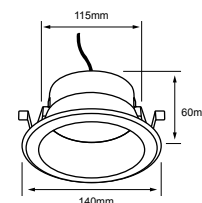

NUEVO

KAMUY

20YDLED015MV30B Blanco

Lumens: **1 620 lm**

20YDLED015MV30N Negro

Lumens: **1 440 lm**

LUZ SUAVE CÁLIDA
● 3 000 K

20YDLED015MV40B Blanco

Lumens: **1 800 lm**

20YDLED015MV40N Negro

Lumens: **1 600 lm**

LUZ BLANCA NEUTRA
○ 4 000 K

20YDLED015MV65B Blanco

20YDLED015MV65N Negro

Lumens: **1 600 lm**

LUZ DE DÍA
● 6 500 K

Potencia: 20 W
Volts: 100-277 V ~

IRC: 80
Vida útil: **25 000 h**
Ángulo: 90 °

Tipo de lámpara: LED (Integrado)
Corte de empotramiento: 115 mm
Atenuable: No

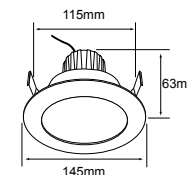
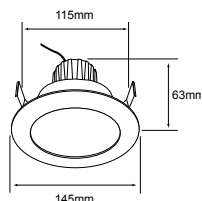

NOVA

YDLED-432/30

LUZ SUAVE CÁLIDA

● 3 000 K

YDLED-432/40

LUZ BLANCA NEUTRA

○ 4 000 K

YDLED-432/65

LUZ DE DÍA

● 6 500 K

Lumens: **800 lm**
Potencia: 11 W
Volts: 100-240 V ~

Terminado: Blanco
IRC: 80
Vida útil: **15 000 h**
Ángulo: 100 °

Tipo de lámpara: LED (Integrado)
Corte de empotramiento: 115 mm
Atenuable: No
Para falso plafón o bote integral 8 cm mínimo

NOVA I

11YDLED432MV30N

LUZ SUAVE CÁLIDA

● 3 000 K

11YDLED432MV65N

LUZ DE DÍA

● 6 500 K

Lumens: **800 lm**
Potencia: 11 W
Volts: 100-240 V ~

Terminado: Negro
IRC: 80
Vida útil: **15 000 h**
Ángulo: 100 °

Tipo de lámpara: LED (Integrado)
Corte de empotramiento: 115 mm
Atenuable: No
Para falso plafón o bote integral 8 cm mínimo

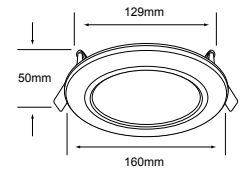
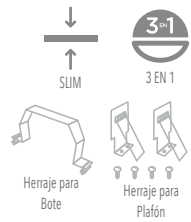

MUNICH
YDLED-15RD/9W/40B
Blanco

YDLED-15RD/9W/40S
Satinado

LUZ BLANCA NEUTRA
○ 4 000 K

IRC: 80
Vida útil: **25 000 h**
Ángulo: 110°

Tipo de lámpara: LED (Integrado)
Corte de empotramiento: 129 mm
Atenuable: No
Para bote integral 8 cm mínimo

Lumens: **500 lm**
Potencia: 9 W
Volts: 127 V ~

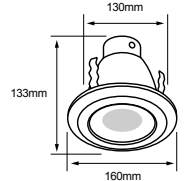
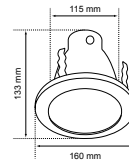

OLMO
YDLED-1500/30/B
Blanco
LUZ SUAVE CÁLIDA
○ 3 000 K

YDLED-1500/65/B
Blanco
LUZ DE DÍA
● 6 500 K

YDLED-1500/30/S
Satinado
LUZ SUAVE CÁLIDA
○ 3 000 K

YDLED-1500/65/S
Satinado
LUZ DE DÍA
● 6 500 K

8YDLED1500EPMV30B
Blanco
LUZ SUAVE CÁLIDA
○ 3 000 K

8YDLED1500EPMV65B
Blanco
LUZ DE DÍA
● 6 500 K

Lumens: **800 lm**
Potencia: 8.5 W
Volts: 100-240 V ~

IRC: 80
Vida útil: **15 000 h**
Tipo de base: E27
Ángulo: 75°

Tipo de lámpara: Led 8.5 W (Incluida)
Corte de empotramiento: 115 mm
Atenuable: No

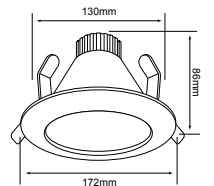
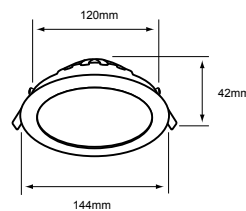

VOLANS I
09YDMLED001MV40B Blanco
09YDMLED001MV40S Satinado
LUZ BLANCA NEUTRA
○ 4 000 K

09YDMLED001MV65B Blanco
09YDMLED001MV65S Satinado
LUZ DE DÍA
● 6 500 K

Lumens: **800 lm**
Potencia: 9 W
Volts: 100-240 V ~

IRC: 80
Vida útil: **15 000 h**
Ángulo: 120°

Tipo de lámpara: LED (Integrado)
Corte de empotramiento: 120 mm
Atenuable: No

NADI
YDMLED-1508/30/B Blanco
YDMLED-1508/30/S Satinado
LUZ SUAVE CÁLIDA
○ 3 000 K

YDMLED-1508/65/B Blanco
YDMLED-1508/65/S Satinado
LUZ DE DÍA
● 6 500 K

Lumens: **700 lm**
Potencia: 9 W
Volts: 100-240 V ~

IRC: 80
Vida útil: **20 000 h**
Ángulo: 110°
Tipo de base: E27

Tipo de lámpara: LED 9 W (Incluida)
Corte de empotramiento: 130 mm
Atenuable: No
Para bote integral 8 cm mínimo



ATENUABLE

ALIOTH I

YDLEDD-004/30

LUZ SUAVE CÁLIDA

● 3 000 K

Lumens: **1 100 lm**

YDLEDD-004/40

LUZ BLANCA NEUTRA

○ 4 000 K

Lumens: **1 200 lm**

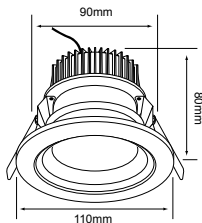

Potencia: 13 W
Volts: 100-127 V ~

IRC: 80
Vida útil: **40 000 h**
Ángulo: 60 °

Tipo de lámpara: LED (Integrado)
Corte de empotramiento: 90 mm
Atenuable: Si



ATENUABLE

ALIOTH II

YDLEDD-005/30

LUZ SUAVE CÁLIDA

● 3 000 K

Lumens: **2 300 lm**

YDLEDD-005/40

LUZ BLANCA NEUTRA

○ 4 000 K

Lumens: **2 400 lm**

25DYDLED005V65B

LUZ DE DÍA

● 6 500 K

Lumens: **2 400 lm**

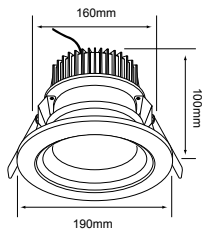

Potencia: 25 W
Volts: 100-127 V ~

Terminado: Blanco
IRC: 80
Vida útil: **40 000 h**
Ángulo: 60 °

Tipo de lámpara: LED (Integrado)
Corte de empotramiento: 160 mm
Atenuable: Si



ATENUABLE

ALIOTH III

YDLEDD-006/30

LUZ SUAVE CÁLIDA

● 3 000 K

Lumens: **3 300 lm**

YDLEDD-006/40

LUZ BLANCA NEUTRA

○ 4 000 K

Lumens: **3 400 lm**

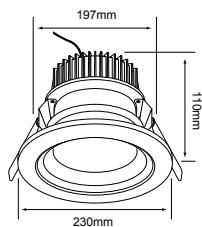

Potencia: 35 W
Volts: 100-127 V ~

Terminado: Blanco
IRC: 80
Vida útil: **40 000 h**
Ángulo: 60 °

Tipo de lámpara: LED (Integrado)
Corte de empotramiento: 197 mm
Atenuable: Si





B



S

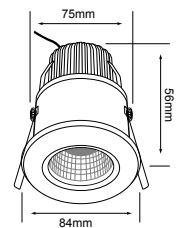

NINFA
YDLED-101/30/B
Blanco

LUZ SUAVE CÁLIDA
● 3 000 K

Lumens: **380 lm**
Potencia: 6.5 W
Volts: 100-240 V ~

YDLED-101/30/S
Satin

Terminado: **Satin**
IRC: **80**
Vida útil: **25 000 h**
Ángulo: 24 °

IP: **44**
Tipo de lámpara: **LED (Integrado)**
Corte de empotramiento: **75 mm**
Atenuable: **No**
A prueba de vapor



B



S



N

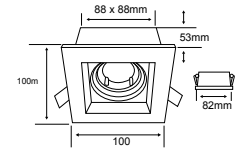

ALCANTE
60YD4001MVB
Blanco

60YD4001MVS
Satinado

60YD4001MVN
Negro

Potencia: 60 W
Volts: 100-240 V ~

Tipo de base: GX5.3/GU10
Tipo de lámpara: MR16/GU10 (No incluida)
Corte de empotramiento: 88 mm x 88 mm
Dirigible



B



S



N

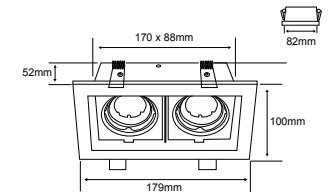

ALCANTE I
120YD4002MVB
Blanco

120YD4002MVS
Satinado

120YD4002MVN
Negro

Potencia: 120 W
Volts: 100-240 V ~

Tipo de base: GX5.3/GU10 x 2
Tipo de lámpara: MR16/GU10 x 2 (No incluida)
Corte de empotramiento: 170 mm x 88 mm
Dirigible



B



S



N

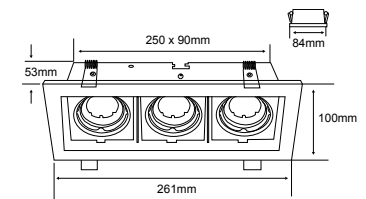

ALCANTE II
180YD4003MVB
Blanco

180YD4003MVS
Satinado

180YD4003MVN
Negro

Potencia: 180 W
Volts: 100-240 V ~

Tipo de base: GX5.3/GU10 x 3
Tipo de lámpara: MR16/GU10 x 3 (No incluida)
Corte de empotramiento: 250 mm x 90 mm
Dirigible

Lámparas a 12 V requiere transformador.



ALULA
20YD510MVBE27
Blanco

Potencia máx.: 50 W
Volts: 100-240 V ~

20YD510MVNE27
Negro

Tipo de base: E27
Tipo de lámpara: PAR 30 (No incluida)
Corte de empotramiento: 160 mm
Dirigible



LUYTEN I
20YD5001MVBE27
Blanco

Potencia máx.: 50 W
Volts: 100-240 V ~

20YD5001MVNE27
Negro

Tipo de base: E27
Tipo de lámpara: PAR 30 (No incluida)
Corte de empotramiento: 150 mm x 150 mm
Dirigible



LUYTEN II
20YD5003MVBE27
Blanco

Potencia máx.: 150 W
Volts: 100-240 V ~

Tipo de base: E27
Tipo de lámpara: PAR 30 (No incluida)
Corte de empotramiento: 472 mm x 150 mm
Dirigible

Lámparas a 12 V requiere transformador.

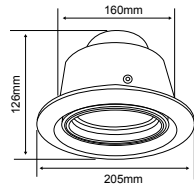

ARESE
YD-510/B

Potencia máx.: 50 W
Volts: 100-240 V ~ / 12 V ~

Terminado: Blanco
Tipo de base: G53
Tipo de lámpara: AR111 (No incluida)
Corte de empotramiento: 160 mm
Dirigible

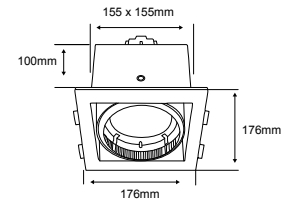

NANCHONG
YD-700-1/N

Potencia: 50 W
Volts: 100-240 V ~ / 12 V ~

Terminado: Negro
Tipo de base: G53
Tipo de lámpara: AR111 (No incluida)
Corte de empotramiento: 155 mm x 155 mm
Dirigible

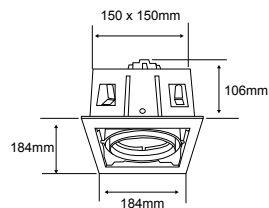

ARCO I
YD-500-1/B

Potencia máx.: 50 W
Volts: 100-240 V ~ / 12 V ~

Terminado: Blanco
Tipo de base: G53
Tipo de lámpara: AR111 (No incluida)
Corte de empotramiento: 150 mm x 150 mm
Dirigible

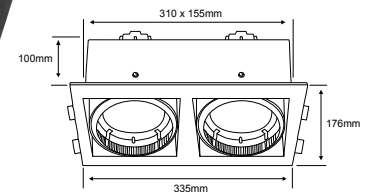

NANCHONG I
YD-700-2/N

Potencia máx.: 100 W
Volts: 100-240 V ~ / 12 V ~

Terminado: Negro
Tipo de base: G53 x 2
Tipo de lámpara: AR111 x 2 (No incluida)
Corte de empotramiento: 310 mm x 155 mm
Dirigible

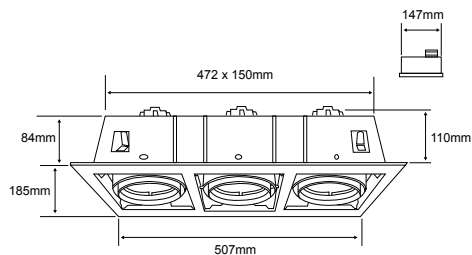

ARCO
YD-500-3/B

Potencia máx.: 150 W
Volts: 100-240 V ~ / 12 V ~

Terminado: Blanco
Tipo de base: G53 x 3
Tipo de lámpara: AR111 x 3 (No incluida)
Corte de empotramiento: 472 mm x 150 mm
Dirigible

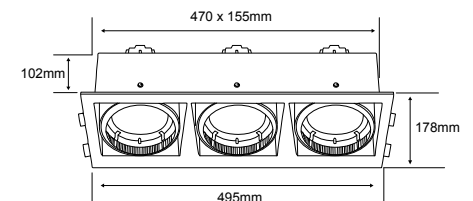

NANCHONG II
YD-700-3/N

Potencia máx.: 150 W
Volts: 100-240 V ~ / 12 V ~

Terminado: Negro
Tipo de base: G53 x 3
Tipo de lámpara: AR111 x 3 (No incluida)
Corte de empotramiento: 470 mm x 155 mm
Dirigible

Lámparas a 12 V requiere transformador.

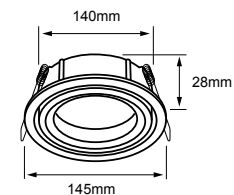

NUEVO
ALSHAIN
60YD4027MVB

Potencia máx.: 60 W
Volts: 100-240 V ~

Terminado: Blanco
Tipo de base: G53
Tipo de lámpara: AR111 (No incluida)

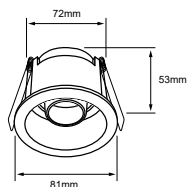

NUEVO
ALASIA I
60YDR1068MVB

Potencia máx.: 60 W
Volts: 100-240 V ~

Terminado: Blanco
Tipo de base: GX5.3
Tipo de lámpara: MR16 (No incluida)
Corte de empotramiento: 75 mm

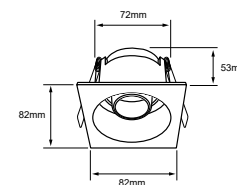

NUEVO
ALASIA II
60YDC1069MVB

Potencia máx.: 60 W
Volts: 100-240 V ~

Terminado: Blanco
Tipo de base: GX5.3
Tipo de lámpara: MR16 (No incluida)
Corte de empotramiento: 75 mm

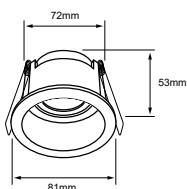

NUEVO
ABSOLUNO I
60YDR1066MVB

Potencia máx.: 60 W
Volts: 100-240 V ~

Terminado: Blanco
Tipo de base: GX5.3
Tipo de lámpara: MR16 (No incluida)
Corte de empotramiento: 75 mm

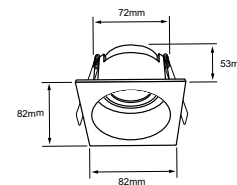

NUEVO
ABSOLUNO II
60YDC1067MVB

Potencia máx.: 60 W
Volts: 100-240 V ~

Terminado: Blanco
Tipo de base: GX5.3
Tipo de lámpara: MR16 (No incluida)
Corte de empotramiento: 75 mm

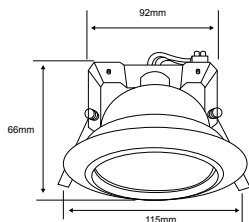

ALATRI
YD-120/B

Potencia máx.: 50 W
Volts: 100-240 V ~ / 12 V ~

Terminado: Blanco
Tipo de base: GY6.35
Tipo de lámpara: JCD (No incluida)
Corte de empotramiento: 92 mm



B

BARI
YDC-350/B
Blanco

Potencia máx.: 35 W
Volts: 100-240 V ~ / 12 V ~



S

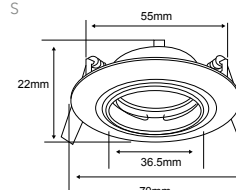

YDC-350/S
Satinado

Tipo de base: G4
Tipo de lámpara: MR11 (No incluida)
Corte de empotramiento: 55 mm
Dirigible



B

S

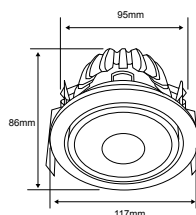

BACCOLI
YD-145/B
Blanco

Potencia máx.: 50 W
Volts: 100-240 V ~ / 12 V ~

YD-145/S
Satinado

Tipo de base: GY6.35
Tipo de lámpara: JCD (No incluida)
Corte de empotramiento: 95 mm



B

ACARI I
YDC-345/B
Blanco

Potencia máx.: 35 W
Volts: 100-240 V ~ / 12 V ~



S

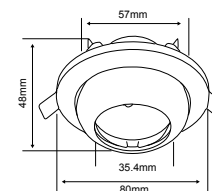

YDC-345/S
Satinado

Tipo de base: G4
Tipo de lámpara: MR11 (No incluida)
Corte de empotramiento: 57 mm
Dirigible



B

ALBA
50YD134VB
Blanco

Potencia máx.: 50 W
Volts: 100-240 V ~ / 12 V ~



S

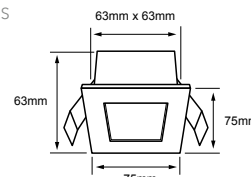

50YD134VS
Satinado

Tipo de base: GY6.35
Tipo de lámpara: JCD (No incluida)
Corte de empotramiento: 62 mm x 62 mm

Lámparas a 12 V requiere transformador.

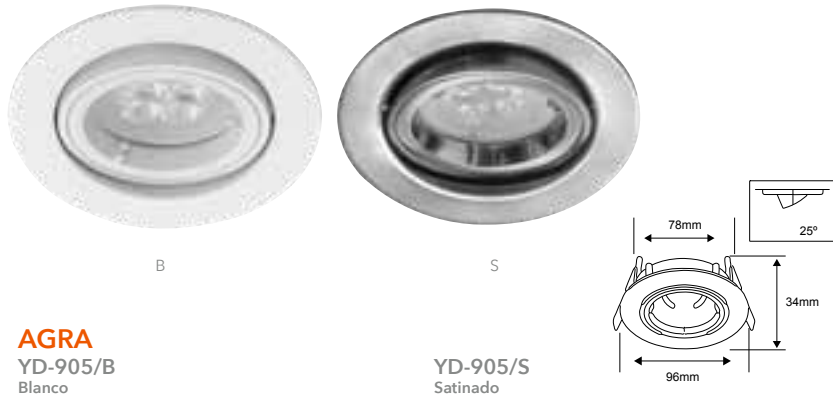

AGRA
YD-905/B
Blanco

Potencia máx.: 50 W
Volts: 100-240 V ~ / 12 V ~

YD-905/S
Satinado

Tipo de base: GX5.3
Tipo de lámpara: MR16 (No incluida)
Corte de empotramiento: 78 mm
Dirigible

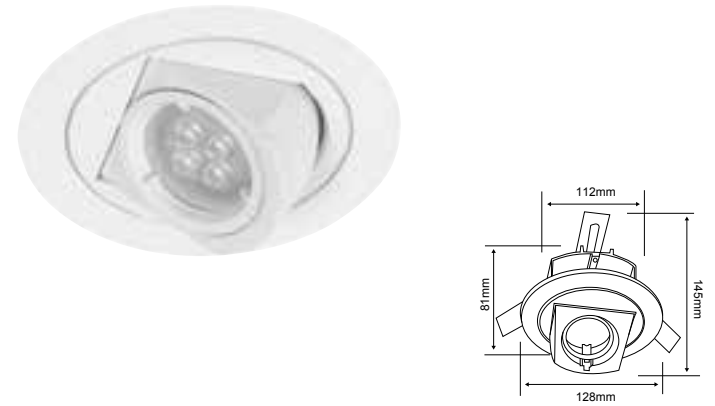

AMELIA
YD-287/B

Potencia máx.: 50 W
Volts: 100-240 V ~ / 12 V ~

Terminado: Blanco
Tipo de base: GX5.3
Tipo de lámpara: MR16 (No incluida)
Corte de empotramiento: 112 mm
Dirigible

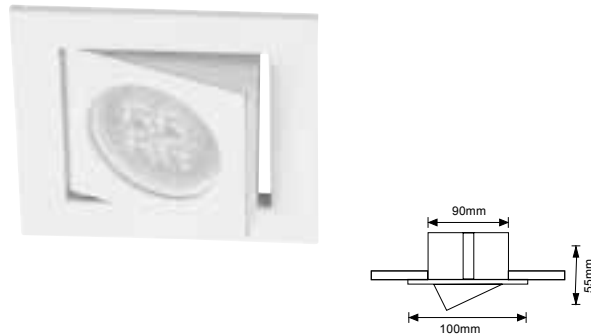

ANZIO
YD-339/B

Potencia máx.: 50 W
Volts: 100-240 V ~ / 12 V ~

Terminado: Blanco
Tipo de base: GX5.3
Tipo de lámpara: MR16 (No incluida)
Corte de empotramiento: 90 mm x 90 mm
Dirigible

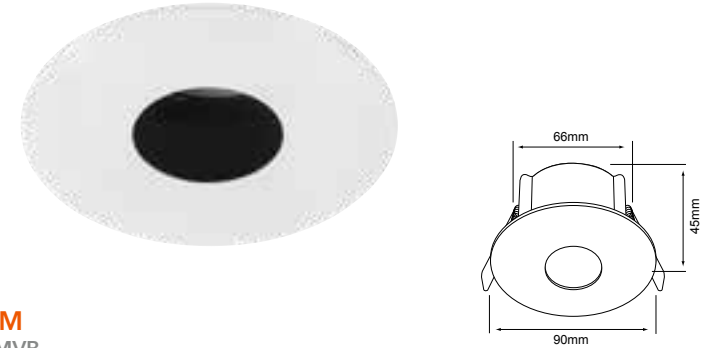

SOLARIUM
10YDR003MVB

Potencia máx.: 50 W
Volts: 100-240/12 V ~

Potencia máx.: 50 W
Volts: 100-240 V ~

Terminado: Blanco
Tipo de base: GX5.3
Tipo de lámpara: MR16 (No incluida)
Corte de empotramiento: 66 mm

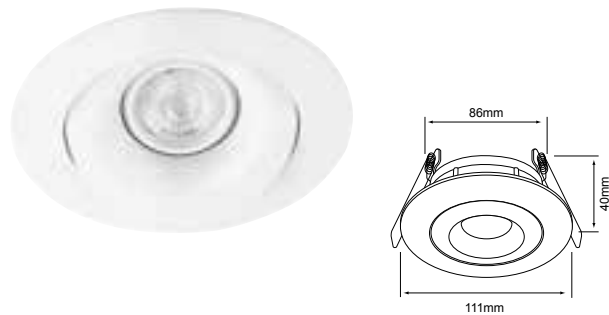

ELISIUM I
10YDR001MVB

Potencia máx.: 50 W
Volts: 100-240 V ~

Terminado: Blanco
Tipo de base: GX5.3
Tipo de lámpara: MR16 (No incluida)
Corte de empotramiento: 86 mm
Dirigible



ELISIUM II
10YDC001MVB

Potencia máx.: 50 W
Volts: 100-240 V ~

Terminado: Blanco
Tipo de base: GX5.3
Tipo de lámpara: MR16 (No incluida)
Corte de empotramiento: 88 mm
Dirigible

Lámparas a 12 V requiere transformador.

*Tecnolite se reserva el derecho de modificar la información sin previo aviso y no se hace responsable por errores u omisiones en este documento.
*Lámparas y luminarios no aptos para trabajo de voltaje constante en niveles superiores o inferiores marcados en el producto.



B



N



S

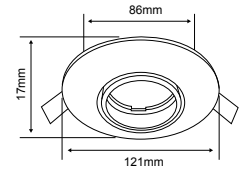

ACERRA

YD-360/B
Blanco

YD-360/N
Negro

YD-360/S
Satinado

Potencia máx.: 50 W
Volts: 100-240 V ~ / 12 V ~

Tipo de base: GX5.3
Tipo de lámpara: MR16 (No incluida)

Corte de empotramiento: 86 mm
Dirigible



B



M



N



O



S

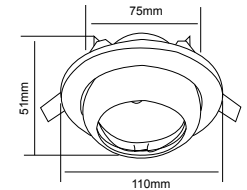

ACARI

YD-345/B
Blanco

YD-345/M
Madera

YD-345/N
Negro

YD-345/O
Latonado

YD-345/S
Satinado

Potencia máx.: 50 W
Volts: 100-240 V ~ / 12 V ~

Tipo de base: GX5.3
Tipo de lámpara: MR16 (No incluida)

Corte de empotramiento: 75 mm
Dirigible



B



N

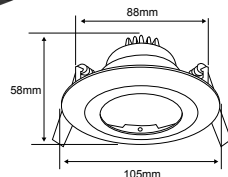

APRICA

YD-341/B
Blanco

YD-341/N
Negro

Potencia máx.: 50 W
Volts: 100-240 V ~ / 12 V ~

Tipo de base: GX5.3
Tipo de lámpara: MR16 (No incluida)
Corte de empotramiento: 88 mm
Dirigible



B



S

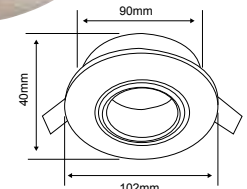

ASTI

YD-515/B
Blanco

YD-515/S
Satinado

Potencia máx.: 50 W
Volts: 100-240 V ~ / 12 V ~

Tipo de base: GX5.3
Tipo de lámpara: MR16 (No incluida)
Corte de empotramiento: 90 mm
Dirigible

Lámparas a 12 V requiere transformador.



B



C



CR



LA



N



O



P



S

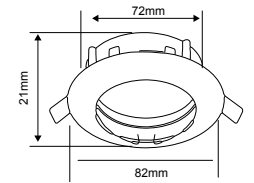

ANDORA

YD-330/B
Blanco

YD-330/C
Cobre

YD-330/CR
Cromado

YD-330/LA
Latón Antiguo

YD-330/N
Negro

YD-330/O
Latonado

YD-330/P
Perlado

YD-330/S
Satinado

Potencia máx.: 50 W
Volts: 100-240 V ~ / 12 V ~

Tipo de base: GX5.3
Tipo de lámpara: MR16 (No incluida)

Corte de empotramiento: 72 mm
Dirigible

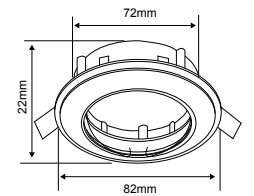

ANDORA

YD-335/S-O

Potencia máx.: 50 W
Volts: 100-240 V ~ / 12 V ~

Terminado: Perlado / Latonado
Tipo de base: GX5.3
Tipo de lámpara: MR16 (No incluida)
Corte de empotramiento: 72 mm
Dirigible

Lámparas a 12 V requiere transformador.



B



D



C



N



S

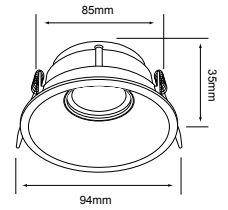

RIGEL
60YD221MVB
Blanco

YD-221/D
60YD221MVD
Dorado

YD-221/C
60YD221MVC
Cobre

60YD221MVN
Negro

YD-221/S
60YD221MVS
Satinado

Potencia máx.: 50 W
Volts: 100-240 V ~ / 12 V ~

Tipo de base: GX5.3
Tipo de lámpara: MR16 (No incluida)

Corte de empotramiento: 85 mm



N



B



O



CR



S



M

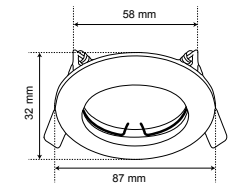

ALEZIO
YD-220/B
Blanco

YD-220/CR
Cromado

YD-220/M
Madera

YD-220/N
Negro

YD-220/O
Latonado

YD-220/S
Satinado

Potencia máx.: 50 W
Volts: 100-240 V ~ / 12 V ~

Tipo de base: GX5.3
Tipo de lámpara: MR16 (No incluida)

Corte de empotramiento: 58 mm

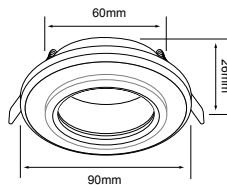

ENIF
YD-224/CE

Potencia máx.: 50 W
Volts: 100-240 V ~ / 12 V ~

Terminado: Cristal espejo
Tipo de base: GX5.3
Tipo de lámpara: MR16 (No incluida)
Corte de empotramiento: 60 mm

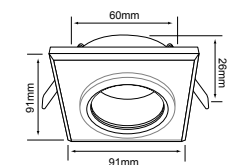

ENIF I
YD-225/CE

Potencia máx.: 50 W
Volts: 100-240 V ~ / 12 V ~

Terminado: Cristal espejo
Tipo de base: GX5.3
Tipo de lámpara: MR16 (No incluida)
Corte de empotramiento: 60 mm

Lámparas a 12 V requiere transformador.

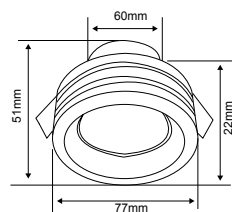

BADESI
YD-600/AL

Potencia máx.: 50 W
Volts: 100-240 V ~ / 12 V ~

Terminado: **Aluminio**
Tipo de base: **GX5.3**
Tipo de lámpara: **MR16 (No incluida)**
Corte de empotramiento: **60 mm**

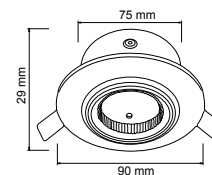

BALLABIA
YD-610/AL

Potencia máx.: 50 W
Volts: 100-240 V ~ / 12 V ~

Terminado: **Aluminio**
Tipo de base: **GX5.3**
Tipo de lámpara: **MR16 (No incluida)**
Corte de empotramiento: **75 mm**
Dirigible

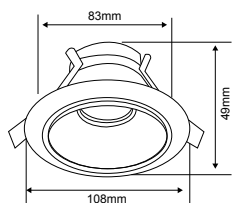

ANGUSTA
YD-525/S

Potencia máx.: 50 W
Volts: 100-240 V ~ / 12 V ~

Terminado: **Satinado**
Tipo de base: **GX5.3**
Tipo de lámpara: **MR16 (No incluida)**
Corte de empotramiento: **83 mm**

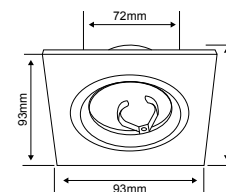

BALME I
YD-620/AL

Potencia máx.: 50 W
Volts: 100-240 V ~ / 12 V ~

Terminado: **Aluminio**
Tipo de base: **GX5.3**
Tipo de lámpara: **MR16 (No incluida)**
Corte de empotramiento: **72 mm**

Lámparas a 12 V requiere transformador.

*Tecnolite se reserva el derecho de modificar la información sin previo aviso y no se hace responsable por errores u omisiones en este documento.
*Lámparas y luminarios no aptos para trabajo de voltaje constante en niveles superiores o inferiores marcados en el producto.



B

NARBONA

YD-1200/B
Blanco

Potencia máx.: 60 W
Volts: 100-240 V ~

Tipo de base: E27
Tipo de lámpara: **OPCIONAL (No incluida)**
Corte de empotramiento: 114 mm



S

YD-1200/S
Satinado

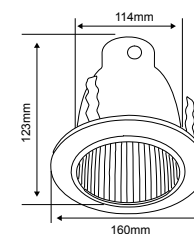

B

AFFI

YD-140/B
Blanco

Potencia máx.: 50 W
Volts: 100-240 V ~ / 12 V ~

Tipo de base: GX5.3
Tipo de lámpara: **MR16 (No incluida)**
Corte de empotramiento: 103 mm



S

YD-140/S
Satinado

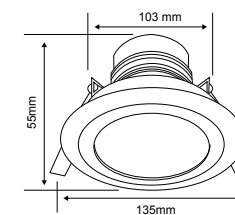

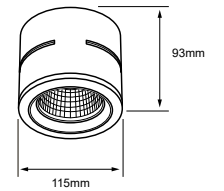

NUEVO
AMADIO
60YSN4024MVB

Potencia máx.: 60 W
Volts: 100-240 V ~

Terminado: Blanco
Tipo de base: G53
Tipo de lámpara: AR111 (No incluida)
IP: 20

INTERIOR / ACENTO / A PRUEBA DE VAPOR

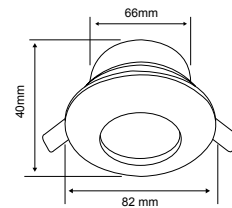

ADRIA I
10YD101MVB
Blanco

Potencia máx.: 50 W
Volts: 100-240 V ~ / 12 V ~

10YD101MVS
Satinado

Tipo de base: GX5.3
Tipo de lámpara: MR16 (No incluida)
Corte de empotramiento: 66 mm
IP: 42
A prueba de vapor

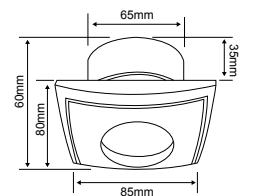

ADRIA II
YD-103/B
Blanco

Potencia máx.: 50 W
Volts: 100-240 V ~ / 12 V ~

YD-103/S
Satinado

Tipo de base: GX5.3
Tipo de lámpara: MR16 (No incluida)
Corte de empotramiento: 65 mm
IP: 42
A prueba de vapor

Lámparas a 12 V requiere transformador.

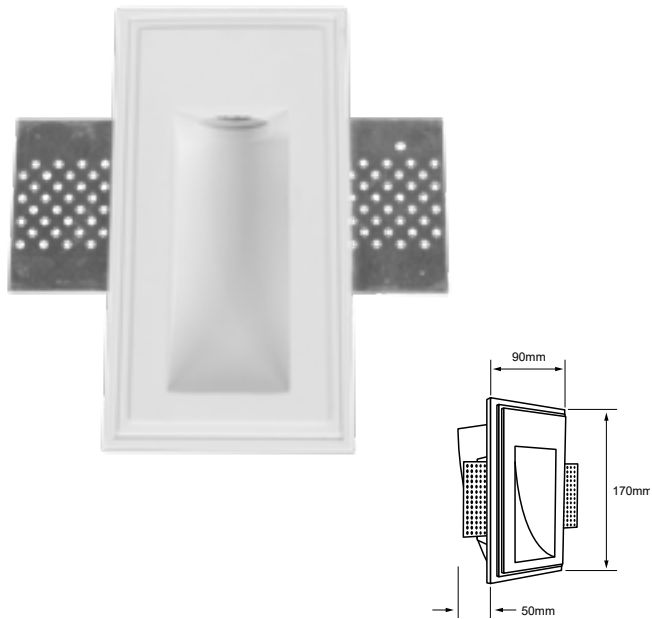

ALNIL I

1ETLLED914MV30B

LUZ SUAVE CÁLIDA
● 3 000 K

Lumens: **48 lm**
Potencia: 1 W
Volts: 100-240 V ~

Terminado: **Blanco**
IRC: **80**
Vida útil: **25 000 h**
Ángulo: 90°

Tipo de lámpara: **LED (Integrado)**
Corte de empotramiento: 175 mm x 170 mm
Atenuable: **No**

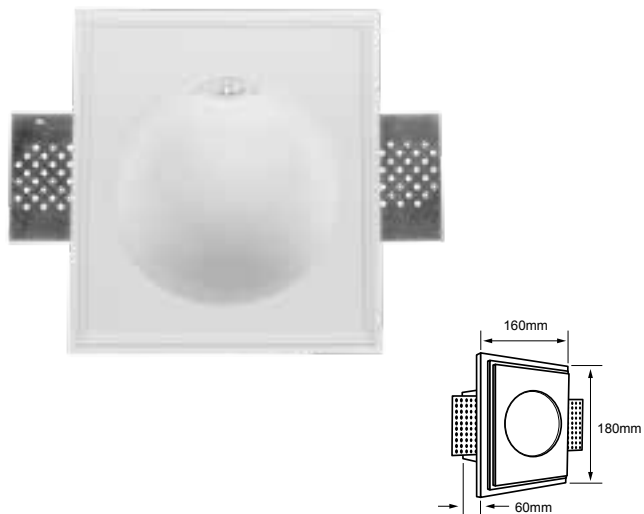

ALNIL I

1ETLLED915MV30B

LUZ SUAVE CÁLIDA
● 3 000 K

Lumens: **50 lm**
Potencia: 1 W
Volts: 100-240 V ~

Terminado: **Blanco**
IRC: **80**
Vida útil: **25 000 h**
Ángulo: 100°

Tipo de lámpara: **LED (Integrado)**
Corte de empotramiento: 240 mm x 190 mm
Atenuable: **No**





B



N

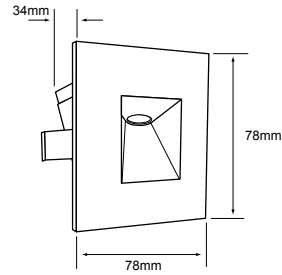

CYRANO
ETLLED-002/30/B
Blanco

LUZ SUAVE CÁLIDA
● 3 000 K

Lumens: 125 lm
Potencia: 3 W
Volts: 100-240 V ~

3ETLLED002MV30N
Negro

IRC: 80
Vida útil: **50 000 h**
Ángulo: 36 °
Tipo de lámpara: LED (Integrado)
Corte de empotramiento: 65 mm
Atenuable: No

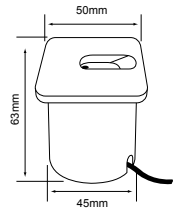

CYRANO II
1ETLLED913MV30B

LUZ SUAVE CÁLIDA
● 3 000 K

Lumens: 20 lm
Potencia: 1 W
Volts: 100-240 V ~

Terminado: **Blanco**
IRC: 70
Vida útil: **15 000 h**
Ángulo: 44 °
Tipo de lámpara: LED (Integrado)
Corte de empotramiento: 45 mm
Atenuable: No



B



N

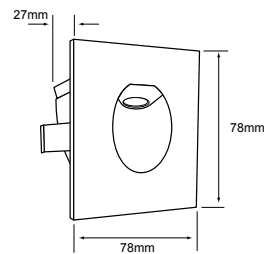

CYNARA
ETLLED-001/30/B
Blanco

LUZ SUAVE CÁLIDA
● 3 000 K

Lumens: 125 lm
Potencia: 3 W
Volts: 100-240 V ~

3ETLLED001MV30N
Negro

IRC: 80
Vida útil: **50 000 h**
Ángulo: 36 °
Tipo de lámpara: LED (Integrado)
Corte de empotramiento: 65 mm
Atenuable: No

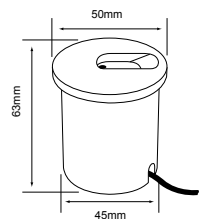

CYNARA II
1ETLLED912MV30B

LUZ SUAVE CÁLIDA
● 3 000 K

Lumens: 20 lm
Potencia: 1 W
Volts: 100-240 V ~

Terminado: **Blanco**
IRC: 70
Vida útil: **15 000 h**
Ángulo: 44 °
Tipo de lámpara: LED (Integrado)
Corte de empotramiento: 45 mm
Atenuable: No



HALLEY I
YSNLED-013/B
Blanco

LUZ SUAVE CÁLIDA
● 3 000 K

Lumens: **1 200 lm**
Potencia: **14.5 W**
Volts: **100-240 V ~**

YSNLED-013/N
Negro

IRC: **80**
Vida útil: **20 000 h**
Ángulo: **38 °**
Tipo de lámpara: **LED (Integrado)**
Atenuable: **No**
Dirigible



INDUS
16YSNLED018MV30B
Blanco

LUZ SUAVE CÁLIDA
● 3 000 K

Lumens: **1 600 lm**
Potencia: **16 W**
Volts: **100-240 V ~**

16YSNLED018MV30N
Negro

IRC: **80**
Vida útil: **20 000 h**
Ángulo: **38 °**
Tipo de lámpara: **LED (Integrado)**
Atenuable: **No**
Dirigible



PICTORIS
YSNLED-015/B

LUZ SUAVE CÁLIDA
● 3 000 K

Lumens: **1 000 lm**
Potencia: **15 W**
Volts: **100-240 V ~**

Terminado: **Blanco**
IRC: **80**
Vida útil: **20 000 h**
Ángulo: **36 °**
Tipo de lámpara: **LED (Integrado)**
Atenuable: **No**
Dirigible



INDUS I
22YSNLED019MV30B
Blanco

LUZ SUAVE CÁLIDA
● 3 000 K

Lumens: **2 200 lm**
Potencia: **22 W**
Volts: **100-240 V ~**

22YSNLED019MV30N
Negro

IRC: **80**
Vida útil: **20 000 h**
Ángulo: **38 °**
Tipo de lámpara: **LED (Integrado)**
Atenuable: **No**
Dirigible



ASELLUS I
7YSNLED020MV30B
Blanco

LUZ SUAVE CÁLIDA
● 3 000 K

Lumens: **250 lm**
Potencia: 7 W
Volts: 100-240 V ~

7YSNLED020MV30N
Negro

IRC: 90
Vida útil: **30 000 h**
Ángulo: 24 °
Tipo de lámpara: LED (Integrado)
Atenuable: No
Giratorio / Dirigible



HALLEY
YSNLED-012/B
Blanco

LUZ SUAVE CÁLIDA
● 3 000 K

Lumens: **500 lm**
Potencia: 7.5 W
Volts: 100-240 V ~

YSNLED-012/N
Negro

IRC: 80
Vida útil: **20 000 h**
Ángulo: 38 °
Tipo de lámpara: LED (Integrado)
Atenuable: No
Dirigible

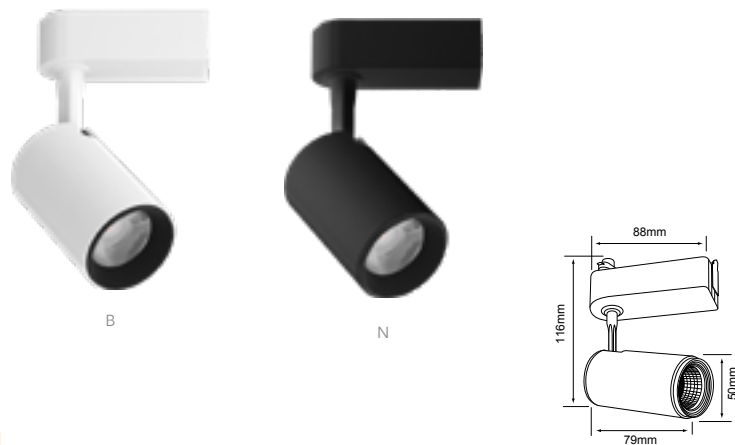

BEID I
7YSNLED005MV30B
Blanco

LUZ SUAVE CÁLIDA
● 3 000 K

Lumens: **440 lm**
Potencia: 7 W
Volts: 100-240 V ~

7YSNLED005MV30N
Negro

IRC: 80
Vida útil: **30 000 h**
Ángulo: 30 °
Tipo de lámpara: LED (Integrado)
Atenuable: No
Giratorio / Dirigible

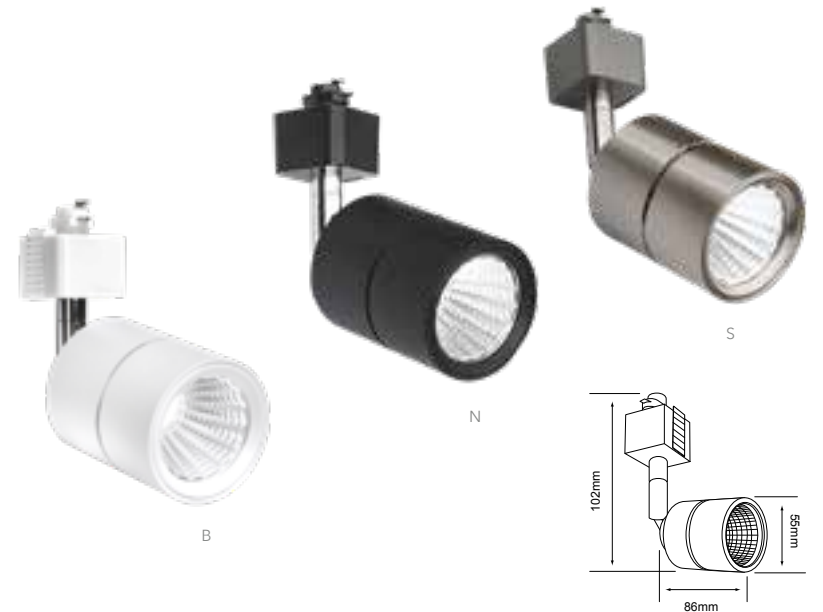

BOYERO
YSNLED-367/B
Blanco

LUZ SUAVE CÁLIDA
● 3 000 K

Lumens: **800 lm**
Potencia: 12 W
Volts: 100-240 V ~

YSNLED-367/N
Negro

IRC: 80
Vida útil: **15 000 h**
Ángulo: 24 °
Tipo de lámpara: LED (Integrado)
Atenuable: No
Dirigible

YSNLED-367/S
Satin



BASE AR111

AVOIR
60YS390MVB
Blanco

60YS390MVN
Negro

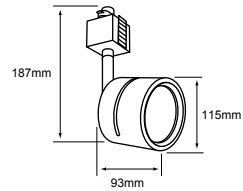

Potencia máx: 60 W
Volts: 100-240 V ~

Tipo de base: G53
Tipo de lámpara: AR111 (No incluida)
Dirigible

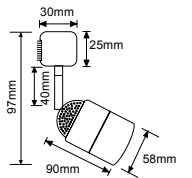

BELLAGIO I
YSN-367L/B
Blanco

YSN-367L/S
Satinado

YSN-367L/N
Negro

Potencia máx.: 50 W
Volts: 100-240 V ~ / 12 V ~

Tipo de base: GU10
Tipo de lámpara: GU10 (No incluida)
Dirigible

ACCESORIOS

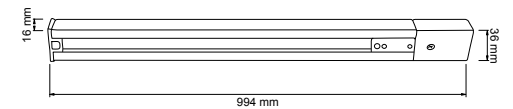

YS-100

YS-100/B: Blanco
YS-100/N: Negro
YS-100/S: Satinado

3 Hilos

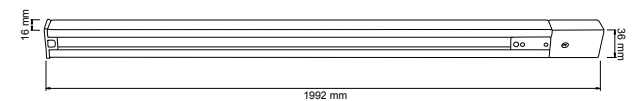

YS-200

YS-200/B: Blanco
YS-200/N: Negro
YS-200/S: Satinado

3 Hilos



BELFORT

YS-397/B YS-397/N
75YS397MVB 75YS397MVN
Blanco Negro

Potencia máx.: 75 W Tipo de base: E27
Volts: 100-240 V ~ Tipo de lámpara: PAR30 (No incluida)
Dirigible



BELLIZI

YS-395/B YS-395/N
90YS395MVB 90YS395MVN
Blanco Negro

Potencia máx.: 90 W Tipo de base: E27
Volts: 100-240 V ~ Tipo de lámpara: PAR38 (No incluida)
Dirigible



BREME

YS-399/B YS-399/N
90YS399MVB 90YD399MVN
Blanco Negro

Potencia máx.: 90 W Tipo de base: E27
Volts: 100-240 V ~ Tipo de lámpara: PAR38 (No incluida)
Dirigible

ACCESORIOS

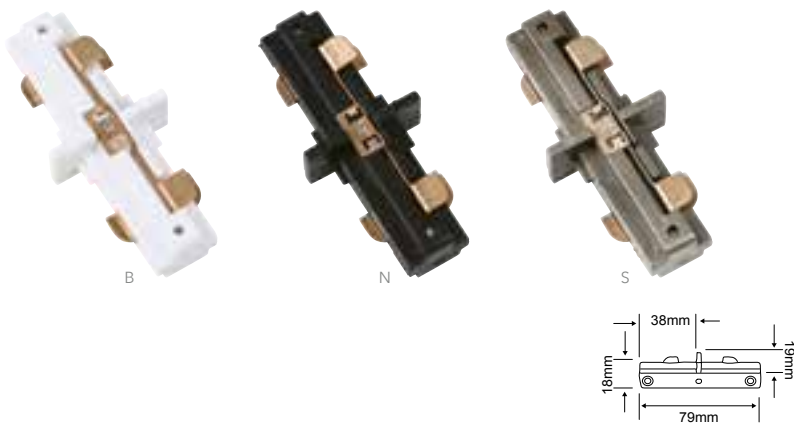

YS-I/B: Blanco 3 Hilos
YS-I/N: Negro
YS-I/S: Satinado

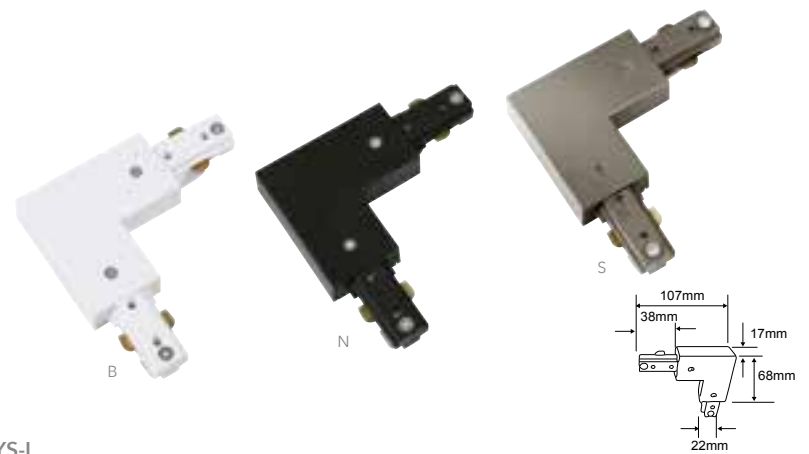

YS-L 3 Hilos
YS-L/B: Blanco
YS-L/N: Negro
YS-L/S: Satinado

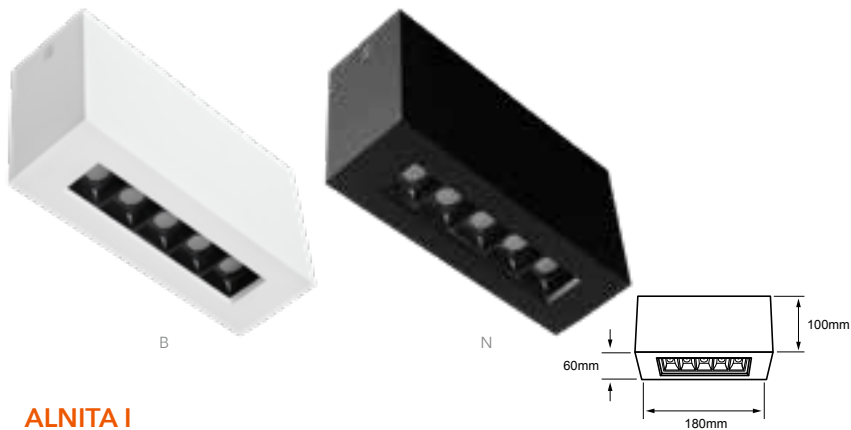

ALNITA I
8YSNLED3166MV30BN
Blanco / Negro

LUZ SUAVE CÁLIDA
● 3 000 K

Lumens: **668 lm**
Potencia: 8 W
Volts: 100-240 V ~

8YSNLED3166MV30N
Negro

IRC: 80
Vida útil: **25 000 h**
Ángulo: 24°
Tipo de lámpara: LED (integrado)
Incluye: Driver LED
Atenuable: No

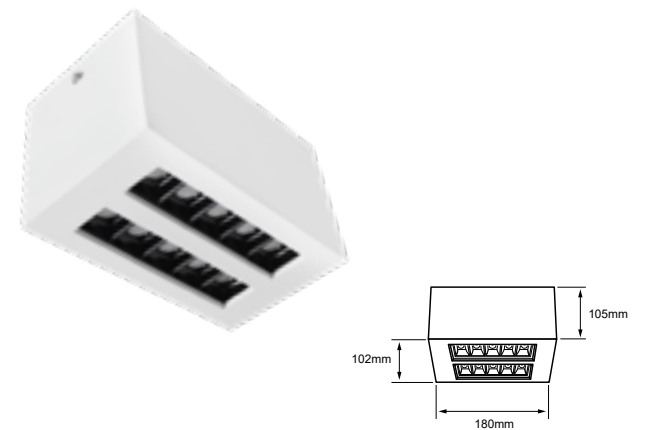

ALNITA II
16YSNLED3167MV30BN
Blanco

LUZ SUAVE CÁLIDA
● 3 000 K

Lumens: **1 378 lm**
Potencia: 16 W
Volts: 100-240 V ~

IRC: 80
Vida útil: **25 000 h**
Ángulo: 36°
Tipo de lámpara: LED (integrado)
Incluye: Driver LED
Atenuable: No



ASHLESHA
10YSNLED009MV30B
Blanco

LUZ SUAVE CÁLIDA
● 3 000 K

Lumens: **1 020 lm**
Potencia: 10 W
Volts: 100-240 V ~

10YSNLED009MV30N
Negro

IRC: 80
Vida útil: **30 000 h**
Ángulo: 36°
Tipo de lámpara: LED (integrado)
Atenuable: No

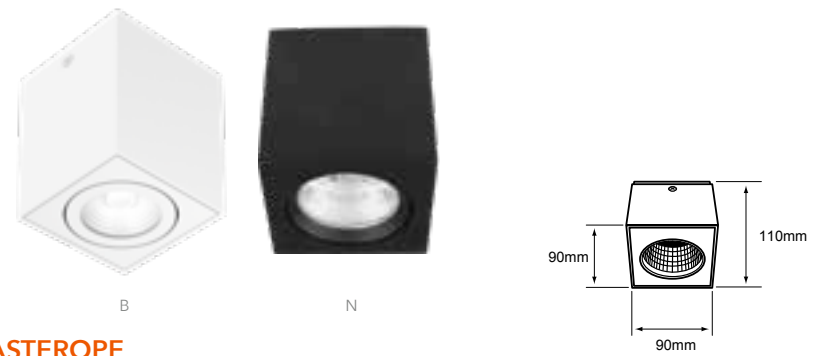

ASTEROPE
10YSNLED010MV30B
Blanco

LUZ SUAVE CÁLIDA
● 3 000 K

Lumens: **1 020 lm**
Potencia: 10 W
Volts: 100-240 V ~

10YSNLED010MV30N
Negro

IRC: 80
Vida útil: **30 000 h**
Ángulo: 36°
Tipo de lámpara: LED (integrado)
Atenuable: No



ASHLESHA I
20DYSNLED009V30B
Blanco

LUZ SUAVE CÁLIDA
● 3 000 K

Lumens: **1 850 lm**
Potencia: 20 W
Volts: 127 V ~

20DYSNLED009V30N
Negro

IRC: 80
Vida útil: **30 000 h**
Ángulo: 36°
Tipo de lámpara: LED (integrado)
Atenuable: Si

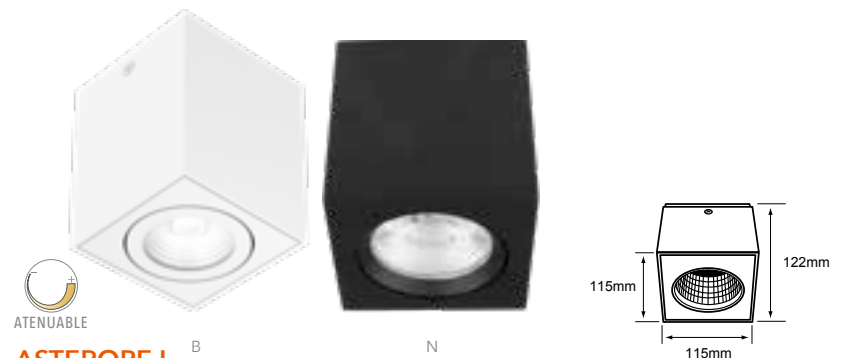

ASTEROPE I
20DYSNLED010V30B
Blanco

LUZ SUAVE CÁLIDA
● 3 000 K

Lumens: **1 850 lm**
Potencia: 20 W
Volts: 127 V ~

20DYSNLED010V30N
Negro

IRC: 80
Vida útil: **30 000 h**
Ángulo: 36°
Tipo de lámpara: LED (integrado)
Atenuable: Si



B

ALNIYA I
10YSNLED025MV30B
Blanco

LUZ SUAVE CÁLIDA
● 3 000 K

Lumens: **650 lm**
Potencia: **10 W**
Volts: **100-240 V ~**



N

10YSNLED025MV30N
Negro

IRC: **90**
Vida útil: **50 000 h**
Ángulo: **24°**
Tipo de lámpara: **LED (Integrado)**
Incluye: **Driver LED**
Atenuable: **No**

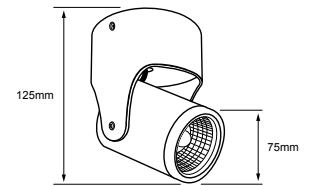

B

ALNIYA II
20YSNLED030MV30B
Blanco

LUZ SUAVE CÁLIDA
● 3 000 K

Lumens: **1 360 lm**
Potencia: **20 W**
Volts: **100-240 V ~**



N

20YSNLED030MV30N
Negro

IRC: **90**
Vida útil: **50 000 h**
Ángulo: **24°**
Tipo de lámpara: **LED (Integrado)**
Incluye: **Driver LED**
Atenuable: **No**

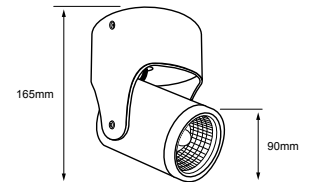

B

POLLUX
YSNLED-007/30/B
Blanco

LUZ SUAVE CÁLIDA
● 3 000 K

Lumens: **570 lm**
Potencia: **6.5 W**
Volts: **100-240 V ~**



N

YSNLED-007/30/N
Negro

IRC: **80**
Vida útil: **15 000 h**
Ángulo: **35°**
Tipo de lámpara: **LED (Integrado)**
Atenuable: **No**
Dirigible

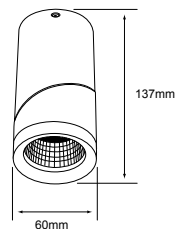

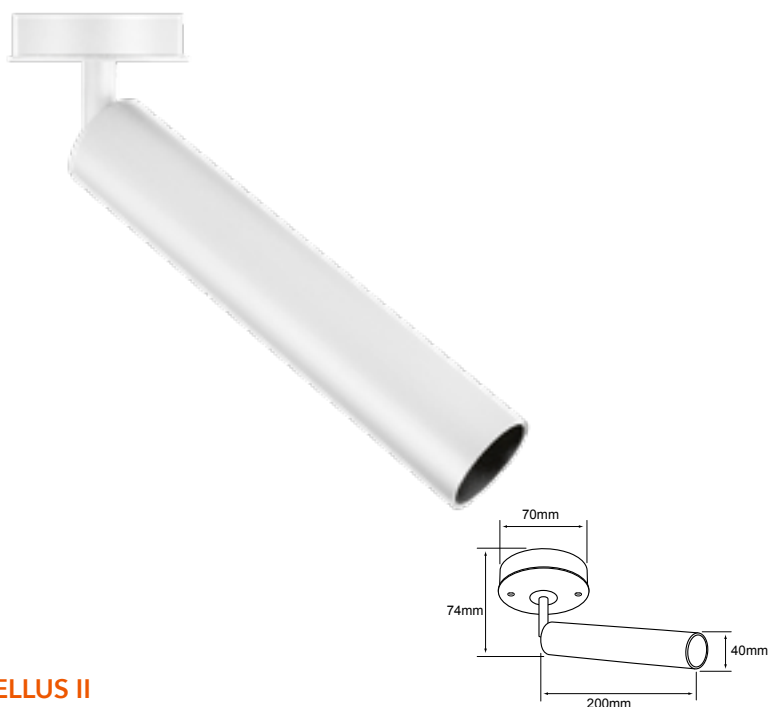

ASELLUS II
7LVCLED020MV30B

LUZ SUAVE CÁLIDA
● 3 000 K

Lumens: **250 lm**
Potencia: 7 W
Volts: 100-240 V ~

Terminado: **Blanco**
IRC: **90**
Vida útil: **30 000 h**
Ángulo: **24 °**
Tipo de lámpara: **LED (Integrado)**
Atenuable: **No**
Giratorio / Dirigible



PRAIA
PTLLED-209/24W/30/B
Blanco

LUZ SUAVE CÁLIDA
● 3 000 K

Lumens: **1 450 lm**
Potencia: 24 W
Volts: 100-240 V ~

24PTLLED209MV30N
Negro

IRC: **80**
Vida útil: **30 000 h**
Ángulo: **20°**
Tipo de lámpara: **LED (Integrado)**
Incluye: **Driver LED**
Atenuable: **No**
Dirigible



BEID II
7LVCLED005MV30B
Blanco

LUZ SUAVE CÁLIDA
● 3 000 K

Lumens: **440 lm**
Potencia: 7 W
Volts: 100-240 V ~

7LVCLED005MV30N
Negro

IRC: **80**
Vida útil: **30 000 h**
Ángulo: **30 °**
Tipo de lámpara: **LED (Integrado)**
Atenuable: **No**
Giratorio / Dirigible

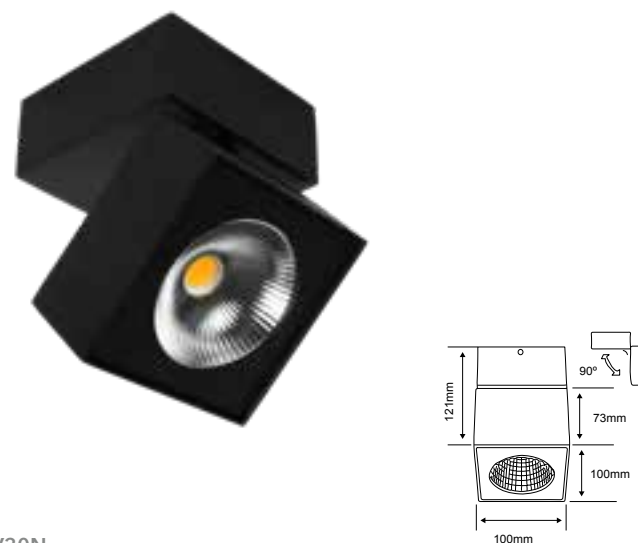

PING
13PTLLED210MV30N

LUZ SUAVE CÁLIDA
● 3 000 K

Lumens: **950 lm**
Potencia: 13 W
Volts: 100-240 V ~

Terminado: **Negro**
IRC: **80**
Vida útil: **30 000 h**
Ángulo: **20°**
Tipo de lámpara: **LED (Integrado)**
Incluye: **Driver LED**
Atenuable: **No**
Dirigible



HAN I
6LVCLED891MV30B
Blanco

LUZ SUAVE CÁLIDA
● 3 000 K

Lumens: **370 lm**
Potencia: **6 W**
Volts: 100-240 V ~



6LVCLED891MV30N
Negro

IRC: **80**
Vida útil: **15 000 h**
Ángulo: **40°**
Tipo de lámpara: LED (Integrado)
Atenuable: No
Giratorio / Dirigible

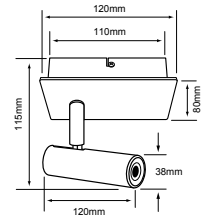

HAN II
18LVRLED893MV30B
Blanco

LUZ SUAVE CÁLIDA
● 3 000 K

Lumens: **1 520 lm**
Potencia: **18 W**
Volts: 100-240 V ~



18LVRLED893MV30N
Negro

IRC: **80**
Vida útil: **15 000 h**
Ángulo: **40°**
Tipo de lámpara: LED (Integrado)
Atenuable: No
Giratorio / Dirigible

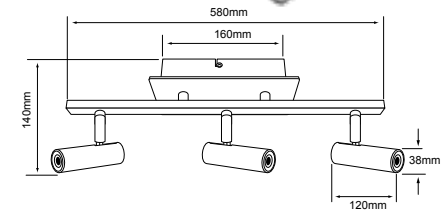

CAELUM
YSNLED-368/B
Blanco

LUZ SUAVE CÁLIDA
● 3 000 K

Lumens: **800 lm**
Potencia: **12 W**
Volts: 100-240 V ~



YSNLED-368/N
Negro



YSNLED-368/S
Satin

IRC: **80**
Vida útil: **15 000 h**
Ángulo: **24°**
Tipo de lámpara: LED (Integrado)
Atenuable: No
Dirigible

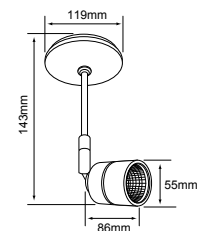



B



N



BASE AR111

AVOIR I
60YS391MVB
Blanco

Potencia máx.: 60 W
Volts: 100-240 V ~

60YS391MVN
Negro

Tipo de base: G53
Tipo de lámpara: AR111 (No incluida)
Dirigible

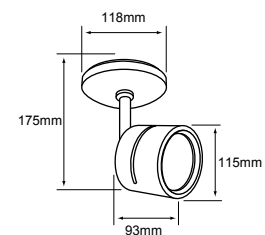

NUEVO
ALNASI I
60YSN4020MVB

Potencia máx.: 60 W
Volts: 100-240 V ~

Terminado: Blanco
Tipo de base: GX5.3
Tipo de lámpara: MR16 (No incluida)
IP: 20
Dirigible



NUEVO
ALNASI II
60YSN4010MVB

Potencia máx.: 60 W
Volts: 100-240 V ~

Terminado: Blanco
Tipo de base: GX5.3
Tipo de lámpara: MR16 (No incluida)
IP: 20
Dirigible

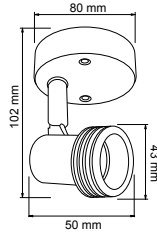

BITELLO
60LVC301MVS

Potencia máx.: 50 W
Volts: 100-240 V ~ / 12 V ~

Terminado: **Satinado**
Tipo de base: **GU10**
Tipo de lámpara: **GU10**
(No incluida) **Dirigible**

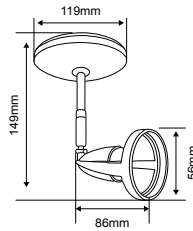

BAVENO
60YSN378LMVB
Blanco

Potencia máx.: 50 W
Volts: 100-240 V ~ / 12 V ~

60YSN378LMVS
Satinado

Tipo de base: **GU10**
Tipo de lámpara: **GU10** (No incluida)
Dirigible

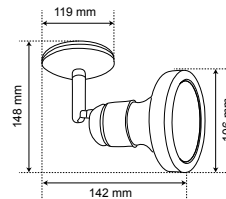

BELFORTI I
75YS398MVB
YS-398/B
Blanco

Potencia máx.: 75 W
Volts: 100-240 V ~

75YS398MVN
YS-398/N
Negro

Tipo de base: **E27**
Tipo de lámpara: **PAR30** (No incluida)
Dirigible

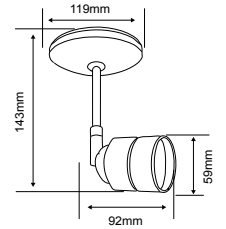

BELLAGIO
60YSN368LMVB
Blanco

Potencia máx.: 50 W
Volts: 100-240 V ~ / 12 V ~

60YSN368LMVN
Negro

60YSN368LMVS
Satinado

Tipo de base: **GU10**
Tipo de lámpara: **GU10** (No incluida)
Dirigible

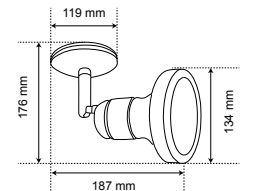

BREME I
90YS400MVB
YS-400/B
Blanco

Potencia máx.: 90 W
Volts: 100-240 V ~

90YS400MVN
YS-400/N
Negro

Tipo de base: **E27**
Tipo de lámpara: **PAR38** (No incluida)
Dirigible

Lámparas a 12 V requiere transformador.

*Tecnolite se reserva el derecho de modificar la información sin previo aviso y no se hace responsable por errores u omisiones en este documento.
*Lámparas y luminarios no aptos para trabajo de voltaje constante en niveles superiores o inferiores marcados en el producto.

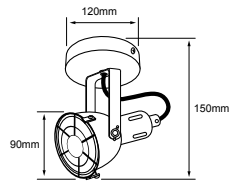

BRACHIUM I
60LVC401MVN

Potencia máx.: 60 W
Volts: 100-240 V ~

Terminado: Negro
Tipo de base: GU10
Tipo de lámpara: GU10 (No Incluida)
Dirigible

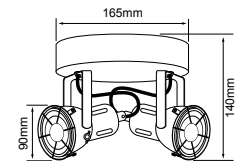

BRACHIUM II
120LVC402MVN

Potencia máx.: 120 W
Volts: 100-240 V ~

Terminado: Negro
Tipo de base: GU10 x 2
Tipo de lámpara: GU10 (No Incluida)
Dirigible

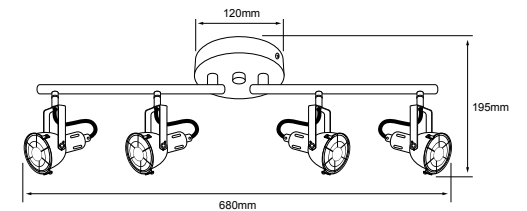

BRACHIUM III
240LVR404MVN

Potencia máx.: 240 W
Volts: 100-240 V ~

Terminado: Negro
Tipo de base: GU10 x 4

Tipo de lámpara: GU10 (No Incluida)
Dirigible

Lámparas a 12 V requiere transformador.

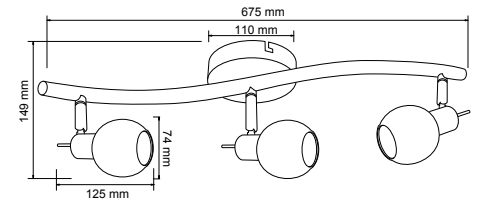

BALEN I
180LVR7403VS

Potencia máx.: 120 W
Volts: 100-240 V ~ / 12 V ~

Terminado: **Satinado**
Tipo de base: **G9 x 3**
Tipo de lámpara: **G9 x 3 (No incluida)**
Dirigible

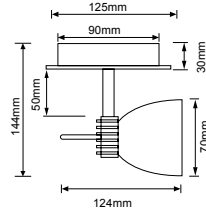

BRASSA
60LVC801VS

Potencia máx.: 50 W
Volts: 100-240 V ~ / 12 V ~

Terminado: **Satinado**
Tipo de base: **GY6.35**
Tipo de lámpara: **JCD (No incluida)**
Dirigible

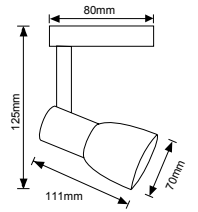

BRENO
60LVC1001VS

Potencia máx.: 40 W
Volts: 100-240 V ~

Terminado: **Satinado**
Tipo de base: **G9**
Tipo de lámpara: **G9 (No incluida)**
Dirigible

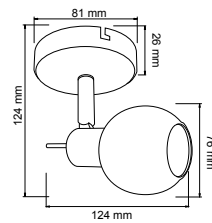

BALEN
60LVC7401VS

Potencia máx.: 40 W
Volts: 100-240 V ~ / 12 V ~

Terminado: **Satinado**
Tipo de base: **G9**
Tipo de lámpara: **G9 (No incluida)**
Dirigible

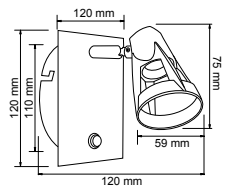

CARIATI
60LVC101MVS

Potencia máx.: 50 W
Volts: 100-240 V ~ / 12 V ~

Terminado: **Satinado**
Tipo de base: **GU10**
Tipo de lámpara: **GU10 (No incluida)**
Dirigible
Incluye apagador

Lámparas a 12 V requiere transformador.

*Tecnolite se reserva el derecho de modificar la información sin previo aviso y no se hace responsable por errores u omisiones en este documento.
*Lámparas y luminarios no aptos para trabajo de voltaje constante en niveles superiores o inferiores marcados en el producto.

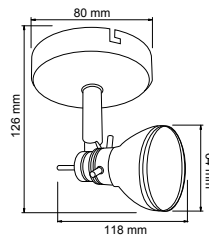

BARCELO
60LVC901MVS

Potencia máx.: 50 W
Volts: 100-240 V ~ / 12 V ~

Terminado: **Satinado**
Tipo de base: **GU10**
Tipo de lámpara: **GU10 (No incluida)**
Dirigible

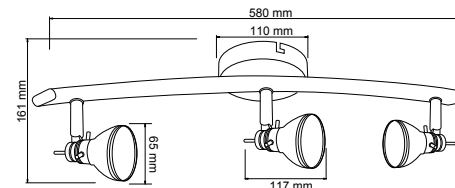

BARCELO I
180LVR903MVS

Potencia máx.: 150 W
Volts: 100-240 V ~ / 12 V ~

Terminado: **Satinado**
Tipo de base: **GU10 x 3**
Tipo de lámpara: **GU10 x 3 (No incluida)**
Dirigible

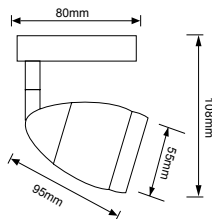

BEJAR
60LVC201MVS

Potencia máx.: 50 W
Volts: 100-240 V ~ / 12 V ~

Terminado: **Satinado**
Tipo de base: **GU10**
Tipo de lámpara: **GU10 (No incluida)**
Dirigible

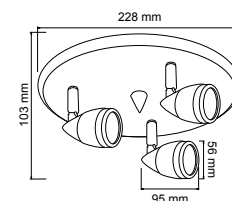

BEJAR I
180LVC203MVS

Potencia máx.: 150 W
Volts: 100-240 V ~ / 12 V ~

Terminado: **Satinado**
Tipo de base: **GU10 x 3**
Tipo de lámpara: **GU10 x 3 (No incluida)**
Dirigible

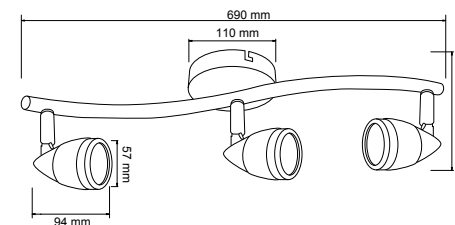

BEJAR II
180LVR203MVS

Potencia máx.: 150 W
Volts: 100-240 V ~ / 12 V ~

Terminado: **Satinado**
Tipo de base: **GU10 x 3**
Tipo de lámpara: **GU10 x 3 (No incluida)**
Dirigible

Lámparas a 12 V requiere transformador.

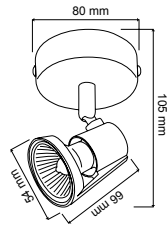

BRUSELAS
60LVC7201MVS

Potencia máx.: 50 W
Volts: 100-240 V ~ / 12 V ~

Terminado: **Satinado**
Tipo de base: **GU10**
Tipo de lámpara: **GU10 (No incluida)**
Dirigible

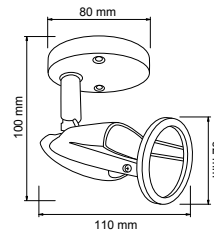

BOLOGNIA
60LVC601MVS

Potencia máx.: 50 W
Volts: 100-240 V ~ / 12 V ~

Terminado: **Satinado**
Tipo de base: **GU10**
Tipo de lámpara: **GU10 (No incluida)**
Dirigible

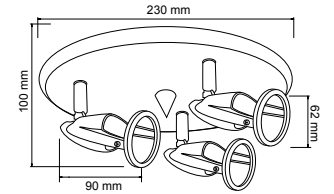

BOLOGNIA I
180LVC603MVS

Potencia máx.: 150 W
Volts: 100-240 V ~ / 12 V ~

Terminado: **Satinado**
Tipo de base: **GU10 x 3**
Tipo de lámpara: **GU10 x 3 (No incluida)**
Dirigible

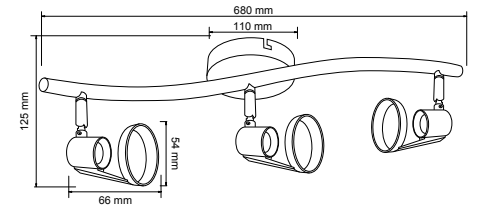

BRUSELAS I
180LVR7203MVS

Potencia máx.: 150 W
Volts: 100-240 V ~ / 12 V ~

Terminado: **Satinado**
Tipo de base: **GU10 x 3**
Tipo de lámpara: **GU10 x 3 (No incluida)**
Dirigible

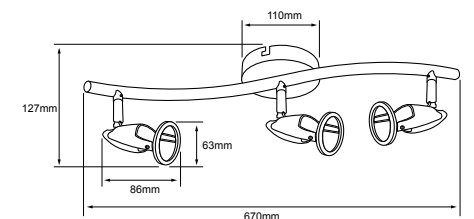

BOLOGNIA II
180LVR603MVS

Potencia máx.: 150 W
Volts: 100-240 V ~ / 12 V ~

Terminado: **Satinado**
Tipo de base: **GU10 x 3**
Tipo de lámpara: **GU10 x 3 (No incluida)**
Dirigible

Lámparas a 12 V requiere transformador.

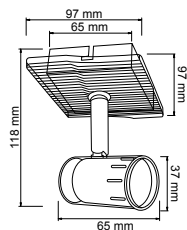

CASTEL
LVC-2201/S
60LVC2201MVS

Potencia máx.: 50 W
Volts: 100-240 V ~ / 12 V ~

Terminado: Satinado
Tipo de base: GU10
Tipo de lámpara: GU10 (No incluida)
Dirigible

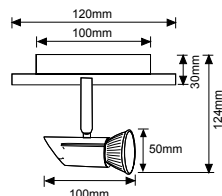

CAMPI
60LVC2401MVS

Potencia máx.: 50 W
Volts: 100-240 V ~ / 12 V ~

Terminado: Satinado
Tipo de base: GU10
Tipo de lámpara: GU10 (No incluida)
Dirigible

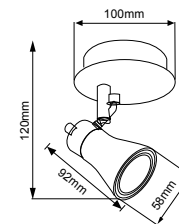

CASSANO
60LVC2801MVS

Potencia máx.: 50 W
Volts: 100-240 V ~ / 12 V ~

Terminado: Satinado
Tipo de base: GU10
Tipo de lámpara: GU10 (No incluida)
Dirigible

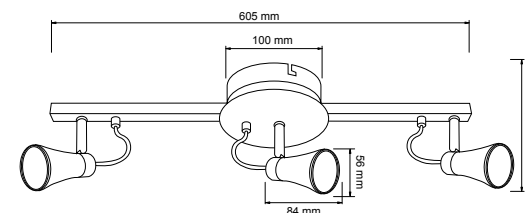

CASSANO I
180LVR2803MVS

Potencia máx.: 150 W
Volts: 100-240 V ~

Terminado: Satinado
Tipo de base: GU10 x 3
Tipo de lámpara: GU10 x 3 (No incluida)
Dirigible

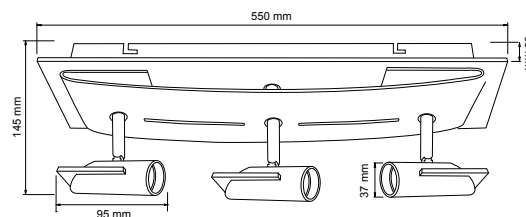

CAMENARO I
LVC-2003/S
180LVC2003MVS

Potencia máx.: 150 W
Volts: 100-240 V ~

Terminado: Satinado
Tipo de base: GU10 x 3
Tipo de lámpara: GU10 x 3 (No incluida)
Dirigible

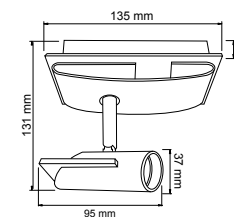

CAMENARO
60LVC2001MVS

Potencia máx.: 50 W
Volts: 100-240 V ~ / 12 V ~

Terminado: Satinado
Tipo de base: GU10
Tipo de lámpara: GU10 (No incluida)
Dirigible

Lámparas a 12 V requiere transformador.

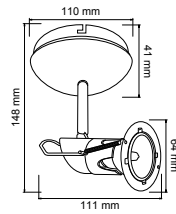

BOSCA
60LVC701MVS

Potencia máx.: 50 W
Volts: 100-240 V ~ / 12 V ~

Terminado: Satinado
Tipo de base: GU10
Tipo de lámpara: GU10 (No incluida)
Dirigible

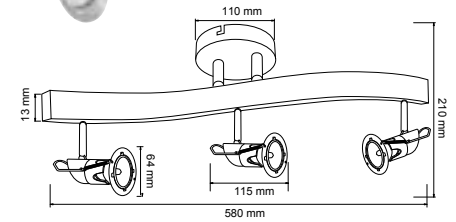

BOSCA II
180LVR703MVS

Potencia máx.: 150 W
Volts: 100-240 V ~ / 12 V ~

Terminado: Satinado
Tipo de base: GU10 x 3
Tipo de lámpara: GU10 x 3 (No incluida)
Dirigible

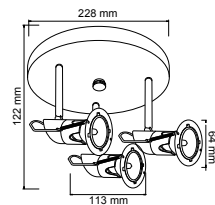

BOSCA I
LVC-703/S
180LVC703MVS

Potencia máx.: 150 W
Volts: 100-240 V ~ / 12 V ~

Terminado: Satinado
Tipo de base: GU10 x 3
Tipo de lámpara: GU10 x 3 (No incluida)
Dirigible

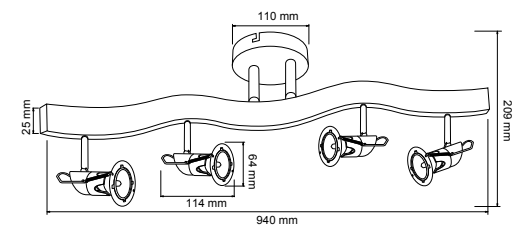

BOSCAR III
240LVR704MVS

Potencia máx.: 200 W
Volts: 100-240 V ~ / 12 V ~

Terminado: Satinado
Tipo de base: GU10 x 4
Tipo de lámpara: GU10 x 4 (No incluida)
Dirigible

Lámparas a 12 V requiere transformador.

The background of the advertisement is a photograph of an interior space. A large window on the right side shows a view of trees at night, with some lights visible in the distance. The room is dimly lit, with a warm glow from an interior light source. In the foreground, there are some white chairs and a dark table, partially visible. A large orange-red semi-transparent banner covers the middle section of the image, containing the main text.

INTERIOR DECORATIVA

TRANSFORMA TUS MOMENTOS
CON DETALLES DE ILUMINACIÓN

tecnolite®
LA LUZ ES TUYA





AGUJERO DE GUSANO

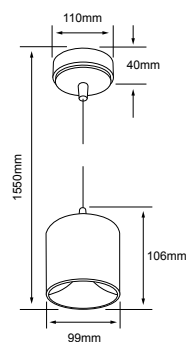

ATENUABLE

ALUDRA
12DCTLLED700V30N

LUZ SUAVE CÁLIDA
● 3 000 K

Lumens: **600 lm**
Potencia: **12 W**
Volts: **127 V ~**

Terminado: **Negro**
IRC: **80**
Vida útil: **15 000 h**
Ángulo: **110 °**
Tipo de lámpara: **LED (Integrado)**
Atenuable: **Si**

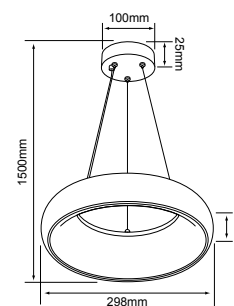

SATELITE
CTLLED-005/30/N

LUZ SUAVE CÁLIDA
● 3 000 K

Lumens: **1 800 lm**
Potencia: **25 W**
Volts: **100-240 V ~**

Terminado: **Negro**
IRC: **80**
Vida útil: **40 000 h**
Ángulo: **120 °**
Tipo de lámpara: **LED (Integrado)**
Atenuable: **No**

Línea Elite

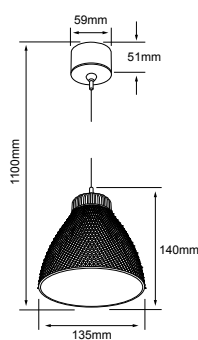

CURSA
5CTLLED8203MV30CT

LUZ SUAVE CÁLIDA
● 3 000 K

Lumens: **350 lm**
Potencia: **5 W**
Volts: **100-240 V ~**

Terminado: **Cristal Cortado**
IRC: **80**
Vida útil: **30 000 h**
Ángulo: **120 °**
Tipo de lámpara: **LED (Integrado)**
Atenuable: **No**
Miniatura

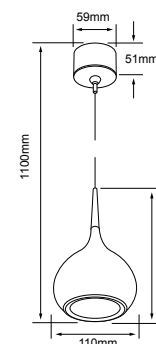

CANIS
5CTLLED102MV30CT

LUZ SUAVE CÁLIDA
● 3 000 K

Lumens: **350 lm**
Potencia: **5 W**
Volts: **100-240 V ~**

Terminado: **Cristal Transparente**
IRC: **80**
Vida útil: **30 000 h**
Ángulo: **120 °**
Tipo de lámpara: **LED (Integrado)**
Atenuable: **No**
Miniatura



EPSILON
CTLLED-152/30/B
Blanco

LUZ SUAVE CÁLIDA
● 3 000 K

Lumens: **210 lm**
Potencia: **3 W**
Volts: **100-240 V ~**

CTLLED-152/30/N
Negro

IRC: **80**
Vida útil: **15 000 h**
Ángulo: **10 °**
Tipo de lámpara: **LED (Integrado)**
Atenuable: **No**

EPSILON II
3CTLLED153MV30B

LUZ SUAVE CÁLIDA
● 3 000 K

Lumens: **117 lm**
Potencia: **3 W**
Volts: **100-240 V ~**

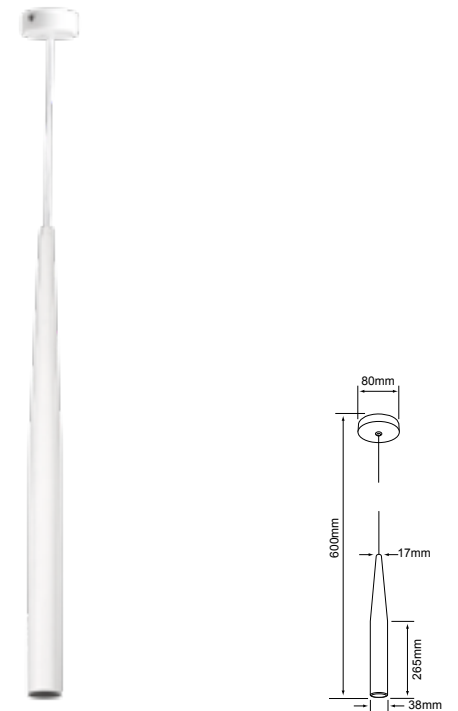

Terminado: **Blanco**
IRC: **80**
Vida útil: **15 000 h**
Ángulo: **18 °**
Tipo de lámpara: **LED (Integrado)**
Atenuable: **No**

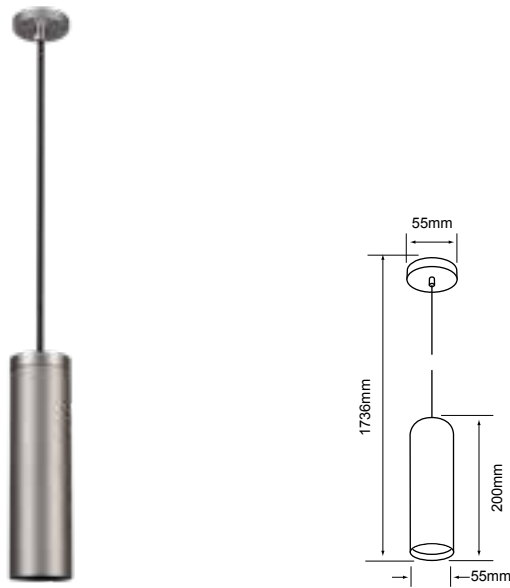

AZHA I
7CTLLED154MV30G

LUZ SUAVE CÁLIDA
● 3 000 K

Lumens: **370 lm**
Potencia: **7 W**
Volts: **100-240 V ~**

Terminado: **Gris**
IRC: **90**
Vida útil: **30 000 h**
Ángulo: **24 °**
Tipo de lámpara: **LED (Integrado)**
Atenuable: **No**

AZHA II
7CTLLED155MV30G

LUZ SUAVE CÁLIDA
● 3 000 K

Lumens: **250 lm**
Potencia: **7 W**
Volts: **100-240 V ~**

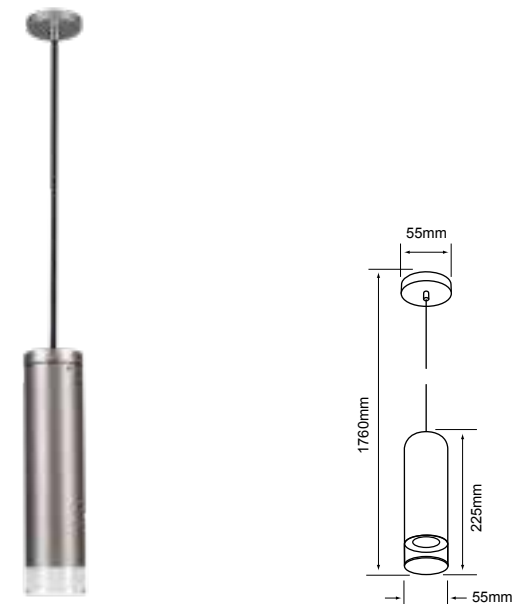

Terminado: **Gris**
IRC: **90**
Vida útil: **30 000 h**
Ángulo: **24 °**
Tipo de lámpara: **LED (Integrado)**
Atenuable: **No**

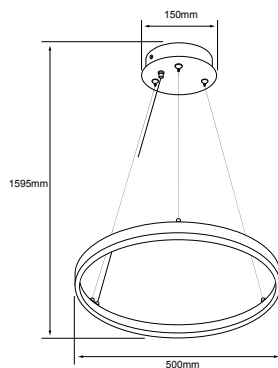

ATENUABLE

KAITOS
32DCTLLED205V30S

LUZ SUAVE CÁLIDA
● 3 000 K

Lumens: **2 916 lm**
Potencia: **32 W**
Volts: **127 V ~**

Terminado: **Satin**
Vida útil: **30 000 h**
Ángulo: **120°**
Tipo de lámpara: **LED (Integrado)**
Atenuable: **Si**

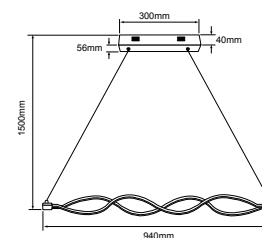

VELORUM
CTLLED-161/30/S

LUZ SUAVE CÁLIDA
● 3 000 K

Lumens: **1 340 lm**
Potencia: **22 W**
Volts: **100-240 V ~**

Terminado: **Satin**
IRC: **80**
Vida útil: **25 000 h**
Ángulo: **100°**
Tipo de lámpara: **LED (Integrado)**
Atenuable: **No**

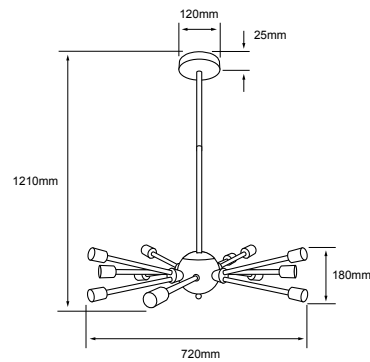

CELAENO I
720CTL8192MVN

Potencia máx.: 720 W
Volts: 100-240 V ~

Terminado: Negro
Tipo de base: E27
Tipo de lámpara: Opcional (No incluidas)

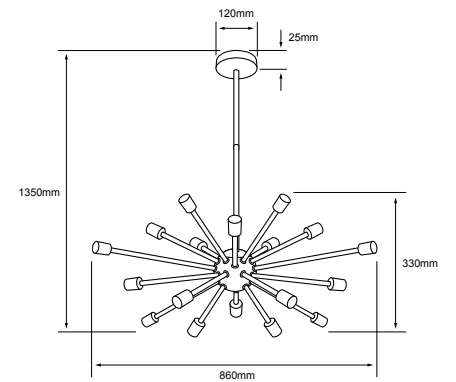

CELAENO II
1080CTL8192MVN

Potencia máx.: 1 080 W
Volts: 100-240 V ~

Terminado: Negro
Tipo de base: E27
Tipo de lámpara: Opcional (No incluidas)

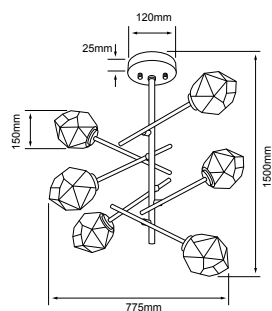

CASTULA I
36OCTL8616MVCT

Potencia máx.: 360 W
Volts: 100-240 V ~

Terminado: Negro
Tipo de base: E14 x 6
Tipo de lámpara: Opcional (No incluida)

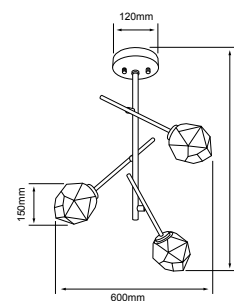

CASTULA II
180CTL8613MVCT

Potencia máx.: 180 W
Volts: 100-240 V ~

Terminado: Negro
Tipo de base: E14 x 3
Tipo de lámpara: Opcional (No incluida)

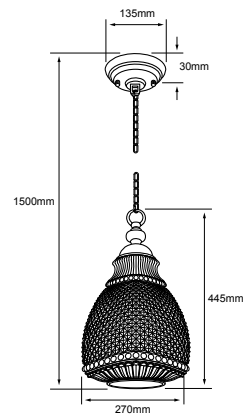

CHARA
60CTL8205MVCT

Potencia máx: 60 W
Volts: 100-240 V ~

Terminado: Negro
Tipo de base: E27
Tipo de lámpara: Opcional (No incluida)

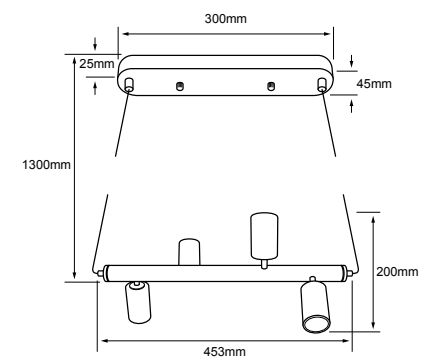

NUEVO
KANG
240CTL8430MVN

Potencia máx: 240 W
Volts: 100-240 V ~

Terminado: Negro
Tipo de base: E27 x 4
Tipo de lámpara: Opcional (No incluida)

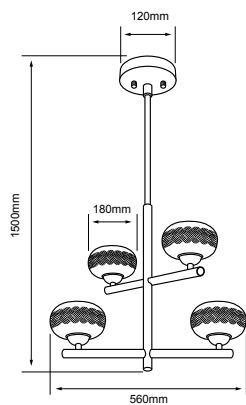

DIADEM II
240CTL8414MVCT

Potencia máx.: 240 W
Volts: 100-240 V ~

Terminado: Negro
Tipo de base: E27 x 4
Tipo de lámpara: Opcional (No incluida)

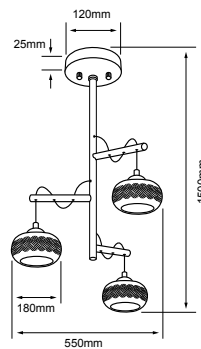

DIADEM III
180CTL8403MVCT

Potencia máx.: 180 W
Volts: 100-240 V ~

Terminado: Negro
Tipo de base: E27 x 3
Tipo de lámpara: Opcional (No incluida)

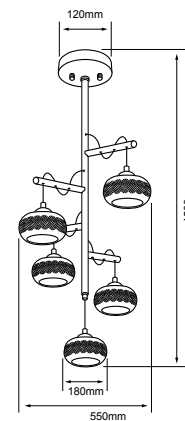

DIADEM IV
300CTL8405MVCT

Potencia máx.: 300 W
Volts: 100-240 V ~

Terminado: Negro
Tipo de base: E27 x 5
Tipo de lámpara: Opcional (No incluida)

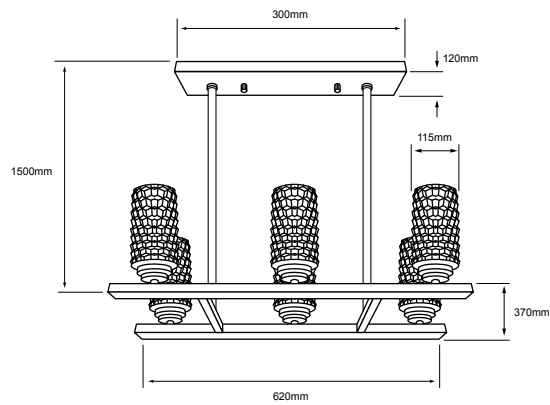

BERENICES IV
360CTL8516MVCT

Potencia máx.: 360 W
Volts: 100-240 V ~

Terminado: Negro
Tipo de base: E27 x 6
Tipo de lámpara: Opcional (No incluida)

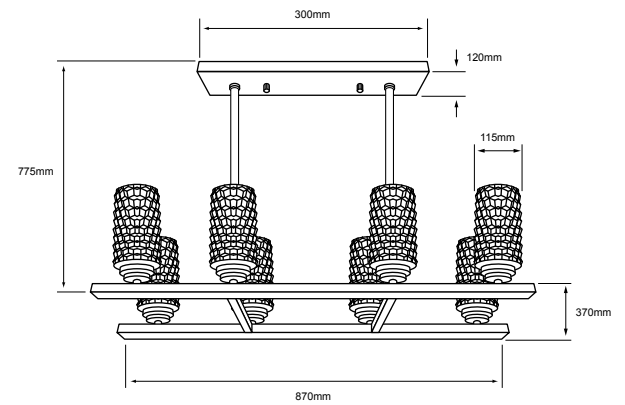

BERENICES V
480CTL8518MVCT

Potencia máx.: 480 W
Volts: 100-240 V ~

Terminado: Negro
Tipo de base: E27 x 8
Tipo de lámpara: Opcional (No incluida)

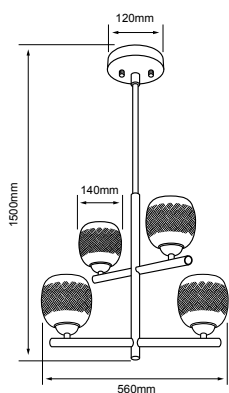

FULU I
240CTL8314MVCT

Potencia máx.: 240 W
Volts: 100-240 V ~

Terminado: Negro
Tipo de base: E27 x 4
Tipo de lámpara: Opcional (No incluida)

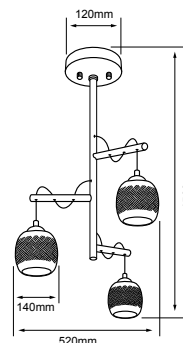

FULU II
180CTL8303MVCT

Potencia máx.: 180 W
Volts: 100-240 V ~

Terminado: Negro
Tipo de base: E27 x 3
Tipo de lámpara: Opcional (No incluida)

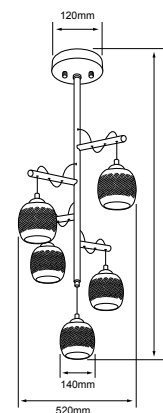

FULU III
300CTL8305MVCT

Potencia máx.: 300 W
Volts: 100-240 V ~

Terminado: Negro
Tipo de base: E27 x 5
Tipo de lámpara: Opcional (No incluida)

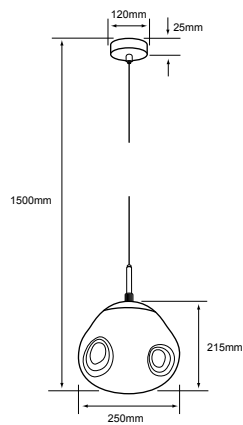

SAIPH
20CTL8194MVCO

Potencia máx.: 60 W
Volts: 100-240 V ~

Terminado: Cristal Cobre
Tipo de base: E27
Tipo de lámpara: Opcional (No incluida)

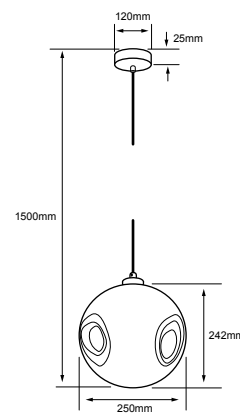

SALM
20CTL8195MVCR

Potencia máx.: 60 W
Volts: 100-240 V ~

Terminado: Cristal Cromo
Tipo de base: E27
Tipo de lámpara: Opcional (No incluida)

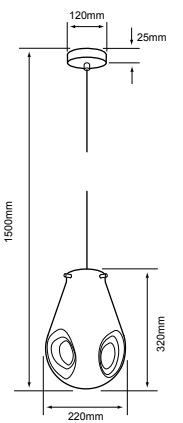

SARIN
20CTL8196MVCO
Cristal Cobre

Potencia máx.: 60 W
Volts: 100-240 V ~

Tipo de base: E27
Tipo de lámpara: Opcional (No incluida)



CR

CO

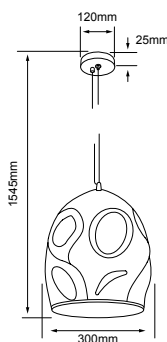

CR

CO

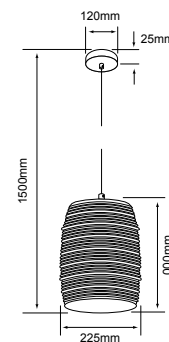
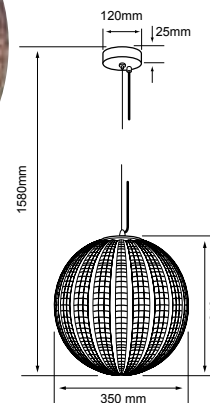

PROBUS

20CTL8197MVCO
Cristal Cobre

20CTL8197MVCR
Cristal Cromo

Potencia máx.: 60 W
Volts: 100-240 V ~

Tipo de base: E27
Tipo de lámpara: Opcional (No incluida)

PROCION

20CTL8065MVCO
Cristal Cobre

20CTL8065MVCR
Cristal Cromo

Potencia máx.: 60 W
Volts: 100-240 V ~

Tipo de base: E27
Tipo de lámpara: Opcional (No incluida)

UNUK

20CTL8189MVCO

Potencia máx.: 60 W
Volts: 100-240 V ~

Terminado: Cristal Cobre
Tipo de base: E27
Tipo de lámpara: Opcional (No incluida)

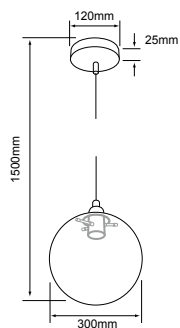

ARIETTIS
20CTL8184MVCH

Potencia máx.: 60 W
Volts: 100-240 V ~

Terminado: Cristal Humo
Tipo de base: E27
Tipo de lámpara: Opcional
(No incluida)

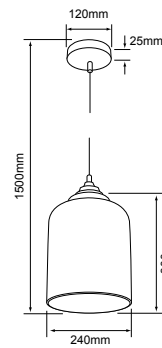

APODIS
20CTL8183MVCH

Potencia máx.: 60 W
Volts: 100-240 V ~

Terminado: Cristal Humo
Tipo de base: E27
Tipo de lámpara: Opcional
(No incluida)

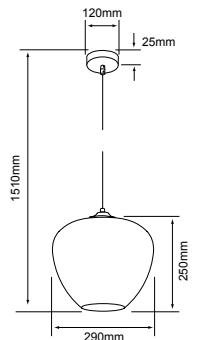

PRINCEPS
20CTL8188MVCH

Potencia máx.: 60 W
Volts: 100-240 V ~

Terminado: Cristal Humo
Tipo de base: E27
Tipo de lámpara: Opcional (No incluida)

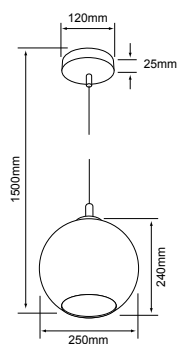

SELENE II
20CTL7422MVC3D

Potencia máx.: 60 W
Volts: 100-240 V ~

Terminado: Cristal 3D
Tipo de base: E27
Tipo de lámpara: Opcional (No incluida)

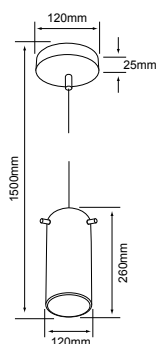

EROS
60CTL1702MV3D

Potencia máx.: 60 W
Volts: 100-240 V ~

Terminado: Cristal 3D
Tipo de base: E27
Tipo de lámpara: Opcional (No incluida)

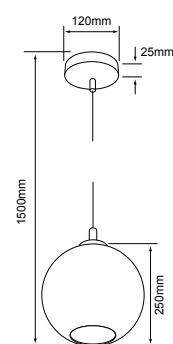

SELENE
60CTL7421MV3D

Potencia máx.: 60 W
Volts: 100-240 V ~

Terminado: Cristal 3D
Tipo de base: E27
Tipo de lámpara: Opcional (No incluida)

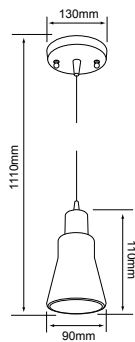

LVIV
20CTL3301MVNI

Potencia máx.: 60 W
Volts: 100-240 V ~

Terminado: Niquelado
Tipo de base: E27
Tipo de lámpara: Opcional
(No incluida)

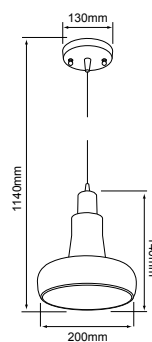

LVIV I
20CTL3302MVNI

Potencia máx.: 60 W
Volts: 100-240 V ~

Terminado: Niquelado
Tipo de base: E27
Tipo de lámpara: Opcional
(No incluida)

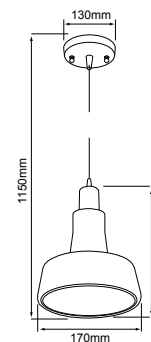

LVIV II
20CTL3303MVNI

Potencia máx.: 60 W
Volts: 100-240 V ~

Terminado: Niquelado
Tipo de base: E27
Tipo de lámpara: Opcional
(No incluida)

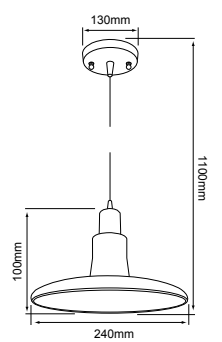
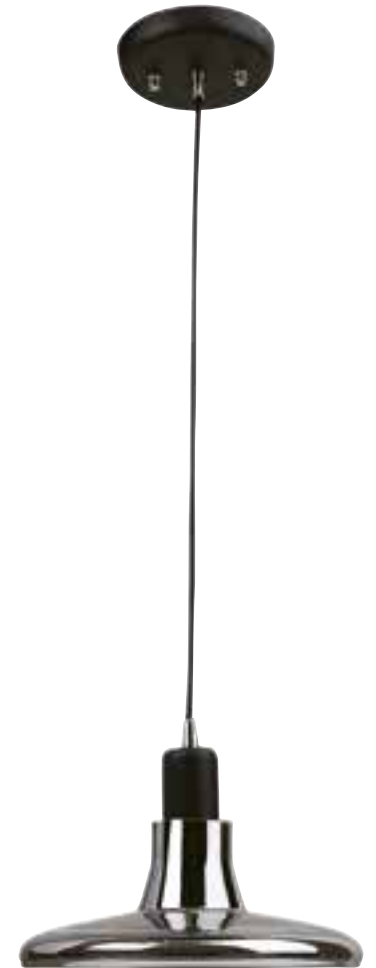

LVIV III
20CTL3304MVNI

Potencia máx.: 60 W
Volts: 100-240 V ~

Terminado: Niquelado
Tipo de base: E27
Tipo de lámpara: Opcional
(No incluida)

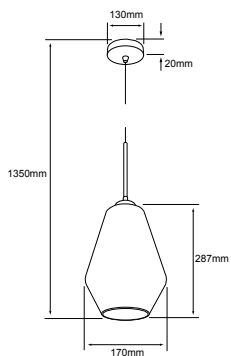

LILII
60CTL8199MVCA

Potencia máx.: 60 W Terminado: Cristal Ambar
Volts: 100-240 V ~ Tipo de base: E27
Tipo de lámpara: Opcional
(No incluida)

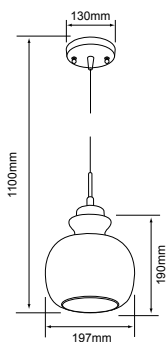

MINERVA
60CTL8173MVCA

Potencia máx.: 60 W Terminado: Cristal Ambar
Volts: 100-240 V ~ Tipo de base: E27
Tipo de lámpara: Opcional
(No incluida)

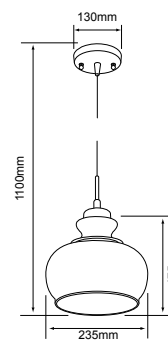

PERSEUS
60CTL8174MVCA

Potencia máx.: 60 W Terminado: Cristal Ambar
Volts: 100-240 V ~ Tipo de base: E27
Tipo de lámpara: Opcional
(No incluida)

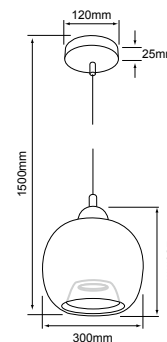

ATENEA
60CTL8172MVCA

Potencia máx.: 60 W Terminado: Cristal Ambar
Volts: 100-240 V ~ Tipo de base: E27
Tipo de lámpara: Opcional
(No incluida)

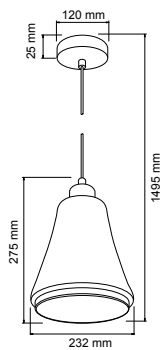

LAOS
60CTL8176MVC

Potencia máx.: 60 W
Volts: 100-240 V ~
Terminado: Cristal
Transparente
Tipo de base: E27
Tipo de lámpara: Opcional
(No incluida)

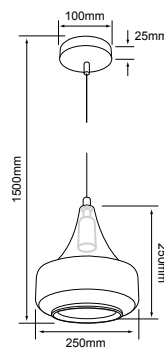

ARTEMISA
60CTL8177MVC

Potencia máx.: 60 W
Volts: 100-240 V ~
Terminado: Cristal
Tipo de base: E27
Tipo de lámpara: Opcional
(No incluida)

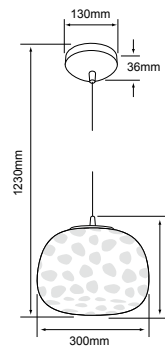
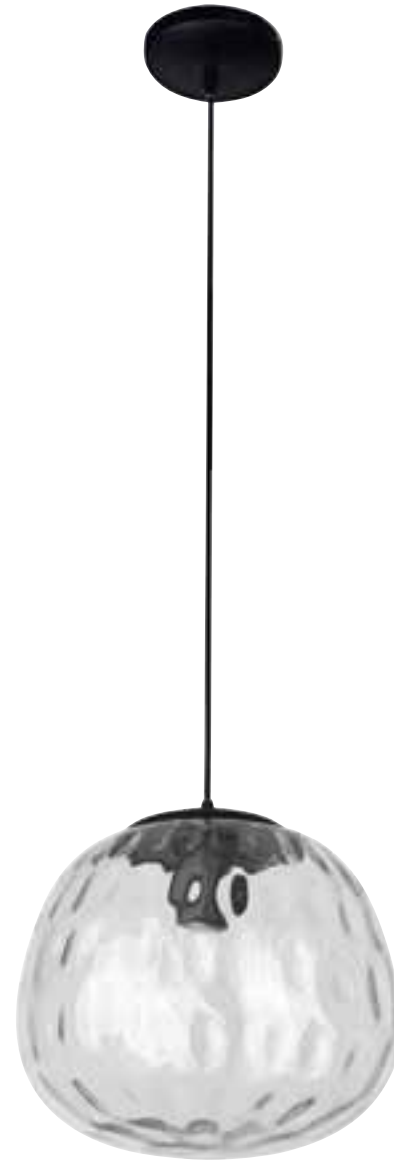

ALYA
CTL-8179/C

Potencia máx.: 60 W
Volts: 100-240 V ~
Terminado: Negro
Tipo de base: E27
Tipo de lámpara: Opcional
(No incluida)

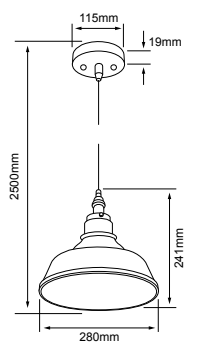

MAIA II
20CTL817MVCT

Potencia máx.: 60 W
Volts: 100-240 V ~
Terminado: Cristal
Transparente
Tipo de base: E27
Tipo de lámpara: Opcional
(No incluida)

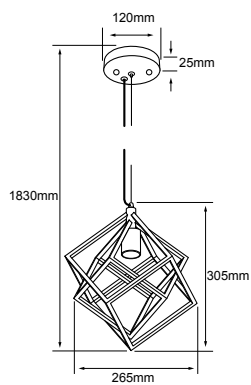

MERAK
60CTL6130MVN

Potencia máx.: 60 W
Volts: 100-240 V ~

Terminado: Negro
Tipo de base: E27
Tipo de lámpara:
Opcional (No incluida)

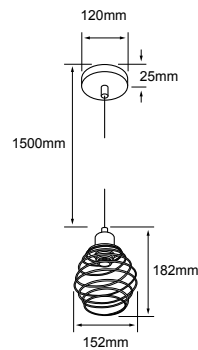

NUEVO
KITAL II
60CTL6127MVN

Potencia máx.: 60 W
Volts: 100-240 V ~

Terminado: Negro
Tipo de base: E27
Tipo de lámpara:
Opcional (No incluida)

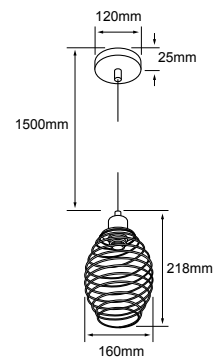

NUEVO
KITAL III
60CTL6128MVN

Potencia máx.: 60 W
Volts: 100-240 V ~

Terminado: Negro
Tipo de base: E27
Tipo de lámpara:
Opcional (No incluida)

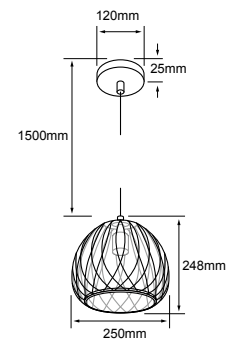

NUEVO
KOEIA II
60CTL6124MVN

Potencia máx.: 60 W
Volts: 100-240 V ~

Terminado: Negro / Cristal
Tipo de base: E27
Tipo de lámpara:
Opcional (No incluida)

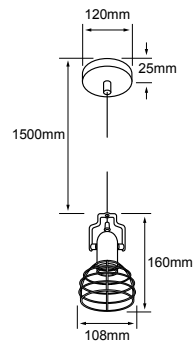

NUEVO
KOEIA I
60CTL6123MVBA

Potencia máx.: 60 W
Volts: 100-240 V ~

Terminado: Bronce / Negro
Tipo de base: E27
Tipo de lámpara: Opcional (No incluida)

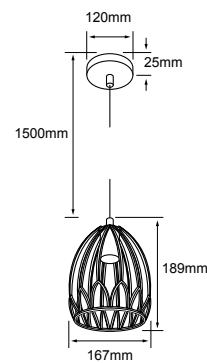

NUEVO
KITAL I
60CTL6126MVD

Potencia máx.: 60 W
Volts: 100-240 V ~

Terminado: Bronce suave
Tipo de base: E27
Tipo de lámpara: Opcional (No incluida)

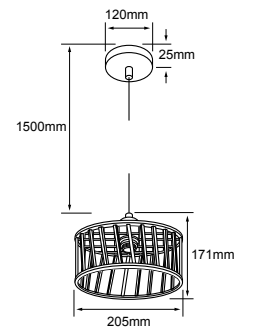

NUEVO
KOEIA III
60CTL6125MVD

Potencia máx.: 60 W
Volts: 100-240 V ~

Terminado: Bronce Suave
Tipo de base: E27
Tipo de lámpara: Opcional (No incluida)

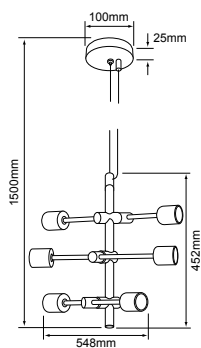

SESTUS
20CTL8190MVN

Potencia máx.: 360 W
Volts: 100-240 V ~

Terminado: Negro Mate
Tipo de base: E27
Tipo de lámpara: Opcional (No incluida)

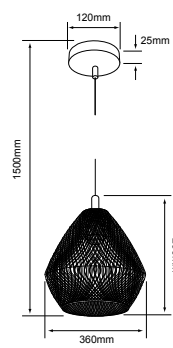

AFRODITA
60CTL6121MVCO

Potencia máx.: 60 W
Volts: 100-240 V ~

Terminado: Cobre
Tipo de base: E27
Tipo de lámpara: Opcional (No incluida)

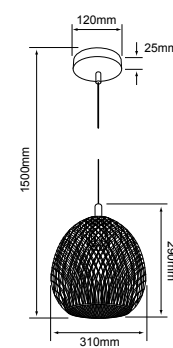

VENUS
60CTL6122MVCO

Potencia máx.: 60 W
Volts: 100-240 V ~

Terminado: Cobre
Tipo de base: E27
Tipo de lámpara: Opcional (No incluida)

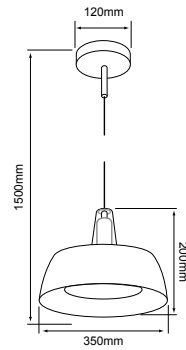

LA CANEE
60CTL320MVCO

Potencia máx.: 60 W
Volts: 100-240 V ~

Terminado: Cobre
Tipo de base: E27
Tipo de lámpara: Opcional (No incluida)

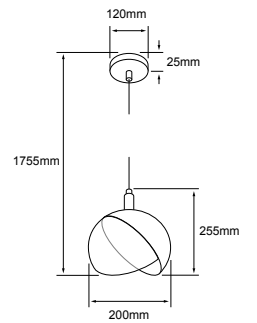

NUEVO
KORNE
60CTL818MVBA

Potencia máx.: 60 W
Volts: 100-240 V ~

Terminado: Bronce
Tipo de base: E27
Tipo de lámpara: Opcional (No incluida)



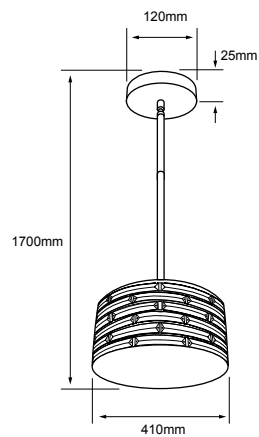

MIMOSA
60CTL7284MVC

Potencia máx.: 180 W
Volts: 100-240 V ~

Terminado: Cristal
Tipo de base: E27 x 3
Tipo de lámpara: Opcional (No incluida)
Cristal incrustado a mano

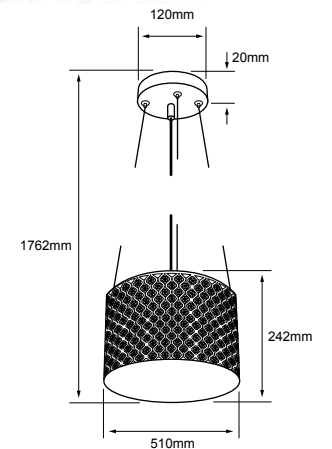

MINCHIR
60CTL7282MVS

Potencia máx.: 180 W
Volts: 100-240 V ~

Terminado: Satinado / Cristal
Tipo de base: E27 x 3
Tipo de lámpara: Opcional (No incluida)
Cristal incrustado a mano

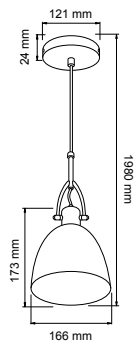

BAMBA
CTL-8210/CR

Potencia máx.: 60 W
Volts: 100-240 V ~

Terminado: Cromado
Tipo de base: E27
Tipo de lámpara: Opcional (No incluida)

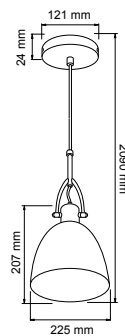

BAMBA I
CTL-8215/CR

Potencia máx.: 60 W
Volts: 100-240 V ~

Terminado: Cromado
Tipo de base: E27
Tipo de lámpara: Opcional (No incluida)

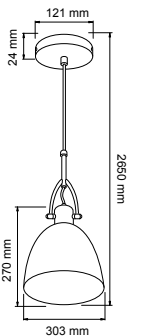

BAMBA II
CTL-8220/CR

Potencia máx.: 60 W
Volts: 100-240 V ~

Terminado: Cromado
Tipo de base: E27
Tipo de lámpara: Opcional (No incluida)



N

O

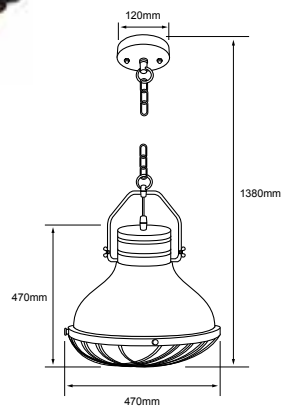

MISAM
60CTL1412MVN Negro

60CTL1412MVOX Oxido

Potencia máx.: 60 W
Volts: 100-240 V ~

Tipo de base: E27
Tipo de lámpara: Opcional (No incluida)



N

O

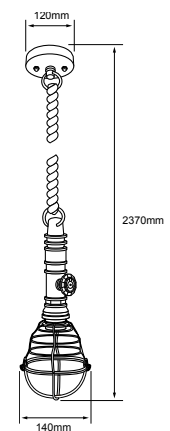

MUSCIDA
60CTL1414MVN Negro

60CTL1414MVOX Oxido

Potencia máx.: 60 W
Volts: 100-240 V ~

Tipo de base: E27
Tipo de lámpara: Opcional (No incluida)

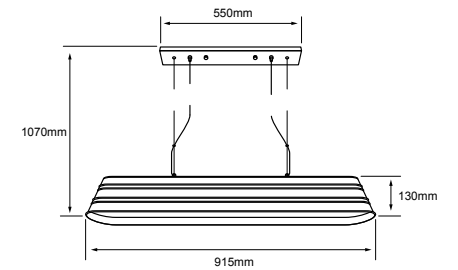

PIPIRIMA
240CTL1404MV

Potencia máx.: 240 W
Volts: 100-240 V ~

Terminado: Negro
Tipo de base: E27 x 4
Tipo de lámpara: Opcional (No incluida)

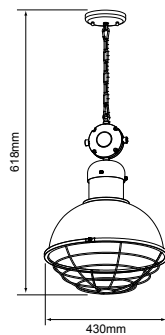

BESSEL
20CTL1410MVBA

Potencia máx.: 60 W
Volts: 100-240 V ~

Terminado: Bronce Antiguo
Tipo de base: E27
Tipo de lámpara: Opcional (No incluida)
Diseño industrial

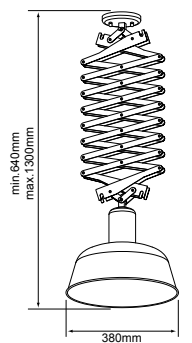

BENETNASCH
20CTL1400MVN

Potencia máx.: 60 W
Volts: 100-240 V ~

Terminado: Negro
Tipo de base: E27
Tipo de lámpara: Opcional (No incluida)
Diseño industrial

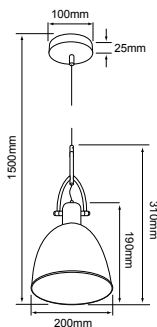

ELECTRA
60CTL8212MVPL

Potencia máx.: 60 W
Volts: 100-240 V ~

Terminado: Plata
Tipo de base: E27
Tipo de lámpara: Opcional (No incluida)
Diseño industrial

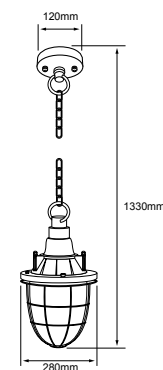

POLARIS
60CTL1418MVN

Potencia máx.: 60 W
Volts: 100-240 V ~

Terminado: Negro
Tipo de base: E27
Tipo de lámpara: Opcional (No incluida)





AT

AC

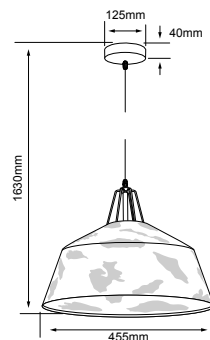

TIAN

20CTL1310MVAT
Acrílico Transparente

Potencia máx.: 60 W
Volts: 100-240 V ~

20CTL1310MVAC
Acrílico Café

Tipo de base: E27
Tipo de lámpara: Opcional (No incluida)

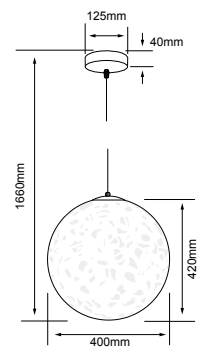

KEID

20CTL6030MVAC

Potencia máx.: 60 W
Volts: 100-240 V ~

Terminado: Acrílico Café
Tipo de base: E27
Tipo de lámpara: Opcional (No incluida)

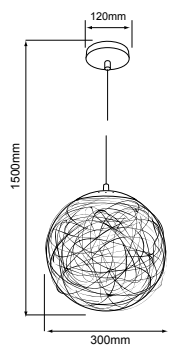

BASTIA
60CTL6021MVAL

Potencia máx.: 60 W
Volts: 100-240 V ~

Terminado: Aluminio
Tipo de base: E27
Tipo de lámpara: Opcional (No incluida)

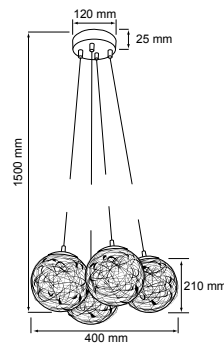
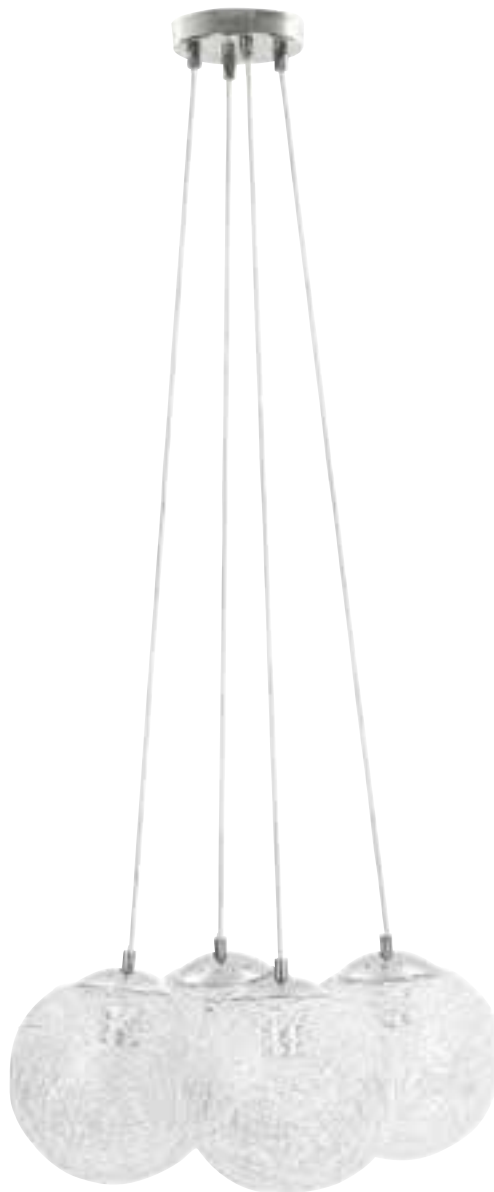

BASTIA I
CTL-6023

Potencia máx.: 60 W
Volts: 100-240 V ~

Terminado: Aluminio
Tipo de base: E27
Tipo de lámpara: Opcional (No incluida)

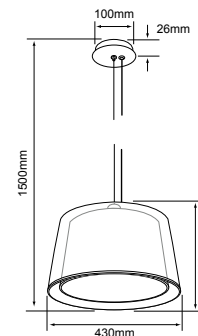

DENEb
20CTL7283MVN

Potencia máx.: 60 W
Volts: 100-240 V ~

Terminado: Textil Negro / Textil Blanco
Tipo de base: E27
Tipo de lámpara: Opcional (No incluida)

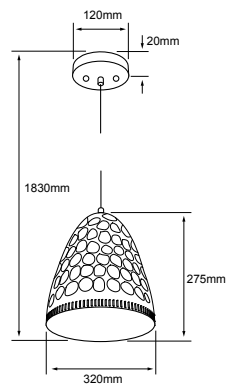

PRIMA
60CTL1949MVN

Potencia máx.: 60 W
Volts: 100-240 V ~

Terminado: Negro
Tipo de base: E27
Tipo de lámpara: Opcional (No incluida)

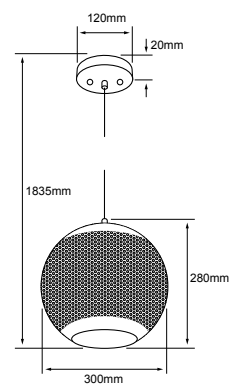

RIGIL
60CTL1945MVN

Potencia máx.: 60 W
Volts: 100-240 V ~

Terminado: Negro
Tipo de base: E27
Tipo de lámpara: Opcional (No incluida)



AJUSTABLE

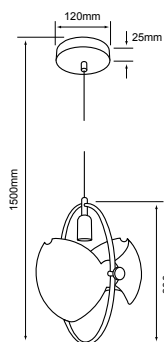

KENTAURUS
60CTL1948MVN

Potencia máx.: 60 W
Volts: 100-240 V ~

Terminado: Negro
Tipo de base: E27
Tipo de lámpara: Opcional
(No incluida)



INTERIOR
ORO

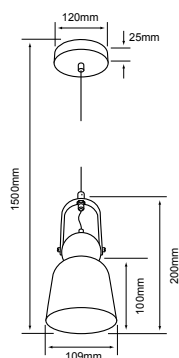

RAN I
60CTL8001MVN

Potencia máx.: 60 W
Volts: 100-240 V ~

Terminado: Negro
Tipo de base: E27
Tipo de lámpara: Opcional
(No incluida)



INTERIOR
ORO

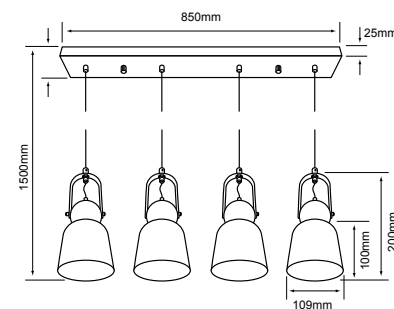

RAN II
240CTL8004MVN

Potencia máx.: 240 W
Volts: 100-240 V ~

Terminado: Negro
Tipo de base: E27 x 4
Tipo de lámpara: Opcional (No incluida)



INTERIOR
ORO

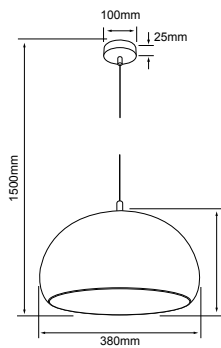

AGORA II
20CTL1941MVN

Potencia máx.: 60 W
Volts: 100-240 V ~

Terminado: Negro Mate /
Interior Dorado
Tipo de base: E27
Tipo de lámpara: Opcional
(No incluida)

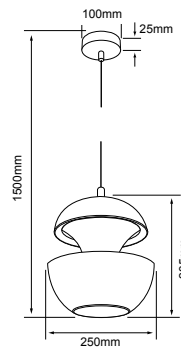

AUVA II
20CTL1942MVN

Potencia máx.: 60 W
Volts: 100-240 V ~

Terminado: Negro Mate /
Interior Cobre
Tipo de base: E27
Tipo de lámpara: Opcional
(No incluida)



INTERIOR
ORO

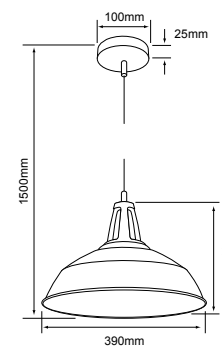

AGORA
60CTL1300MVN

Potencia máx.: 60 W
Volts: 100-240 V ~

Terminado: Negro Mate /
Oro
Tipo de base: E27
Tipo de lámpara: Opcional
(No incluida)

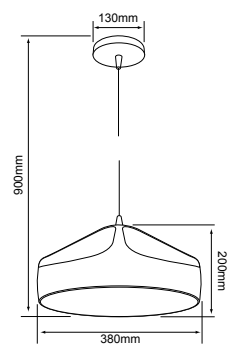

URSA II
CTL-1940/N

Potencia máx.: 60 W
Volts: 100-240 V ~

Terminado: Negro / Cobre
Tipo de base: E27
Tipo de lámpara: Opcional
(No incluida)



B



N



B



N



INTERIOR
ORO

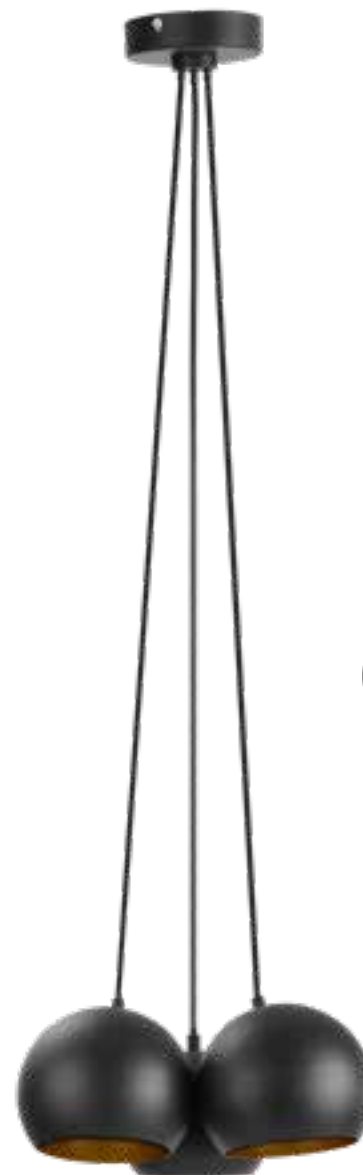

INTERIOR
ORO

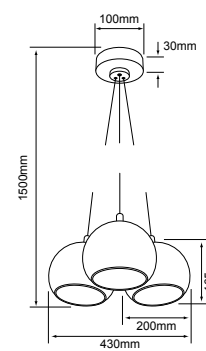
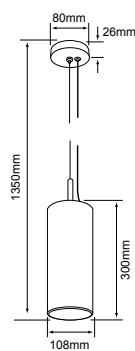
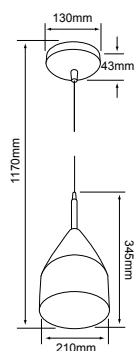

AUVA
CTL-7432/B
Blanco / Cobre

CTL-7432/N
Negro / Cobre

AUVA III
20CTL154MVB
Blanco

20CTL154MVN
Negro Mate / Oro

AGORA III
20CTL8187MVN

Potencia máx.: 60 W
Volts: 100-240 V ~

Tipo de base: E27
Tipo de lámpara: Opcional (No incluida)

Potencia máx.: 60 W
Volts: 100-240 V ~

Tipo de base: E27
Tipo de lámpara: Opcional (No incluida)

Potencia máx.: 180 W
Volts: 100-240 V ~

Terminado: Negro Mate / Oro
Tipo de base: E27
Tipo de lámpara: Opcional (No incluida)



MERIDIANA
60CTL3310MVCO Cobre

Potencia máx.: 60 W
Volts: 100-240 V ~

60CTL3310MVN Negro

Tipo de base: E27
Tipo de lámpara: Opcional (No incluida)



RASALAS
60CTL7435MVB Blanco

Potencia máx.: 60 W
Volts: 100-240 V ~

60CTL7435MVN Negro

Tipo de base: E27
Tipo de lámpara: Opcional (No incluida)

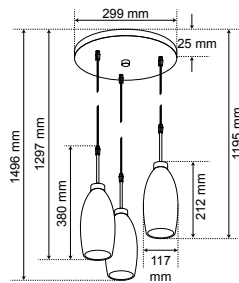

MARUK II
180CTL1003MVOP

Potencia máx.: 180 W
Volts: 100-240 V ~

Terminado: Cristal opalino
Tipo de base: E27 x 3
Tipo de lámpara: Opcional
(No incluida)

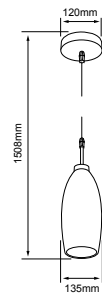

MARUK
60CTL1000MVOP

Potencia máx.: 60 W
Volts: 100-240 V ~

Terminado: Cristal opalino
Tipo de base: E27
Tipo de lámpara: Opcional (No incluida)

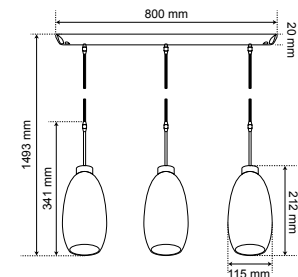

MARUK III
180CTL1033MVOP

Potencia máx.: 180 W
Volts: 100-240 V ~

Terminado: Cristal opalino
Tipo de base: E27 x 3
Tipo de lámpara: Opcional (No incluida)

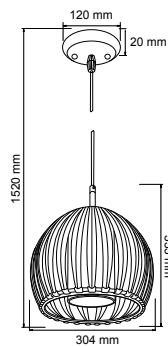

BAMIO
60CTL8062MVCL

Potencia máx.: 60 W
Volts: 100-240 V ~

Terminado: PC / Cristal opalino
Tipo de base: E27
Tipo de lámpara: Opcional (No incluida)

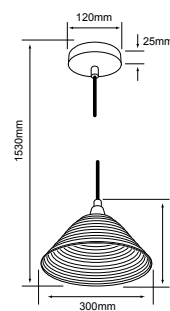

BAMIRA
60CTL0006MVOP

Potencia máx.: 60 W
Volts: 100-240 V ~

Terminado: Cristal opalino
Tipo de base: E27
Tipo de lámpara: Opcional (No incluida)

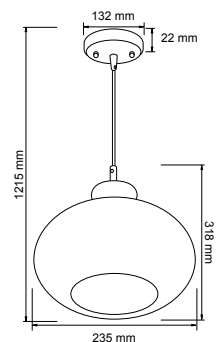

LUXOR
CTL-8052/OP

Potencia máx.: 60 W
Volts: 100-240 V ~

Terminado: Cristal opalino
Tipo de base: E27
Tipo de lámpara: Opcional (No incluida)

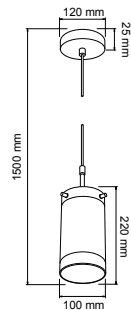

BAMBERA
60CTL0003MVOP

Potencia máx.: 60 W
Volts: 100-240 V ~

Terminado: Cristal opalino
Tipo de base: E27
Tipo de lámpara: Opcional
(No incluida)

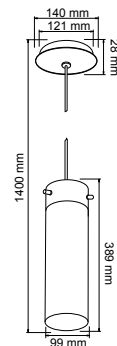

LIMENA
60CTL1701MVS
CTL-1701/S

Potencia máx.: 60 W
Volts: 100-240 V ~

Terminado: Satinado/PC opalino
Tipo de base: E27
Tipo de lámpara: Opcional (No incluida)

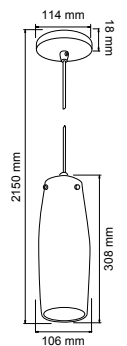

LONDRA
CTL-8087/OP

Potencia máx.: 60 W
Volts: 100-240 V ~

Terminado: Cristal opalino
Tipo de base: E27
Tipo de lámpara: Opcional (No incluida)

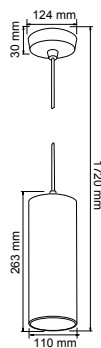

LERIDA
CTL-8100/S

Potencia máx.: 60 W
Volts: 100-240 V ~

Terminado: Cristal opalino
Tipo de base: E27
Tipo de lámpara: Opcional
(No incluida)

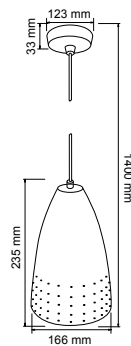
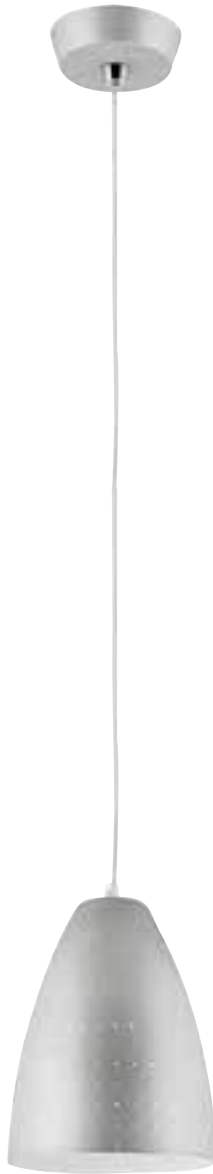

LORETO
CTL-7430/S

Potencia máx.: 60 W
Volts: 100-240 V ~

Terminado: Satinado
Tipo de base: E27
Tipo de lámpara: Opcional
(No incluida)

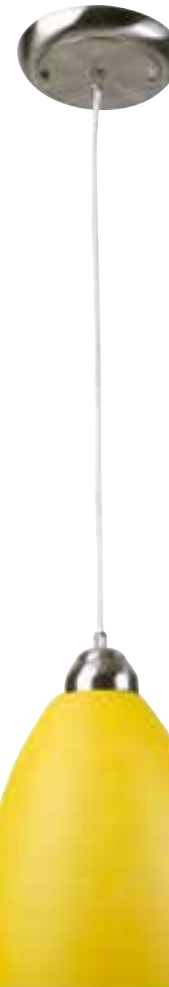

AM

MASSA
20CTL1900MVAM
Cristal Ámbar

Potencia máx.: 60 W
Volts: 100-240 V ~



OP

20CTL1900MVOP
Cristal opalino

Tipo de base: E27
Tipo de lámpara: Opcional (No incluida)

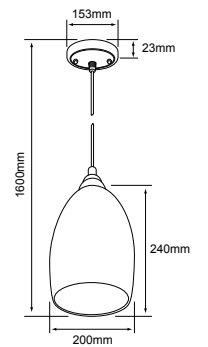



INTERIOR / de luminario
color blanco

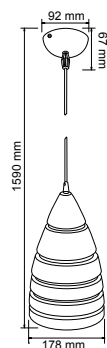

LUINI
CTL-7460/AL

Potencia máx.: 60 W
Volts: 100-240 V ~

Terminado: Aluminio
Tipo de base: E27
Tipo de lámpara: Opcional (No incluida)

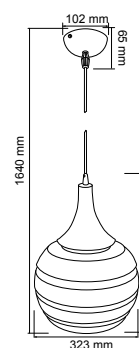

MARINO
CTL-7410/AL

Potencia máx.: 60 W
Volts: 100-240 V ~

Terminado: Aluminio
Tipo de base: E27
Tipo de lámpara: Opcional (No incluida)

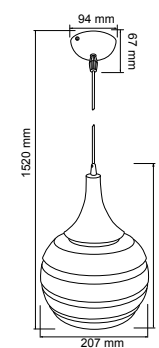

MARINO I
CTL-7405/AL

Potencia máx.: 60 W
Volts: 100-240 V ~

Terminado: Aluminio
Tipo de base: E27
Tipo de lámpara: Opcional (No incluida)

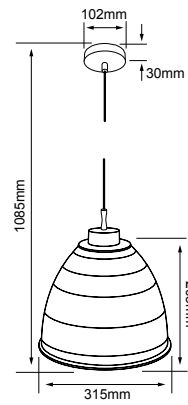

LUCCA
CTL-8070/S

Potencia máx.: 60 W
Volts: 100-240 V ~

Terminado: PC rayado
Tipo de base: E27
Tipo de lámpara: Opcional (No incluida)

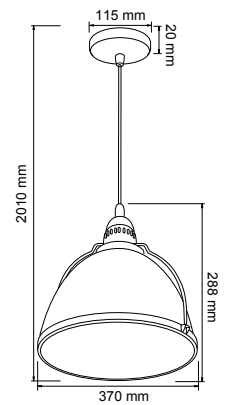

LOME
CTL-8073/CR

Potencia máx.: 60 W
Volts: 100-240 V ~

Terminado: Cromado / PC rayado
Tipo de base: E27
Tipo de lámpara: Opcional (No incluida)



ACAMAR
48DPTLLED605CCTMVB

TEMPERATURA DE COLOR AJUSTABLE

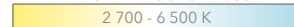

Lumens: **4 800 lm**
Potencia: **48 W**
Volts: 100-240 V ~

Terminado: **Blanco**
IRC: **80**
Vida útil: **30 000 h**
Ángulo: **120 °**
Tipo de lámpara: **LED (integrado)**
Atenuable: Si
Cambio de temperatura de color y atenuación con control remoto. Incluido

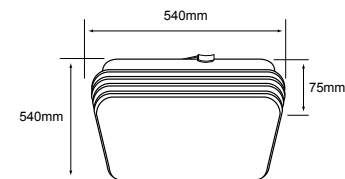

ALBALI II
80DPTLLED933CCTMVB

TEMPERATURA DE COLOR AJUSTABLE

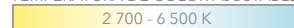

Lumens: **6 500 lm**
Potencia: **80 W**
Volts: 100-240 V ~

Terminado: **Blanco**
IRC: **80**
Vida útil: **30 000 h**
Ángulo: **120 °**
Tipo de lámpara: **LED (integrado)**
Atenuable: Si
Cambio de temperatura de color y atenuación con control remoto. Incluido

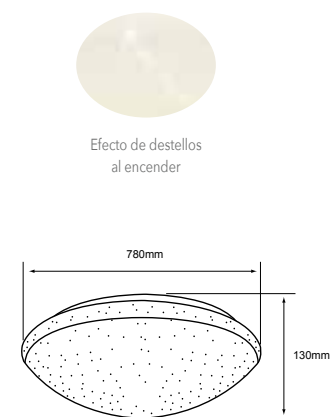

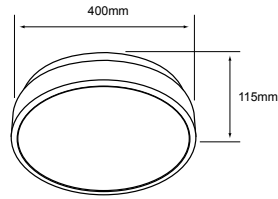

ACHERNAR I
24PTLLED927MV30S

LUZ SUAVE CÁLIDA
● 3 000 K

Lumens: **1 600 lm**
Potencia: 24 W
Volts: 100-240 V ~

Terminado: **Satinado**
IRC: 80
Vida útil: **30 000 h**
Ángulo: 120 °
Tipo de lámpara: LED (integrado)
Atenuable: **No**

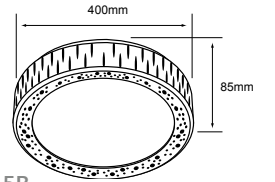

SACLATENI
24PTLLED930MV30B
LUZ SUAVE CÁLIDA
● 3 000 K

Lumens: **1 600 lm**
Potencia: 24 W
Volts: 100-240 V ~

24PTLLED930MV65B
LUZ DE DÍA
● 6 500 K

Terminado: **Blanco**
IRC: 80
Vida útil: **30 000 h**
Ángulo: 120 °
Tipo de lámpara: LED (integrado)
Atenuable: **No**



Efecto al encender

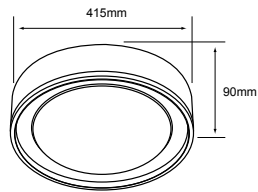

SABIK
24PTLLED926MV30B
LUZ SUAVE CÁLIDA
● 3 000 K

Lumens: **1 600 lm**
Potencia: 24 W
Volts: 100-240 V ~

24PTLLED926MV65B
LUZ DE DÍA
● 6 500 K

Terminado: **Blanco**
IRC: 80
Vida útil: **30 000 h**
Ángulo: 120 °
Tipo de lámpara: LED (integrado)
Atenuable: **No**

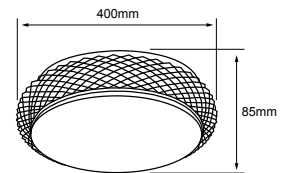

SADACHBIA
24PTLLED931MV30B
LUZ SUAVE CÁLIDA
● 3 000 K

Lumens: **1 600 lm**
Potencia: 24 W
Volts: 100-240 V ~

24PTLLED931MV65B
LUZ DE DÍA
● 6 500 K

Terminado: **Blanco**
IRC: 80
Vida útil: **30 000 h**
Ángulo: 120 °
Tipo de lámpara: LED (integrado)
Atenuable: **No**

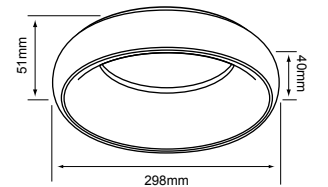

SATELITE II
PTLLED-005/30/N

LUZ SUAVE CÁLIDA
● 3 000 K

Lumens: **1 800 lm**
Potencia: 25 W
Volts: 100-240 V ~

Terminado: **Negro**
IRC: 80
Vida útil: **40 000 h**
Ángulo: 120 °
Tipo de lámpara: LED (Integrado)
Atenuable: **No**



IBIZA
PTLLED-01RD/9W/30
LUZ SUAVE CÁLIDA
● 3 000 K

Lumens: **500 lm**
Potencia: **9 W**
Volts: **127 V ~**

PTLLED-01RD/9W/65
LUZ DE DÍA
● 6 500 K

Terminado: **Satinado**
IRC: **80**
Vida útil: **25 000 h**
Ángulo: **110°**
Tipo de lámpara: **LED (Integrado)**
Atenuable: **No**



IBIZA I
PTLLED-01RD/12W/30
LUZ SUAVE CÁLIDA
● 3 000 K

Lumens: **700 lm**
Potencia: **12 W**
Volts: **127 V ~**

PTLLED-01RD/12W/65
LUZ DE DÍA
● 6 500 K

Terminado: **Satinado**
IRC: **80**
Vida útil: **25 000 h**
Ángulo: **110°**
Tipo de lámpara: **LED (Integrado)**
Atenuable: **No**



IBIZA II
PTLLED-01RD/15W/30
LUZ SUAVE CÁLIDA
● 3 000 K

Lumens: **900 lm**
Potencia: **15 W**
Volts: **127 V ~**

PTLLED-01RD/15W/65
LUZ DE DÍA
● 6 500 K

Terminado: **Satinado**
IRC: **80**
Vida útil: **25 000 h**
Ángulo: **110°**
Tipo de lámpara: **LED (Integrado)**
Atenuable: **No**

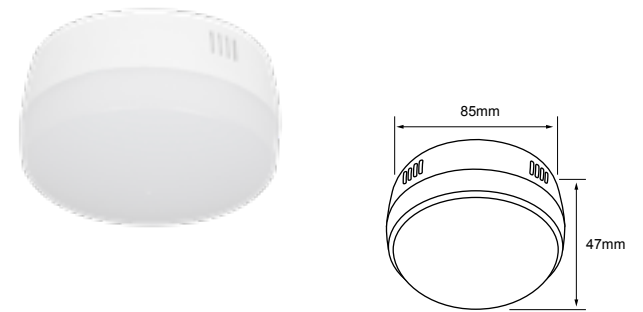

C-DOMUS I
7PTLLED4030MV40B

LUZ BLANCA NEUTRA
○ 4 000 K

Lumens: **650 lm**
Potencia: **7 W**
Volts: **100-240 V ~**

Terminado: **Blanco**
IRC: **80**
Vida útil: **25 000 h**
Ángulo: **100°**
Tipo de lámpara: **LED (Integrado)**
Atenuable: **No**

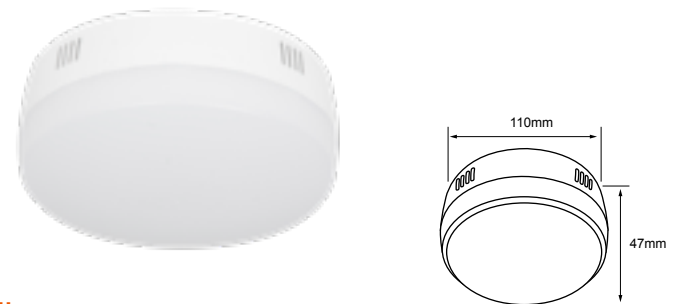

C-DOMUS II
09PTLLED4031MV40B

LUZ BLANCA NEUTRA
○ 4 000 K

Lumens: **890 lm**
Potencia: **9 W**
Volts: **100-240 V ~**

Terminado: **Blanco**
IRC: **80**
Vida útil: **25 000 h**
Ángulo: **100°**
Tipo de lámpara: **LED (Integrado)**
Atenuable: **No**



C-DOMUS III
12PTLLED4032MV40B

LUZ BLANCA NEUTRA
○ 4 000 K

Lumens: **1180 lm**
Potencia: **12 W**
Volts: **100-240 V ~**

Terminado: **Blanco**
IRC: **80**
Vida útil: **25 000 h**
Ángulo: **100°**
Tipo de lámpara: **LED (Integrado)**
Atenuable: **No**

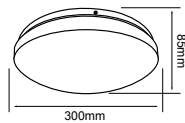

ANSER
FC-LEDRL/004/65

LUZ DE DÍA
● 6 500 K

Lumens: **1 200 lm**
Potencia: 16 W
Volts: 100-240 V ~

Terminado: **Blanco**
IRC: **80**
Vida útil: **15 000 h**
Ángulo: **100 °**
Tipo de lámpara: **LED (Integrado)**
Atenuable: **No**

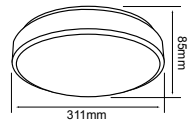

ANSER I
FC-LEDRL/004/30/B
LUZ SUAVE CÁLIDA
● 3 000 K
Lumens: **1 100 lm**

Potencia: 16 W
Volts: 100-240 V ~

FC-LEDRL/004/65/B
LUZ DE DÍA
● 6 500 K
Lumens: **1 200 lm**

Terminado: **Blanco**
IRC: **80**
Vida útil: **15 000 h**
Ángulo: **100 °**
Tipo de lámpara: **LED (Integrado)**
Atenuable: **No**

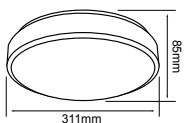

ANSER II
FC-LEDRL/004/30/S
LUZ SUAVE CÁLIDA
● 3 000 K
Lumens: **1 100 lm**

Potencia: 16 W
Volts: 100-240 V ~

FC-LEDRL/004/65/S
LUZ DE DÍA
● 6 500 K
Lumens: **1 200 lm**

Terminado: **Blanco/Satin**
IRC: **80**
Vida útil: **15 000 h**
Ángulo: **100 °**
Tipo de lámpara: **LED (Integrado)**
Atenuable: **No**

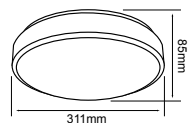

ANSER III
FC-LEDRL/004/30/R
LUZ SUAVE CÁLIDA
● 3 000 K
Lumens: **1 100 lm**

Potencia: 16 W
Volts: 100-240 V ~

FC-LEDRL/004/65/R
LUZ DE DÍA
● 6 500 K
Lumens: **1 200 lm**

Terminado: **Blanco/Cobre Rosado**
IRC: **80**
Vida útil: **15 000 h**
Ángulo: **100 °**
Tipo de lámpara: **LED (Integrado)**
Atenuable: **No**

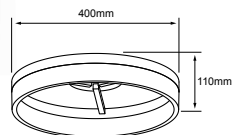

KAITOS II
25DPTLLED206V30S

LUZ SUAVE CÁLIDA
● 3 000 K

Lumens: **1 332 lm**
Potencia: 25 W
Volts: 127 V ~

Terminado: **Satinado**
IRC: **80**
Vida útil: **15 000 h**
Ángulo: **120 °**
Tipo de lámpara: **LED (integrado)**
Atenuable: **Si**

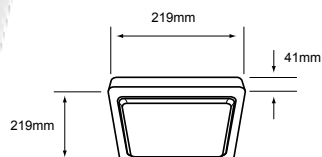

NASHIRA II
15PTLLED30MVB
LUZ SUAVE CÁLIDA
● 3 000 K

Lumens: **1 200 lm**
Potencia: 15 W
Volts: 100-240 V ~

15PTLLED30MVB
LUZ DE DÍA
● 6 500 K

Terminado: **Blanco**
IRC: **80**
Vida útil: **15 000 h**
Ángulo: **110 °**
Tipo de lámpara: **LED (Integrado)**
Atenuable: **No**

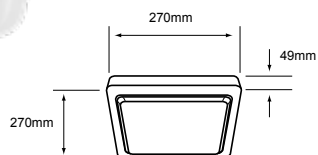

NASHIRA III
20PTLLED30MVB
LUZ SUAVE CÁLIDA
● 3 000 K

Lumens: **1 600 lm**
Potencia: 20 W
Volts: 100-240 V ~

20PTLLED30MVB
LUZ DE DÍA
● 6 500 K

Terminado: **Blanco**
IRC: **80**
Vida útil: **15 000 h**
Ángulo: **110 °**
Tipo de lámpara: **LED (Integrado)**
Atenuable: **No**

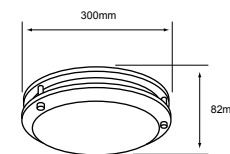

PORTLAND
15DPTLLED003V30S

LUZ SUAVE CÁLIDA
● 3 000 K

Lumens: **1 000 lm**
Potencia: 15 W
Volts: 127 V ~

Terminado: **Satinado**
IRC: **80**
Vida útil: **30 000 h**
Ángulo: **120 °**
Tipo de lámpara: **LED (Integrado)**
Atenuable: **Si**

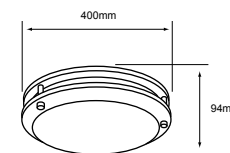

PORTLAND I
25DPTLLED003V30S

LUZ SUAVE CÁLIDA
● 3 000 K

Lumens: **1 350 lm**
Potencia: 25 W
Volts: 127 V ~

Terminado: **Satinado**
IRC: **80**
Vida útil: **25 000 h**
Ángulo: **110 °**
Tipo de lámpara: **LED (Integrado)**
Atenuable: **Si**

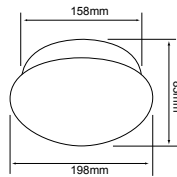

AUSTRAL
PTLLED/012/30
LUZ SUAVE CÁLIDA
● 3 000 K
Lumens: **700 lm**

PTLLED/012/65
LUZ DE DÍA
● 6 500 K
Lumens: **800 lm**

Potencia: **12 W**
Volts: **100-240 V ~**

Terminado: **Blanco**
IRC: **80**
Vida útil: **15 000 h**
Ángulo: **100 °**
Tipo de lámpara: **LED (Integrado)**
Atenuable: **No**

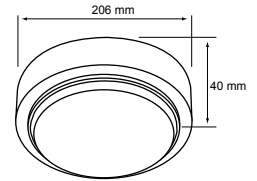

PADANG
PTLLED-1010/30
LUZ SUAVE CÁLIDA
● 3 000 K
Lumens: **700 lm**

PTLLED-1010/65
LUZ DE DÍA
● 6 500 K

Potencia: **10 W**
Volts: **100-240 V ~**

Terminado: **Blanco**
IRC: **80**
Vida útil: **25 000 h**
Ángulo: **120 °**
Tipo de lámpara: **LED (Integrado)**
Atenuable: **No**

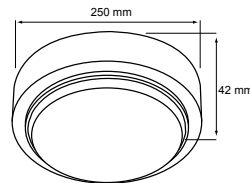

PADANG I
PTLLED-1015/65

LUZ DE DÍA
● 6 500 K

Lumens: **1 050 lm**
Potencia: **15 W**
Volts: **100-240 V ~**

Terminado: **Blanco**
IRC: **80**
Vida útil: **25 000 h**
Ángulo: **120 °**
Tipo de lámpara: **LED (Integrado)**
Atenuable: **No**

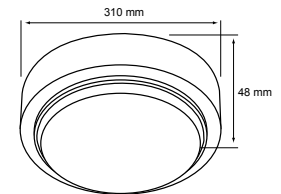

PADANG II
PTLLED-1020/30
LUZ SUAVE CÁLIDA
● 3 000 K
Lumens: **1 400 lm**

PTLLED-1020/65
LUZ DE DÍA
● 6 500 K

Potencia: **20 W**
Volts: **100-240 V ~**

Terminado: **Blanco**
IRC: **80**
Vida útil: **25 000 h**
Ángulo: **120 °**
Tipo de lámpara: **LED (Integrado)**
Atenuable: **No**

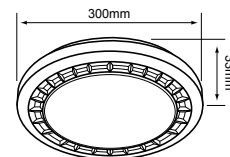

ZETA
PTLLEDR-006/40/B

LUZ BLANCA NEUTRA
○ 4 000 K

Lumens: **1 800 lm**
Potencia: **15 W**
Volts: **100-240 V ~**

Terminado: **Blanco**
IRC: **80**
Vida útil: **40 000 h**
Ángulo: **100 °**
Tipo de lámpara: **LED (Integrado)**
Atenuable: **No**

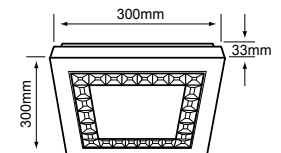

ZETA I
PTLLEDC-006/40/B

LUZ BLANCA NEUTRA
○ 4 000 K

Lumens: **1 800 lm**
Potencia: **15 W**
Volts: **100-240 V ~**

Terminado: **Blanco**
IRC: **80**
Vida útil: **40 000 h**
Ángulo: **100 °**
Tipo de lámpara: **LED (Integrado)**
Atenuable: **No**



ALGEDI I

6PTLLEDC30MVB

LUZ SUAVE CÁLIDA

● 3 000 K

Lumens: **320 lm**

Potencia: 6 W

Volts: 100-240 V ~

6PTLLEDC65MVB

LUZ DE DÍA

● 6 500 K

Lumens: **350 lm**

Terminado: Blanco

IRC: 80

Vida útil: **15 000 h**

Ángulo: 100 °

Tipo de lámpara: LED (Integrado)

Atenuable: No

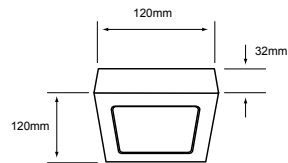

ALGEDI III

18PTLLEDC30MVB

LUZ SUAVE CÁLIDA

● 3 000 K

Lumens: **1 200 lm**

Potencia: 18 W

Volts: 100-240 V ~

18PTLLEDC65MVB

LUZ DE DÍA

● 6 500 K

Lumens: **1 300 lm**

Terminado: Blanco

IRC: 80

Vida útil: **15 000 h**

Ángulo: 100 °

Tipo de lámpara: LED (Integrado)

Atenuable: No

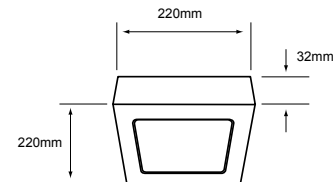

ALGEDI II

12PTLLEDC30MVB

LUZ SUAVE CÁLIDA

● 3 000 K

Lumens: **720 lm**

Potencia: 12 W

Volts: 100-240 V ~

12PTLLEDC65MVB

LUZ DE DÍA

● 6 500 K

Lumens: **800 lm**

Terminado: Blanco

IRC: 80

Vida útil: **15 000 h**

Ángulo: 100 °

Tipo de lámpara: LED (Integrado)

Atenuable: No

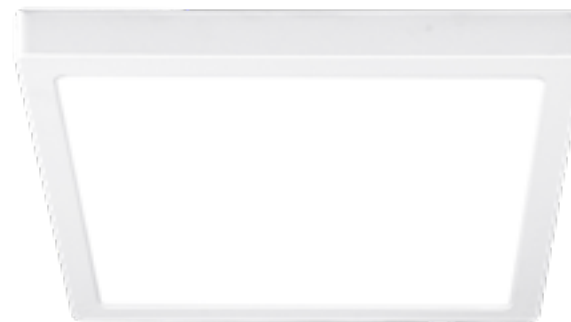
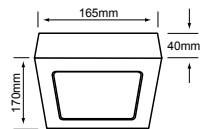

ALGEDI IV

24PTLLEDC30MVB

LUZ SUAVE CÁLIDA

● 3 000 K

Lumens: **1 600 lm**

Potencia: 24 W

Volts: 100-240 V ~

24PTLLEDC65MVB

LUZ DE DÍA

● 6 500 K

Terminado: Blanco

IRC: 80

Vida útil: **15 000 h**

Ángulo: 150 °

Tipo de lámpara: LED (integrado)

Atenuable: No

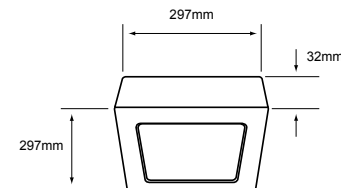

SIRIUS II

PTLLEDD-C/002/40/B

LUZ BLANCA NEUTRA
○ 4 000 K

Lumens: **750 lm**

Potencia: 12 W

Volts: 100-127 V ~

Terminado: Blanco

IRC: 80

Vida útil: **15 000 h**

Ángulo: 100 °

Tipo de lámpara: LED (Integrado)

Atenuable: Si

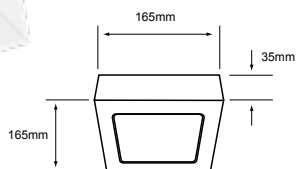



ANKAA I

6PTLLEDR30MVB
 LUZ SUAVE CÁLIDA
 ● 3 000 K
 Lumens: **320 lm**

Potencia: 6 W
 Volts: 100-240 V ~

6PTLLEDR65MVB
 LUZ DE DÍA
 ● 6 500 K
 Lumens: **350 lm**

Terminado: Blanco
 IRC: 80
 Vida útil: **15 000 h**
 Ángulo: 100 °
 Tipo de lámpara: LED (Integrado)
 Atenuable: No

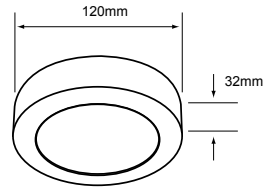

ANKAA III

18PTLLEDR30MVB
 LUZ SUAVE CÁLIDA
 ● 3 000 K
 Lumens: **1 200 lm**

Potencia: 18 W
 Volts: 100-240 V ~

18PTLLEDR65MVB
 LUZ DE DÍA
 ● 6 500 K
 Lumens: **1 300 lm**

Terminado: Blanco
 IRC: 80
 Vida útil: **15 000 h**
 Ángulo: 100 °
 Tipo de lámpara: LED (Integrado)
 Atenuable: No

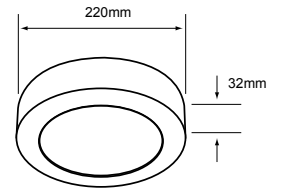

ANKAA II

12PTLLEDR30MVB
 LUZ SUAVE CÁLIDA
 ● 3 000 K
 Lumens: **720 lm**

Potencia: 12 W
 Volts: 100-240 V ~

12PTLLEDR65MVB
 LUZ DE DÍA
 ● 6 500 K
 Lumens: **800 lm**

Terminado: Blanco
 IRC: 80
 Vida útil: **15 000 h**
 Ángulo: 100 °
 Tipo de lámpara: LED (Integrado)
 Atenuable: No

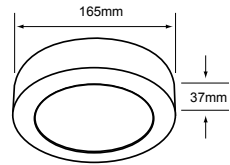

ANKAA IV

24PTLLEDR30MVB
 LUZ SUAVE CÁLIDA
 ● 3 000 K
 Lumens: **1 600 lm**

Potencia: 24 W
 Volts: 100-240 V ~

24PTLLEDR65MVB
 LUZ DE DÍA
 ● 6 500 K
 Lumens: **1 700 lm**

Terminado: Blanco
 IRC: 80
 Vida útil: **15 000 h**
 Ángulo: 150 °
 Tipo de lámpara: LED (integrado)
 Atenuable: No

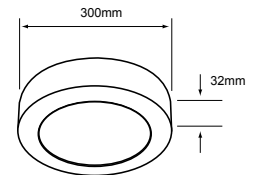

SIRIUS III

PTLLEDD-R/002/40/B

LUZ BLANCA NEUTRA
 ○ 4 000 K
 Lumens: **750 lm**

Potencia: 12 W
 Volts: 100-127 V ~

Terminado: Blanco
 IRC: 80
 Vida útil: **15 000 h**
 Ángulo: 100 °
 Tipo de lámpara: LED (Integrado)
 Atenuable: Si

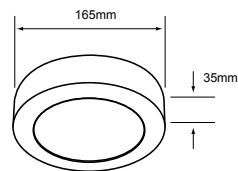

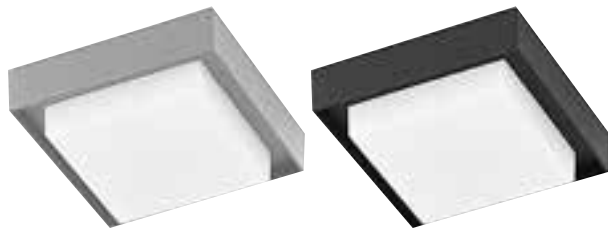

Protección contra ingreso limitado de polvo. (No incluye materiales peligrosos)

IP

54

Protección contra salpicaduras de gotas en todas direcciones, el ingreso de cantidades limitadas de agua es permitido.

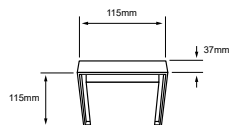

NUEVO

OKAB I

15PTLLED1131CV30G

Gris

Lumens: **810 lm**

15PTLLED1131CV30N

Negro

Lumens: **760 lm**

LUZ SUAVE CÁLIDA
● 3 000 K

Potencia: 15 W
Volts: 127 V ~

IRC: 80
Vida útil: **15 000 h**
Ángulo: 120°
IP: 54
Tipo de lámpara: LED (Integrado)
Atenuable: No



Protección contra ingreso limitado de polvo. (No incluye materiales peligrosos)

IP

54

Protección contra salpicaduras de gotas en todas direcciones, el ingreso de cantidades limitadas de agua es permitido.

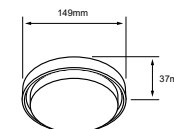

NUEVO

NENQUE I

15PTLLED1131RV30G

Gris

Lumens: **850 lm**

15PTLLED1131RV30N

Negro

Lumens: **790 lm**

LUZ SUAVE CÁLIDA
● 3 000 K

Potencia: 15 W
Volts: 127 V ~

IRC: 80
Vida útil: **15 000 h**
Ángulo: 120°
IP: 54
Tipo de lámpara: LED (Integrado)
Atenuable: No

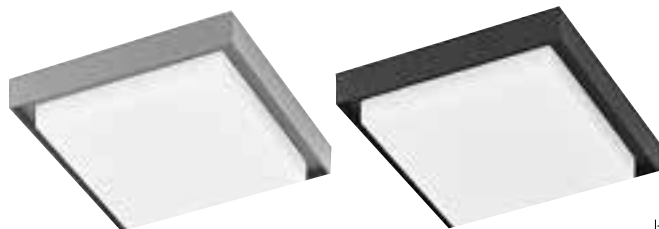

Protección contra ingreso limitado de polvo. (No incluye materiales peligrosos)

IP

54

Protección contra salpicaduras de gotas en todas direcciones, el ingreso de cantidades limitadas de agua es permitido.

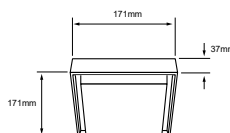

NUEVO

OKAB II

24PTLLED1132CV30G

Gris

Lumens: **1400 lm**

24PTLLED1132CV30N

Negro

Lumens: **1300 lm**

LUZ SUAVE CÁLIDA
● 3 000 K

Potencia: 24 W
Volts: 127 V ~

IRC: 80
Vida útil: **15 000 h**
Ángulo: 120°
IP: 54
Tipo de lámpara: LED (Integrado)
Atenuable: No



Protección contra ingreso limitado de polvo. (No incluye materiales peligrosos)

IP

54

Protección contra salpicaduras de gotas en todas direcciones, el ingreso de cantidades limitadas de agua es permitido.

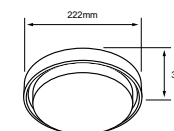

NUEVO

NENQUE II

24PTLLED1132RV30G

Gris

Lumens: **1490 lm**

24PTLLED1132RV30N

Negro

Lumens: **1400 lm**

LUZ SUAVE CÁLIDA
● 3 000 K

Potencia: 24 W
Volts: 127 V ~

IRC: 80
Vida útil: **15 000 h**
Ángulo: 120°
IP: 54
Tipo de lámpara: LED (Integrado)
Atenuable: No

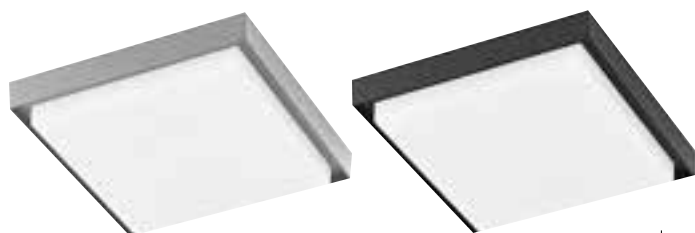

Protección contra ingreso limitado de polvo. (No incluye materiales peligrosos)

IP

54

Protección contra salpicaduras de gotas en todas direcciones, el ingreso de cantidades limitadas de agua es permitido.

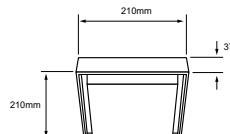

NUEVO

OKAB III

35PTLLED1133CV30G

Gris

Lumens: **2100 lm**

35PTLLED1133CV30N

Negro

Lumens: **2000 lm**

LUZ SUAVE CÁLIDA
● 3 000 K

Potencia: 35 W
Volts: 127 V ~

IRC: 80
Vida útil: **15 000 h**
Ángulo: 120°
IP: 54
Tipo de lámpara: LED (Integrado)
Atenuable: No



Protección contra ingreso limitado de polvo. (No incluye materiales peligrosos)

IP

54

Protección contra salpicaduras de gotas en todas direcciones, el ingreso de cantidades limitadas de agua es permitido.

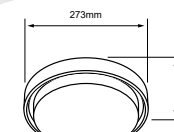

NUEVO

NENQUE III

35PTLLED1133RV30G

Gris

Lumens: **2200 lm**

35PTLLED1133RV30N

Negro

Lumens: **2000 lm**

LUZ SUAVE CÁLIDA
● 3 000 K

Potencia: 35 W
Volts: 127 V ~

IRC: 80
Vida útil: **15 000 h**
Ángulo: 120°
IP: 54
Tipo de lámpara: LED (Integrado)
Atenuable: No

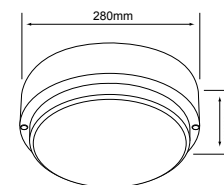
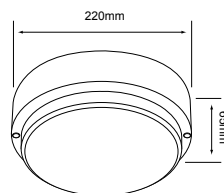

Totalmente protegido
contra polvo.
Totalmente sellado.

IP 65

Protegido contra chorros
de agua a baja presión, el ingreso
limitado de agua es permitido

LACERTA

PTLLED-1110/40/B
LUZ BLANCA NEUTRA
○ 4 000 K

PTLLED-1110/65/B
LUZ DE DIA
● 6 500 K

Lumens: 800 lm
Potencia: 9 W
Volts: 100-240 V ~

Terminado: **Blanco**
IRC: **80**
Vida útil: **20 000 h**
Ángulo: **115°**
IP: **65**
Tipo de lámpara: **LED (Integrado)**
Atenuable: **No**



Totalmente protegido
contra polvo.
Totalmente sellado.

IP 65

Protegido contra chorros
de agua a baja presión, el ingreso
limitado de agua es permitido

LACERTA I

PTLLED-1120/40/B
LUZ BLANCA NEUTRA
○ 4 000 K

PTLLED-1120/65/B
LUZ DE DIA
● 6 500 K

Lumens: 1 500 lm
Potencia: 18 W
Volts: 100-240 V ~

Terminado: **Blanco**
IRC: **80**
Vida útil: **20 000 h**
Ángulo: **115°**
IP: **65**
Tipo de lámpara: **LED (Integrado)**
Atenuable: **No**



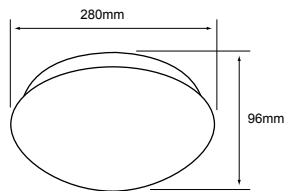
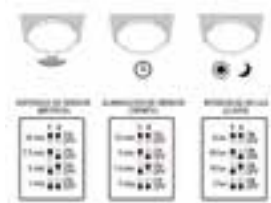

SARGAS
12PTLLED013SMV30
LUZ SUAVE CÁLIDA
● 3 000 K

12PTLLED013SMV65
LUZ DE DÍA
● 6 500 K

Lumens: **800 lm**
Potencia: **12 W**
Volts: **100-240 V ~**

Terminado: **Blanco**
IRC: **80**
Vida útil: **30 000 h**
Ángulo: **120 °**
Tipo de lámpara: **LED (integrado)**
Atenuable: **No**
Sensor de movimiento

RETIRA LA TAPA
CONFIGURA EL LUMINARIO

DISTANCIA METROS	TIEMPO	INTENSIDAD LUXES
10 m <input type="checkbox"/> 1 <input type="checkbox"/> 2	5 seg <input type="checkbox"/> 3 <input type="checkbox"/> 4	OFF <input type="checkbox"/> 5 <input type="checkbox"/> 6
7.5 m <input type="checkbox"/> 1 <input type="checkbox"/> 2	90 seg <input type="checkbox"/> 3 <input type="checkbox"/> 4	50 lux <input type="checkbox"/> 5 <input type="checkbox"/> 6
5 m <input type="checkbox"/> 1 <input type="checkbox"/> 2	5 min <input type="checkbox"/> 3 <input type="checkbox"/> 4	10 lux <input type="checkbox"/> 5 <input type="checkbox"/> 6
1 m <input type="checkbox"/> 1 <input type="checkbox"/> 2	15 min <input type="checkbox"/> 3 <input type="checkbox"/> 4	2 lux <input type="checkbox"/> 5 <input type="checkbox"/> 6

AHORRA LUZ Y HAZ QUE SE ENCIENDA CUANDO SEA NECESARIO

1. ELIGE LA DISTANCIA PARA ACTIVAR LA LUZ

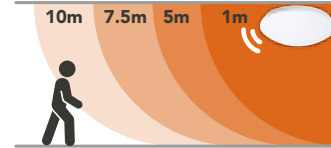

2. ELIGE EL TIEMPO DE ENCENDIDO

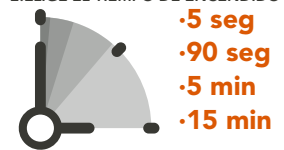

3. ELIGE LA INTENSIDAD DE LUZ



COLUMBUS
PTLELED/004/65/B

LUZ DE DÍA
● 6 500 K

Lumens: **1 100 lm**
Potencia: **13 W**
Volts: **100-240 V ~**

Aplicación: **Directo al socket**
Terminado: **Blanco**
IRC: **80**
Vida útil: **25 000 h**
Ángulo: **100 °**
Tipo de base: **E27**
Tipo de lámpara: **LED (Integrado)**
Atenuable: **No**

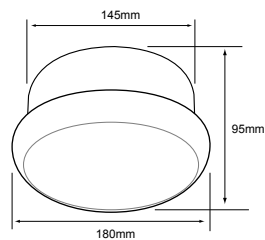

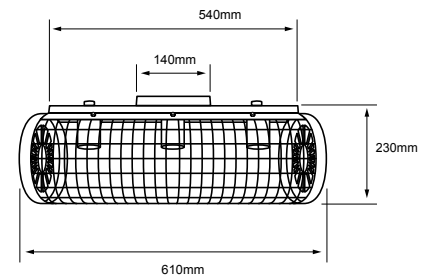

PIAUTOS II
180PTL1416MVOX

Potencia máx.: 180 W
Volts: 100-240 V ~

Terminado: Oximo
Tipo de base: E27 x 3
Tipo de lámpara: Opcional (No incluida)

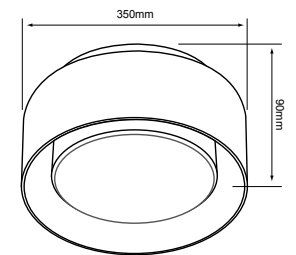

URSA
PTL-1940/N

Potencia: 120 W
Volts: 100-240 V ~

Terminado: Negro Mate / Cobre
Tipo de base: E27 x 2
Tipo de lámpara: OPCIONAL x 2 (No incluida)

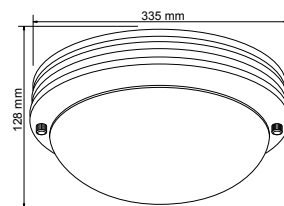

GAMBERI
PTL-7080/S

Potencia máx.: 120 W
Volts: 100-240 V ~

Terminado: Satinado
Tipo de base: E27 x 2
Tipo de lámpara: Opcional (No incluida)

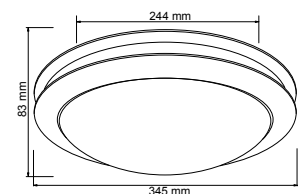

LATINA I
120PTL5030MVS

Potencia máx.: 120 W
Volts: 100-240 V ~

Terminado: Satinado
Tipo de base: E27 x 2
Tipo de lámpara: Opcional (No incluida)

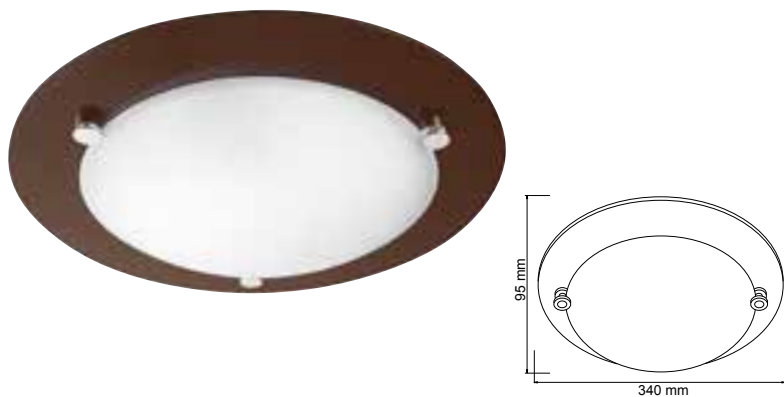

FORLI
PTL-5025/M

Potencia máx.: 120 W
Volts: 100-240 V ~

Terminado: Madera oscura
Tipo de base: E27 X 2
Tipo de lámpara: Opcional (No incluida)



LECCO
PTL-2050/B

Potencia máx.: 120 W
Volts: 100-240 V ~

Terminado: Blanco
Tipo de base: E27 X 2
Tipo de lámpara: Opcional (No incluida)



IRLANDA
PTL-1900/S

Potencia máx.: 60 W
Volts: 100-240 V ~

Terminado: Satinado
Tipo de base: E27
Tipo de lámpara: Opcional (No incluida)

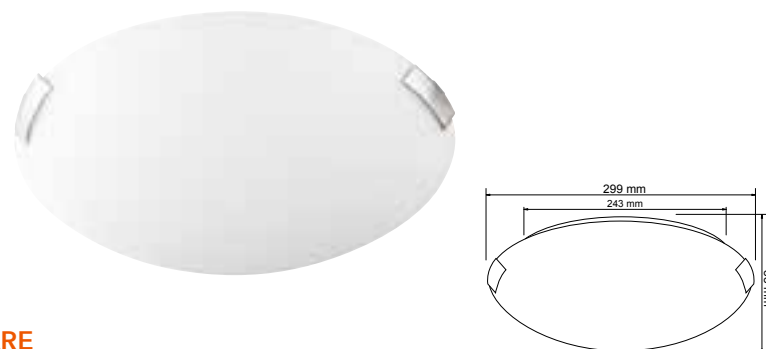

MARE
PTL-8520/S

Potencia máx.: 120 W
Volts: 100-240 V ~

Terminado: Satinado
Tipo de base: E27 x 2
Tipo de lámpara: Opcional (No incluida)



IUENA
PTL-1925/S

Potencia máx.: 60 W
Volts: 100-240 V ~

Terminado: Satinado
Tipo de base: E27
Tipo de lámpara: Opcional (No incluida)



LAZIO
PTL-5050/S

Potencia máx.: 120 W
Volts: 100-240 V ~

Terminado: Satinado
Tipo de base: E27 X 2
Tipo de lámpara: Opcional (No incluida)

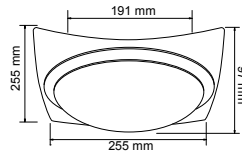

ISLANDÍA
PTL-1950/S

Potencia máx.: 60 W
Volts: 100-240 V ~

Terminado: **Satinado**
Tipo de base: **E27**
Tipo de lámpara: **Opcional (No incluida)**

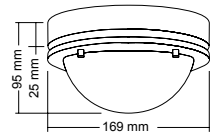

ITURRI
60PTL5110MVS

Potencia máx.: 60 W
Volts: 100-240 V ~ / 12 V ~

Terminado: **Satinado**
Tipo de base: **G9**
Tipo de lámpara: **G9 (No incluida)**

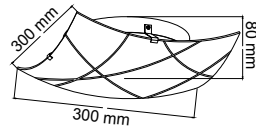

FOMENO
60PTL0002MVB

Potencia máx.: 60 W
Volts: 100-240 V ~

Terminado: **Blanco**
Tipo de base: **E27**
Tipo de lámpara: **Opcional (No incluida)**

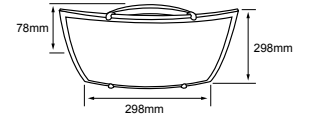

INOMOST
120PTL1011MVC

Potencia máx.: 120 W
Volts: 100-240 V ~

Terminado: **Cristal decorado**
Tipo de base: **E27 x 2**
Tipo de lámpara: **Opcional (No incluida)**

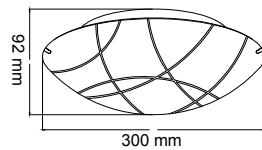

FORENTO
60PTL0001MVB

Potencia máx.: 60 W
Volts: 100-240 V ~

Terminado: **Blanco**
Tipo de base: **E27**
Tipo de lámpara: **Opcional (No incluida)**

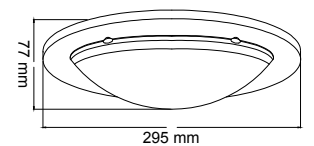

FOSHAN
60PTL0005MVS

Potencia máx.: 60 W
Volts: 100-240 V ~

Terminado: **Satinado**
Tipo de base: **E27**
Tipo de lámpara: **Opcional (No incluida)**

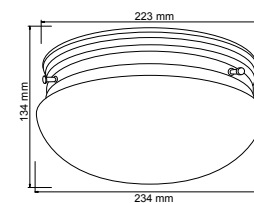

LENO II
PTL-1030/S

Potencia máx.: 120 W
Volts: 100-240 V ~

Terminado: **Satinado/Cristal**
Tipo de base: **E27 x 2**
Tipo de lámpara: **Opcional (No incluida)**



L

LENO III
PTL-1040/L
Latonado/Cristal

Potencia máx.: 120 W
Volts: 100-240 V ~



S

PTL-1040/S
Satinado/Cristal

Tipo de base: **E27 x 2**
Tipo de lámpara: **Opcional (No incluida)**

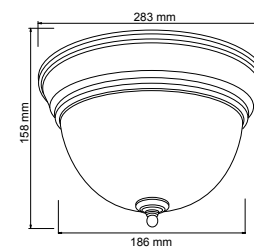

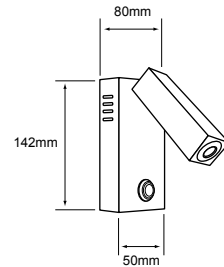

DELPHINUS I
TLLED-2051/B
Blanco

LUZ SUAVE CÁLIDA
● 3 000 K

Lumens: **140 lm**
Potencia: 3.4 W
Volts: 100-240 V ~

TLLED-2051/N
Negro

IRC: 80
Vida útil: **15 000 h**
Ángulo: 20°
Tipo de lámpara: LED (Integrado)
Atenuable: No
Dirigible

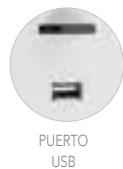

PUERTO
USB

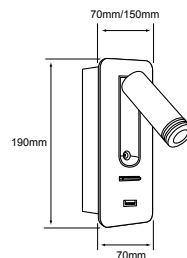

DELPHINUS II
3TLELED2053MV30B

LUZ SUAVE CÁLIDA
● 3 000 K

Lumens: **150 lm**
Potencia: 3.4 W
Volts: 100-240 V ~

Aplicación: **Empotrado en muro**
Terminado: **Blanco**
IRC: 80
Vida útil: **15 000 h**
Ángulo: 20°
Tipo de lámpara: LED (Integrado)
Corte de empotramiento: 59 mm x 172 mm
Atenuable: **No**
Dirigible
Incluye puerto **USB**

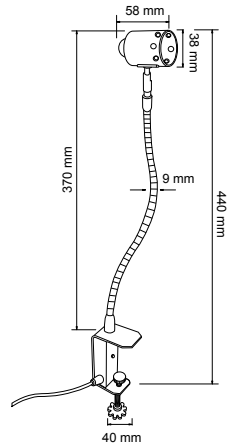

BELLA I
SS-050F/S

LUZ SUAVE CÁLIDA
● 3 000 K

Lumens: **250 lm**
Potencia: 6 W
Volts: 100-240 V ~

Terminado: **Satinado**
IRC: 80
Vida útil: **20 000 h**
Ángulo: 100°
Tipo de base: **GU10**
Tipo de lámpara: **LED 6W (Incluida)**
Atenuable: **No**
Flexible / Dirigible

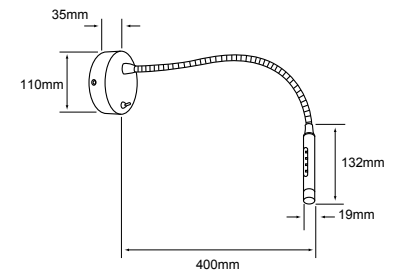

FREISING

TLLED-2030/S

LUZ SUAVE CÁLIDA
● 3 000 K

Lumens: **150 lm**
Potencia: 2 W
Volts: 100-240 V ~

Terminado: **Satinado**
IRC: 80
Vida útil: **15 000 h**
Ángulo: 120 °

Tipo de lámpara: **LED (Integrado)**
Atenuable: **No**
Flexible / Dirigible
Incluye apagador

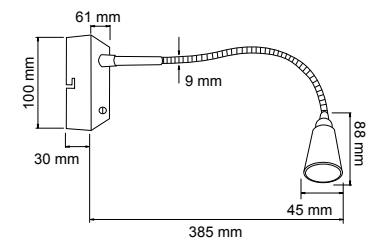
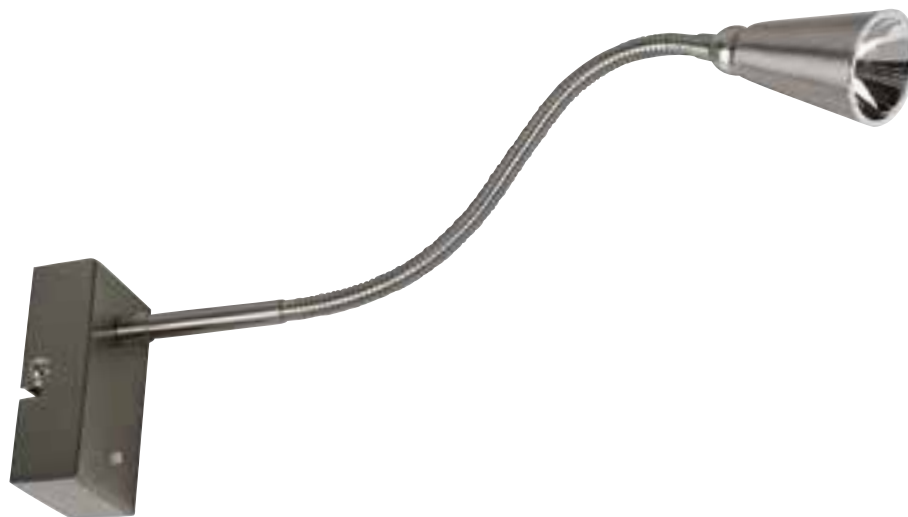

FROMBORK

TLLED-2000/S

LUZ DE DÍA
● 6 000 K

Lumens: **85 lm**
Potencia: 1 W
Volts: 100-240 V ~

Terminado: **Satinado**
IRC: 80
Vida útil: **15 000 h**
Ángulo: 120 °

Tipo de lámpara: **LED (Integrado)**
Atenuable: **No**
Flexible / Dirigible
Incluye apagador



BOTEIN
TLLED-2043/B

Potencia máx.: 60 W
Volts: 100-240 V ~

Terminado: Blanco
Vida útil: **25 000 h**
Tipo de lámpara: LED (Integrado)
Atenuable: No
Led dirigible 3.5 W, 145 lm
Incluye 2 puertos USB y apagador



BUNDA
TLLED-2042/B

Potencia máx.: 60 W
Volts: 100-240 V ~

Terminado: Blanco
Vida útil: **25 000 h**
Tipo de lámpara: LED (Integrado)
Atenuable: No
Led dirigible 1.5 W, 70 lm
Incluye 2 puertos USB y apagador



FLORES
TLLED-2040/B Blanco

Potencia máx.: 60 W
Volts: 100-240 V ~



TLLED-2040/N Negro

Vida útil: **15 000 h**
Tipo de base: E27
Tipo de lámpara: Opcional (No incluida)
Atenuable: No
Led dirigible 2 W, 70 lm
Incluye apagador

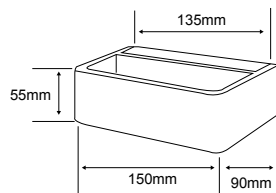

FAIS
TLLED-405/10W/30B

LUZ SUAVE CÁLIDA
● 3 000 K

Lumens: **450 lm**
Potencia: **10 W**
Volts: 100-240 V ~

Terminado: **Blanco**
IRC: **80**
Vida útil: **25 000 h**
Tipo de lámpara: **LED (Integrado)**
Atenuable: **No**

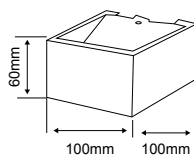
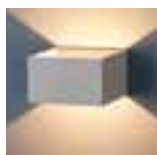

FUYU
TLLED-401/5.5W/30B

LUZ SUAVE CÁLIDA
● 3 000 K

Lumens: **250 lm**
Potencia: **5.5 W**
Volts: 100-240 V ~

Terminado: **Blanco**
IRC: **80**
Vida útil: **20 000 h**
Ángulo: **154 °**
Tipo de lámpara: **LED (Integrado)**
Atenuable: **No**

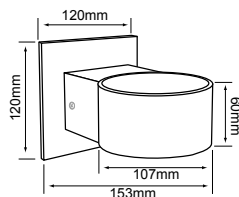

CANCRI
TLLED-407/30/N

LUZ SUAVE CÁLIDA
● 3 000 K

Lumens: **315 lm**
Potencia: **5.5 W**
Volts: 100-240 V ~

Terminado: **Negro**
IRC: **80**
Vida útil: **25 000 h**
Ángulo: **40°**
Tipo de lámpara: **LED (Integrado)**
Atenuable: **No**

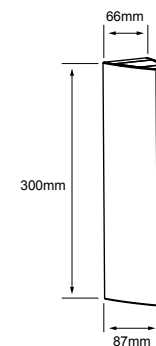

LEPUS
13TLLED504V30CR

LUZ SUAVE CÁLIDA
● 3 000 K

Lumens: **1 000 lm**
Potencia: **13.5 W**
Volts: 100-127 V ~

Terminado: **Cromado**
IRC: **80**
Vida útil: **20 000 h**
Ángulo: **90 °**
Tipo de lámpara: **LED (Integrado)**
Atenuable: **No**

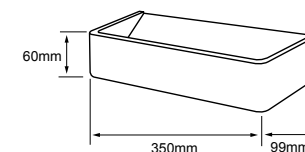
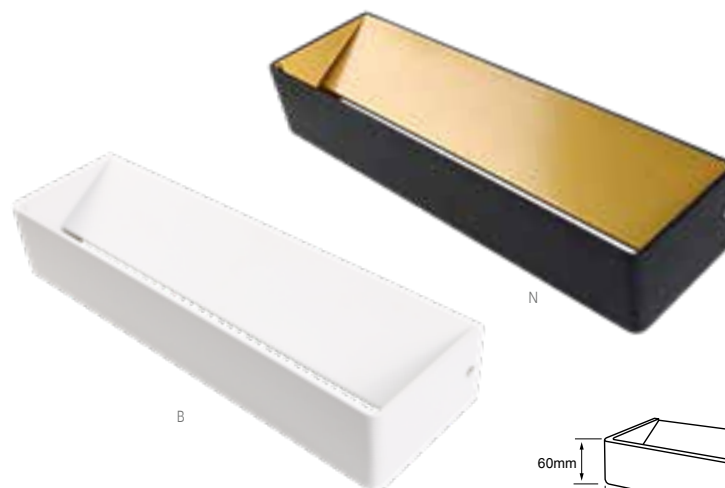

GRUIS
20TLLED408MV30B
Blanco

LUZ SUAVE CÁLIDA
● 3 000 K

Lumens: **1 100 lm**
Potencia: **20 W**
Volts: 100-240 V ~

20TLLED408MV30N
Negro / Oro

IRC: **80**
Vida útil: **30 000 h**
Ángulo: **155 °**
Tipo de lámpara: **LED (Integrado)**
Atenuable: **No**



TEXTURA DE LUZ

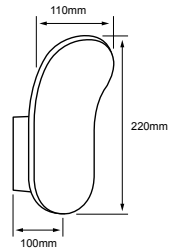

ALRAKIS
5TLLED1861MV30B

LUZ SUAVE CÁLIDA
● 3 000 K

Lumens: 318 lm
Potencia: 5 W
Volts: 100-240 V ~

Terminado: **Blanco**
IRC: **80**
Vida útil: **25 000 h**
Ángulo: **108 °**
Tipo de lámpara: **LED (Integrado)**
Atenuable: **No**

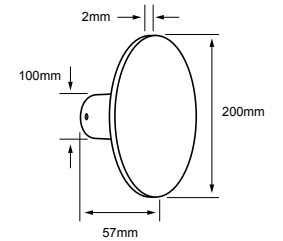

JUXTA I
10TLLED612MV30N

LUZ SUAVE CÁLIDA
● 3 000 K

Lumens: 690 lm
Potencia: 10 W
Volts: 100-240 V ~

Terminado: **Negro**
IRC: **80**
Vida útil: **15 000 h**
Ángulo: **100 °**
Tipo de lámpara: **LED (Integrado)**
Atenuable: **No**



TEXTURA DE LUZ

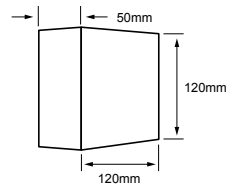

ALRESCHA
5TLLED615MV30TG

LUZ SUAVE CÁLIDA
● 3 000 K

Lumens: 318 lm
Potencia: 5 W
Volts: 100-240 V ~

Terminado: **Gris**
IRC: **80**
Vida útil: **25 000 h**
Ángulo: **193 °**
Tipo de lámpara: **LED (Integrado)**
Atenuable: **No**

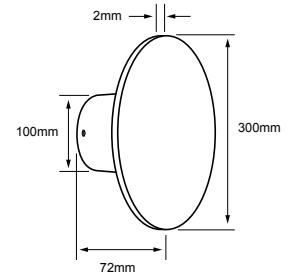

JUXTA II
15TLLED613MV30N

LUZ SUAVE CÁLIDA
● 3 000 K

Lumens: 1 300 lm
Potencia: 15 W
Volts: 100-240 V ~

Terminado: **Negro**
IRC: **80**
Vida útil: **15 000 h**
Ángulo: **100 °**
Tipo de lámpara: **LED (Integrado)**
Atenuable: **No**



TEXTURA DE LUZ

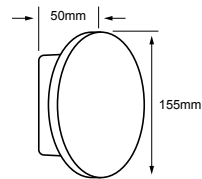

ALRUBA
5TLLED616MV30TG

LUZ SUAVE CÁLIDA
● 3 000 K

Lumens: 318 lm
Potencia: 5 W
Volts: 100-240 V ~

Terminado: **Gris**
IRC: **80**
Vida útil: **25 000 h**
Ángulo: **190 °**
Tipo de lámpara: **LED (Integrado)**
Atenuable: **No**

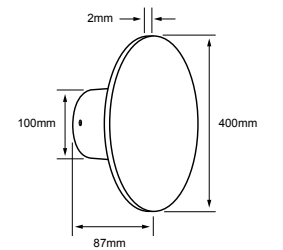

JUXTA III
20TLLED614MV30N

LUZ SUAVE CÁLIDA
● 3 000 K

Lumens: 1 500 lm
Potencia: 20 W
Volts: 100-240 V ~

Terminado: **Negro**
IRC: **80**
Vida útil: **15 000 h**
Ángulo: **100 °**
Tipo de lámpara: **LED (Integrado)**
Atenuable: **No**

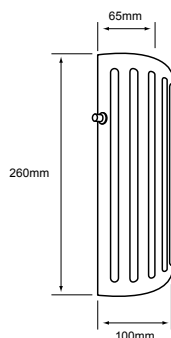

SHAM
7TLLED1853MV30OP

LUZ SUAVE CÁLIDA
● 3 000 K

Lumens: **399 lm**
Potencia: **7.5 W**
Volts: **100-240 V ~**

Terminado: **Opalino**
IRC: **80**
Vida útil: **15 000 h**
Ángulo: **169 °**
Tipo de lámpara: **LED (integrado)**
Atenuable: **No**

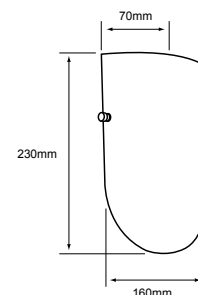

SHELIAC
8TLLED1856MV30OP

LUZ SUAVE CÁLIDA
● 3 000 K

Lumens: **390 lm**
Potencia: **8 W**
Volts: **100-240 V ~**

Terminado: **Opalino**
IRC: **80**
Vida útil: **15 000 h**
Ángulo: **153 °**
Tipo de lámpara: **LED (integrado)**
Atenuable: **No**

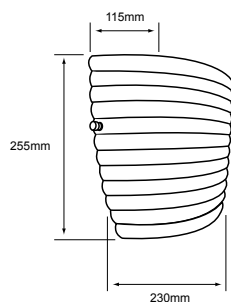

- Luminario decorativo de luz difusa.
- Terminado en blanco matte.
- Ideal para combinar con la iluminación general en espacios de interior.

SHERATAN
8TLLED1857MV30OP

LUZ SUAVE CÁLIDA
● 3 000 K

Lumens: **467 lm**
Potencia: **8 W**
Volts: **100-240 V ~**

Terminado: **Opalino**
IRC: **80**
Vida útil: **15 000 h**
Ángulo: **141 °**
Tipo de lámpara: **LED (integrado)**
Atenuable: **No**

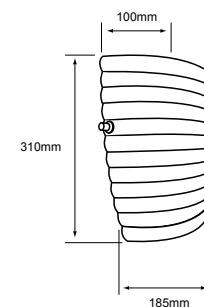

- Luminario decorativo de luz difusa.
- Terminado en blanco matte.
- Ideal para combinar con la iluminación general en espacios de interior.

SHERATAN II
8TLLED1858MV30OP

LUZ SUAVE CÁLIDA
● 3 000 K

Lumens: **511 lm**
Potencia: **8 W**
Volts: **100-240 V ~**

Terminado: **Opalino**
IRC: **80**
Vida útil: **15 000 h**
Ángulo: **155 °**
Tipo de lámpara: **LED (integrado)**
Atenuable: **No**



TEXTURA DE LUZ

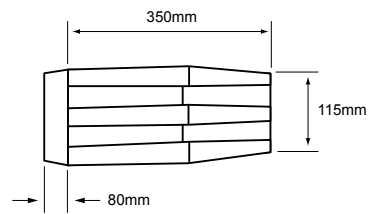

YILDUN
10TLLED2023MV30B

LUZ SUAVE CÁLIDA
● 3 000 K

Lumens: **334 lm**
Potencia: **10 W**
Volts: **100-240 V ~**

Terminado: **Blanco**
IRC: **80**
Vida útil: **15 000 h**
Ángulo: **172 °**
Tipo de lámpara: **LED (integrado)**
Atenuable: **No**



TEXTURA DE LUZ

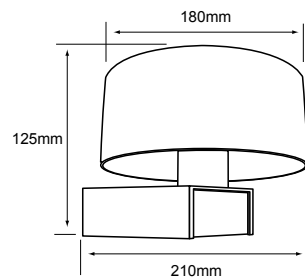

SKAT
10TLLED3515MV30B

LUZ SUAVE CÁLIDA
● 3 000 K

Lumens: **611 lm**
Potencia: **10 W**
Volts: **100-240 V ~**

Terminado: **Blanco**
IRC: **80**
Vida útil: **15 000 h**
Ángulo: **272 °**
Tipo de lámpara: **LED (integrado)**
Atenuable: **No**



TEXTURA DE LUZ

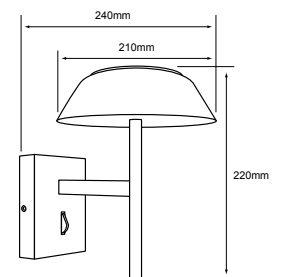

SUALOCIN
10TLLED3510MV30CR

LUZ SUAVE CÁLIDA
● 3 000 K

Lumens: **805 lm**
Potencia: **10 W**
Volts: **100-240 V ~**

Terminado: **Cromado**
IRC: **80**
Vida útil: **15 000 h**
Ángulo: **82 °**
Tipo de lámpara: **LED (integrado)**
Atenuable: **No**
Incluye apagador

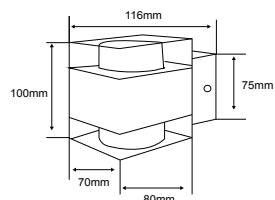

FONTANA
TLLED-500/6W/CR

LUZ SUAVE CÁLIDA
● 3 000 K

Lumens: **250 lm**
Potencia: **6 W**
Volts: 100-240 V ~

Terminado: **Cromado/Cristal**
IRC: **80**
Vida útil: **25 000 h**
Ángulo: **120 °**
Tipo de lámpara: **LED (Integrado)**
Atenuable: **No**

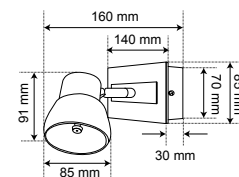

FREYRE I
TLLED-100/5W/30CR

LUZ SUAVE CÁLIDA
● 3 000 K

Lumens: **230 lm**
Potencia: **5 W**
Volts: 100-240 V ~

Terminado: **Cromado/Cristal Perlado**
IRC: **80**
Vida útil: **25 000 h**
Ángulo: **50 °**
Tipo de lámpara: **LED (Integrado)**
Atenuable: **No**

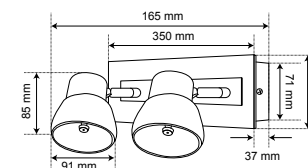

FREYRE II
TLLED-100/10W/30CR

LUZ SUAVE CÁLIDA
● 3 000 K

Lumens: **530 lm**
Potencia: **10 W**
Volts: 100-240 V ~

Terminado: **Cromado/Cristal Perlado**
IRC: **80**
Vida útil: **25 000 h**
Ángulo: **50 °**
Tipo de lámpara: **LED (Integrado)**
Atenuable: **No**

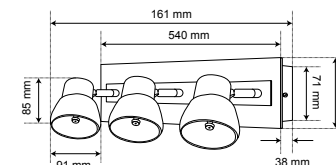

FREYRE III
TLLED-100/15W/30CR

LUZ SUAVE CÁLIDA
● 3 000 K

Lumens: **698 lm**
Potencia: **15 W**
Volts: 100-240 V ~

Terminado: **Cromado/Cristal Perlado**
IRC: **80**
Vida útil: **25 000 h**
Ángulo: **50 °**
Tipo de lámpara: **LED (Integrado)**
Atenuable: **No**

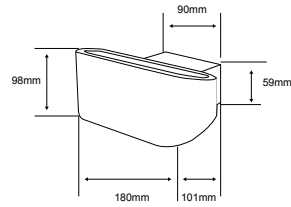

FUJIAN
TLLED-402/7W/30B

LUZ SUAVE CÁLIDA
● 3 000 K

Lumens: **450 lm**
Potencia: 7 W
Volts: 100-240 V ~

Terminado: **Blanco**
IRC: **80**
Vida útil: **25 000 h**
Ángulo: **132°**
Tipo de lámpara: **LED (Integrado)**
Atenuable: **No**

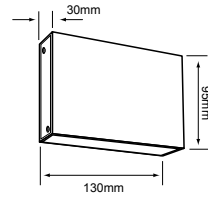

COLINA II
TLLED-119/S

LUZ SUAVE CÁLIDA
● 3 000 K

Lumens: **450 lm**
Potencia: 8 W
Volts: 100-240 V ~

Terminado: **Satinado**
IRC: **80**
Vida útil: **15 000 h**
Ángulo: **110°**
Tipo de lámpara: **LED (Integrado)**
Atenuable: **No**

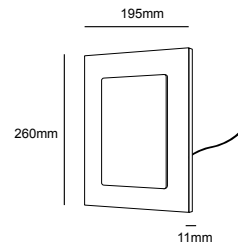

ABERDEEN
TLLED-600/B

LUZ SUAVE CÁLIDA
● 3 000 K

Lumens: **700 lm**
Potencia: 10 W
Volts: 100-127 V ~

Terminado: **Blanco**
IRC: **80**
Vida útil: **25 000 h**
Ángulo: **120°**
Tipo de lámpara: **LED (Integrado)**
Atenuable: **No**

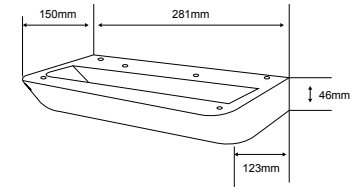

FUKU
TLLED-404/8W/30B

LUZ SUAVE CÁLIDA
● 3 000 K

Lumens: **450 lm**
Potencia: 8 W
Volts: 100-240 V ~

Terminado: **Blanco**
IRC: **80**
Vida útil: **25 000 h**
Tipo de lámpara: **LED (Integrado)**
Atenuable: **No**

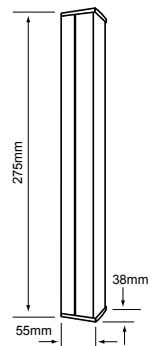

PORVOO
TLFLED-1010/S

LUZ BLANCA NEUTRA
○ 4 000 K

Lumens: **500 lm**
Potencia: 7 W
Volts: 100-240 V ~

Terminado: **Satinado**
IRC: **80**
Vida útil: **25 000 h**
Ángulo: **160°**
Tipo de lámpara: **LED (Integrado)**
Atenuable: **No**

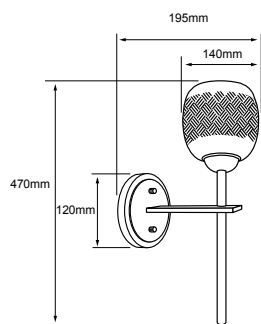

FULU IV
60TL8311MVN

Potencia máx.: 60 W
Volts: 100-240 V ~

Terminado: Negro
Tipo de base: E27
Tipo de lámpara: Opcional (No incluida)

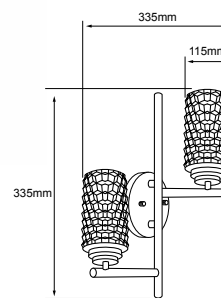

BERENICES II
120TL8512MVN

Potencia máx.: 120 W
Volts: 100-240 V ~

Terminado: Negro
Tipo de base: E27 x 2
Tipo de lámpara: Opcional (No incluida)

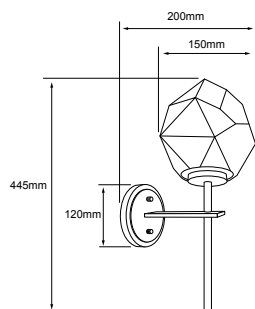

CASTULA III
60TL8611MVN

Potencia máx.: 60 W
Volts: 100-240 V ~

Terminado: Negro
Tipo de base: E14
Tipo de lámpara: Opcional (No incluida)

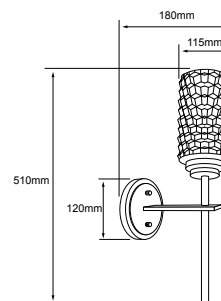

BERENICES III
60TL8511MVN

Potencia máx.: 60 W
Volts: 100-240 V ~

Terminado: Negro
Tipo de base: E27
Tipo de lámpara: Opcional (No incluida)



FULU VI
120TL8312MVN

Potencia máx.: 120 W
Volts: 100-240 V ~

Terminado: Negro
Tipo de base: E27 x 2
Tipo de lámpara: Opcional (No incluida)



FULU V
60TL8301MVN

Potencia máx.: 60 W
Volts: 100-240 V ~

Terminado: Negro
Tipo de base: E27
Tipo de lámpara: Opcional (No incluida)



DIADEM V
60TL8401MVN

Potencia máx.: 60 W
Volts: 100-240 V ~

Terminado: Negro
Tipo de base: E27
Tipo de lámpara: Opcional (No incluida)



DIADEM VI
60TL8411MVN

Potencia máx.: 60 W
Volts: 100-240 V ~

Terminado: Negro
Tipo de base: E27
Tipo de lámpara: Opcional (No incluida)



JUNHO
20TL9352MVB

Potencia máx.: 60 W
Volts: 100-240 V ~

Terminado: Cromado/Textil Blanco
Tipo de base: E27
Tipo de lámpara: Opcional (No incluida)
Posición ajustable

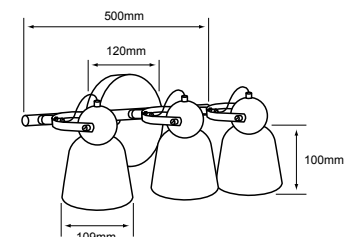

RAN III
180TL8003MVN

Potencia máx.: 180 W
Volts: 100-240 V ~

Terminado: Negro
Tipo de base: E27 x 3
Tipo de lámpara: Opcional (No incluida)



OKUL I
20TL9354MVB
Blanco

Potencia máx.: 60 W
Volts: 100-240 V ~

20TL9354MVN
Negro

Tipo de base: E27
Tipo de lámpara: Opcional (No incluida)
Longitud de cable ajustable

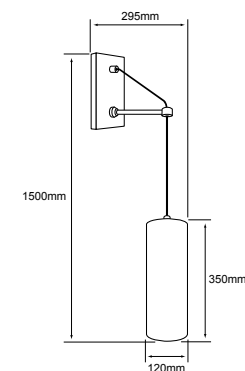

OKUL II
20TL9355MVB

Potencia máx.: 60 W
Volts: 100-240 V ~

Terminado: Cromado/Textil Blanco
Tipo de base: E27
Tipo de lámpara: Opcional (No incluida)
Longitud de cable ajustable

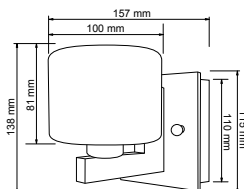

FILOS
60TL1820MVS

Potencia máx.: 40 W
Volts: 100-240 V ~ / 12 V ~

Terminado: Satinado/Cristal opalino
Tipo de base: G9
Tipo de lámpara: G9 (No incluida)

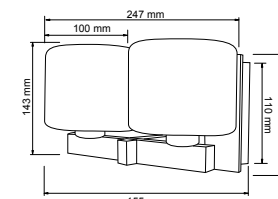

FILOS I
120TL1830MVS

Potencia máx.: 80 W
Volts: 100-240 V ~ / 12 V ~

Terminado: Satinado/Cristal opalino
Tipo de base: G9 x 2
Tipo de lámpara: G9 x 2 (No incluida)

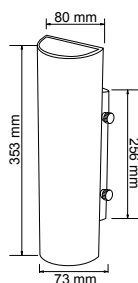

FERRATA
120TL1805MVOP

Potencia máx.: 50 W
Volts: 100-240 V ~ / 12 V ~

Terminado: Cristal opalino
Tipo de base: G9 x 2
Tipo de lámpara: G9 x 2 (No incluida)

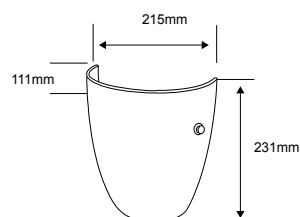

FOGGIA
TL-1855/S

Potencia máx.: 60 W
Volts: 100-240 V ~

Terminado: Cristal opalino
Tipo de base: E27
Tipo de lámpara: Opcional (No incluida)

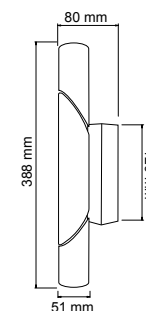

GOIANIA
120TL1850MVS

Potencia máx.: 80 W
Volts: 100-240 V ~ / 12 V ~

Terminado: Cromado/Cristal Opalino
Tipo de base: G9 x 2
Tipo de lámpara: G9 x 2 (No incluida)

Lámparas a 12 V requiere transformador.

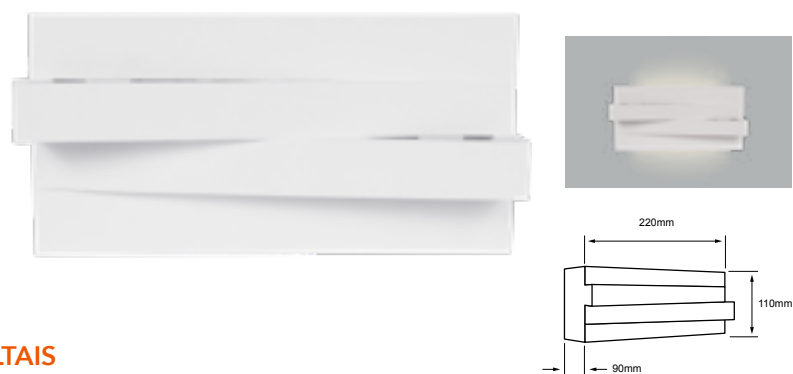

ALTAIS
80TL2024MVB

Potencia máx.: 80 W
Volts: 100-240 V ~

Terminado: Blanco
Tipo de base: G9 x 2
Tipo de lámpara: 2 x G9 (No incluida)

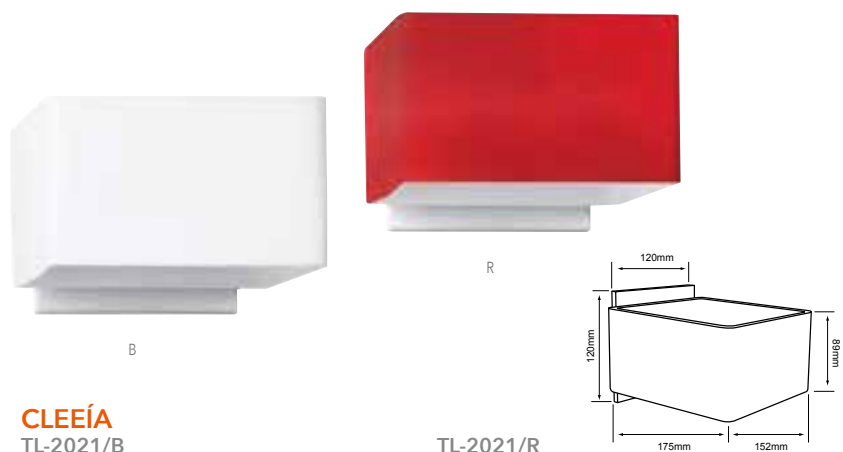

CLEEÍA
TL-2021/B
Cristal Blanco

Potencia máx.: 40 W
Volts: 100-240 V ~ / 12 V ~

TL-2021/R
Cristal Rojo

Tipo de base: G9
Tipo de lámpara: G9 (No incluida)

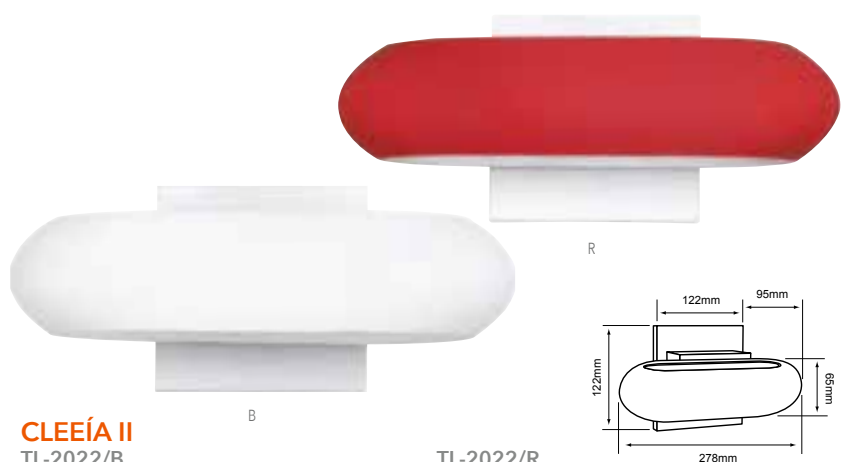

CLEEÍA II
TL-2022/B
Cristal Blanco

Potencia: 40 W
Volts: 100-240 V ~ / 12 V ~

TL-2022/R
Cristal Rojo

Tipo de base: G9
Tipo de lámpara: G9 (No incluida)



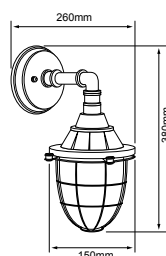

POLARIS I
60TL1418MVN

Potencia máx.: 60 W
Volts: 100-240 V ~

Terminado: Negro
Tipo de base: E27
Tipo de lámpara: Opcional (No incluida)

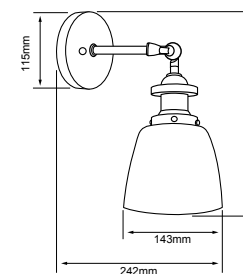

MAIA I
20TL342MVCT

Potencia: 60 W
Volts: 100-240 V ~

Terminado: Cristal Transparente
Tipo de base: E27
Tipo de lámpara: Opcional (No incluida)

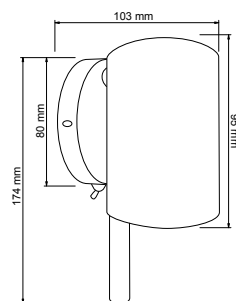

GIARRE
60LVC202MVOP

Potencia máx.: 40 W
Volts: 100-240 V ~ / 12 V ~

Terminado: Satinado/Cristal opalino
Tipo de base: G9
Tipo de lámpara: G9 (No incluida)

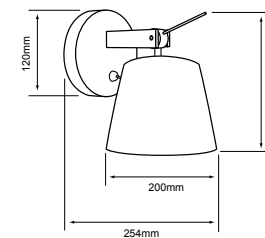

SIRRAH
TL-9351/B

Potencia máx.: 60 W
Volts: 100-240 V ~

Terminado: Cromado/Textil Blanco
Tipo de base: E27
Tipo de lámpara: Opcional (No incluida)

Lámparas a 12 V requiere transformador.

*Tecnolite se reserva el derecho de modificar la información sin previo aviso y no se hace responsable por errores u omisiones en este documento.
*Lámparas y luminarios no aptos para trabajo de voltaje constante en niveles superiores o inferiores marcados en el producto.

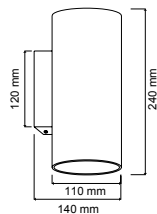

FEZ
60TL1890MVOP

Potencia máx.: 40 W
Volts: 100-240 V ~

Terminado: Cristal opalino
Tipo de base: G9
Tipo de lámpara: G9 (No incluida)

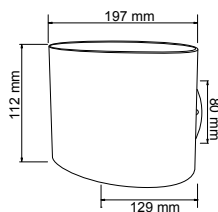

FLORENCIA
60TL1807MVOP

Potencia máx.: 40 W
Volts: 100-240 V ~

Terminado: Cristal opalino
Tipo de base: G9
Tipo de lámpara: G9 (No incluida)

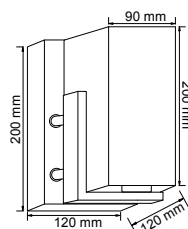

GINEBRA
TL-2028/S

Potencia máx.: 60 W
Volts: 100-240 V ~

Terminado: Cristal opalino
Tipo de base: E27
Tipo de lámpara: Opcional (No incluida)

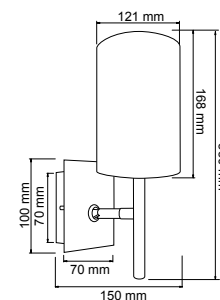

GIRONA
60TL3500MVS

Potencia máx.: 60 W
Volts: 100-240 V ~

Terminado: Textil blanco
Tipo de base: E27
Tipo de lámpara: Opcional (No incluida)

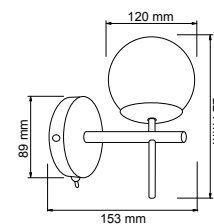

GRESSAN
TL-4000/S

Potencia máx.: 40 W
Volts: 100-240 V ~ / 12 V ~

Terminado: Cristal opalino
Tipo de base: G9
Tipo de lámpara: G9 (No incluida)

Lámparas a 12 V requiere transformador.

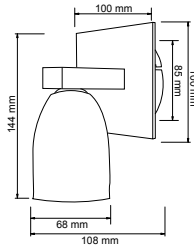

MELSI
3TL1101MVS

Potencia máx.: 40 W
Volts: 100-240 V ~

Terminado: Satinado/Cristal Opalino
Tipo de base: G9
Tipo de lámpara: G9 (No incluida)

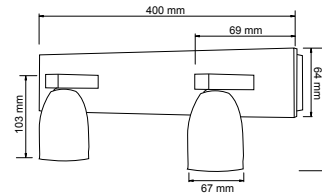

MELSI
6TL1102MVS

Potencia máx.: 80 W
Volts: 100-240 V ~

Terminado: Satinado/Cristal Opalino
Tipo de base: G9 x 2
Tipo de lámpara: G9 x 2 (No incluida)

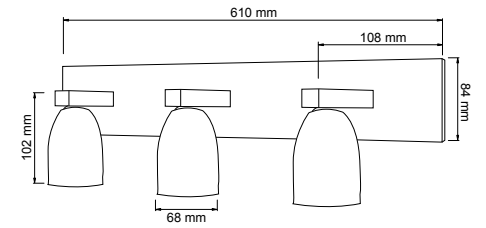

MELSI
09TL1103MVS

Potencia máx.: 120 W
Volts: 100-240 V ~

Terminado: Satinado/Cristal Opalino
Tipo de base: G9 X 3
Tipo de lámpara: G9 x 3 (No incluida)



C



S

TL-6150/S
Satinado

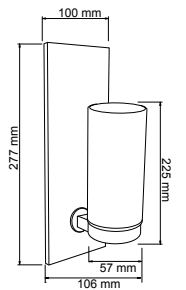

MESSINA
TL-6150/C
Cristal

Potencia máx.: 40 W
Volts: 100-240 V ~ / 12 V ~

Tipo de base: G9
Tipo de lámpara: G9 (No incluida)

Lámparas a 12 V requiere transformador.



S



Z

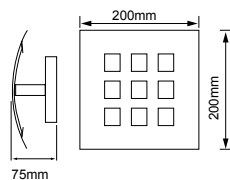

FORTE
60TL6050MVS
Satinado

60TL6050MVZ
Zinc

Potencia máx.: 40 W
Volts: 100-240 V ~ / 12 V ~

Terminado: Satinado
Tipo de base: G9
Tipo de lámpara: G9 (No incluida)



S

Z

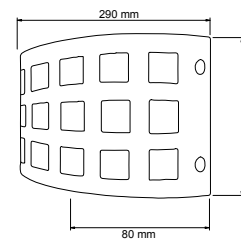

FORZA
60TL6055MVS
Satinado

60TL6055MVZ
Zinc

Potencia máx.: 60 W
Volts: 100-240 V ~

Terminado: Satinado
Tipo de base: E27
Tipo de lámpara: Opcional (No incluida)

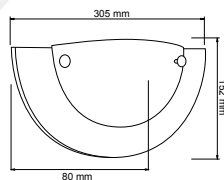

FORIO I
TL-2010/B

Potencia máx.: 60 W
Volts: 100-240 V ~

Terminado: Blanco/ Opalino
Tipo de base: E27
Tipo de lámpara: Opcional (No incluida)



FORLI I
TL-5025/M

Potencia máx.: 60 W
Volts: 100-240 V ~

Terminado: Madera oscura / Opalino
Tipo de base: E27
Tipo de lámpara: Opcional (No incluida)

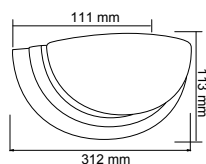

FRANCFORT
TL-1900/S

Potencia máx.: 60 W
Volts: 100-240 V ~

Terminado: Satinado/Cristal opalino
Tipo de base: E27
Tipo de lámpara: Opcional (No incluida)

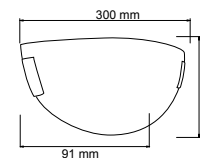

MARE I
60TL8520MVS

Potencia máx.: 60 W
Volts: 100-240 V ~

Terminado: Cristal perlado
Tipo de base: E27
Tipo de lámpara: Opcional (No incluida)

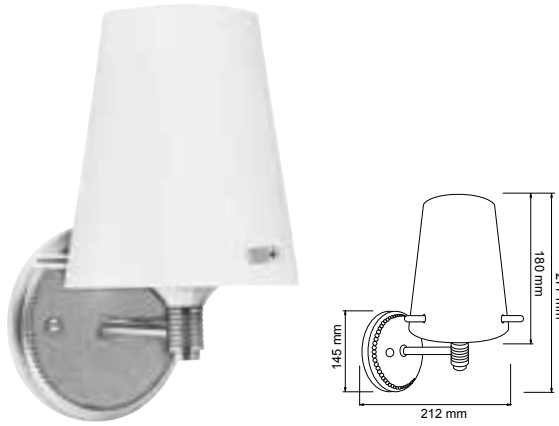

GENZANO
TL-9350/S

Potencia máx.: 60 W
Volts: 100-240 V ~

Terminado: **Cristal opalino**
Tipo de base: **E27**
Tipo de lámpara: **Opcional (No incluida)**



GENOVA
60TL1860MVAM
Cristal Ámbar

Potencia máx.: 60 W
Volts: 100-240 V ~

60TL1860MVOP
Cristal opalino

Tipo de base: **E27**
Tipo de lámpara: **Opcional (No incluida)**

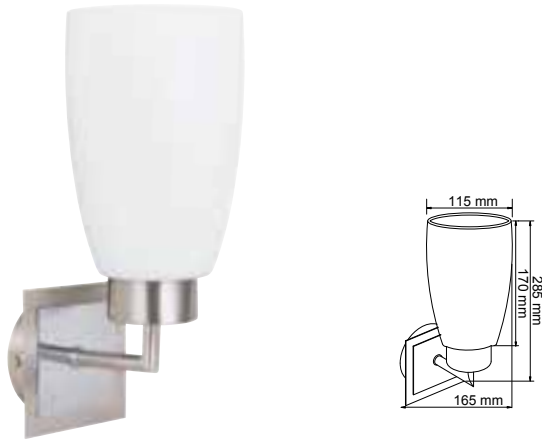

GIBRALTAR
60TL1875MVOP

Potencia máx.: 60 W
Volts: 100-240 V ~

Terminado: **Cristal opalino**
Tipo de base: **E27**
Tipo de lámpara: **Opcional (No incluida)**

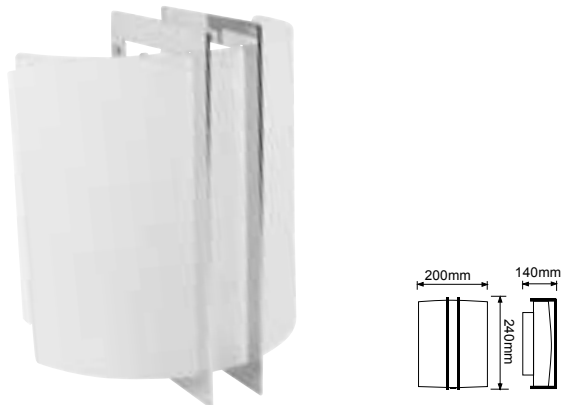

FIRENZE
60TL1770MVS

Potencia máx.: 60 W
Volts: 100-240 V ~

Terminado: **Cristal perlado**
Tipo de base: **E27**
Tipo de lámpara: **Opcional (No incluida)**

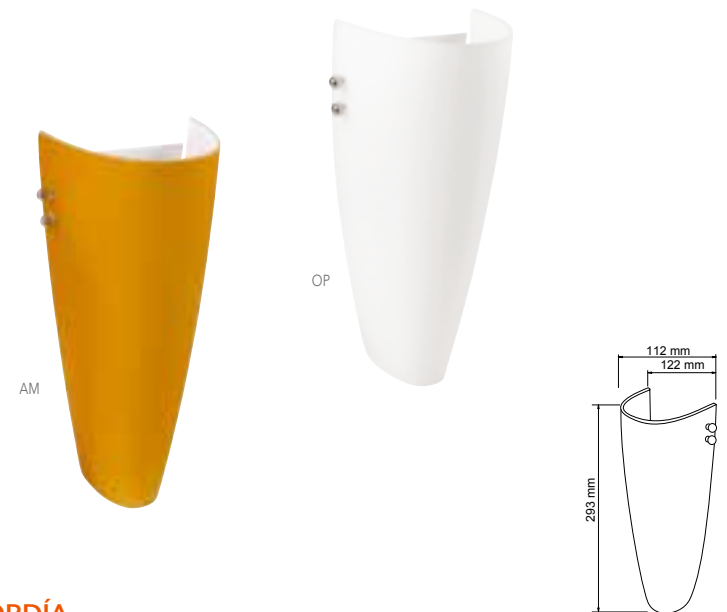

CONCORDIA
60TL6020MVAM
Cristal Ámbar

Potencia máx.: 60 W
Volts: 100-240 V ~

60TL6020MVOP
Cristal opalino

Tipo de base: **E27**
Tipo de lámpara: **Opcional (No incluida)**



COMERCIAL ^{INTERIOR}

RENUÉVATE Y DALE A TU NEGOCIO
NUEVAS ATMÓSFERAS CON ILUMINACIÓN

tecnolite®
LA LUZ ES TUYA



SASSICAIA

BOLGHERI

ITALIA

2008

Contiene
6 bottiglie da lit. 0,750

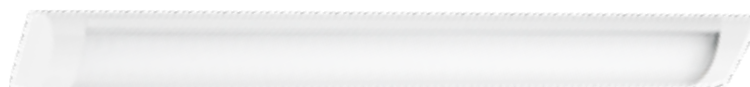

CAPELA I

18FLCPLED40MVS
LUZ BLANCA NEUTRA
○ 4 000 K

Lumens: **1 620 lm**
Potencia: **18 W**
Volts: **100-240 V ~**

18FLCPLED65MVS

LUZ DE DÍA
● 6 500 K

Terminado: **Blanco**
IRC: **80**
Vida útil: **25 000 h**
Ángulo: **120 °**
Tipo de lámpara: **LED (Integrado)**
Atenuable: **No**

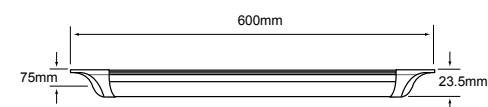

CAPELLA III

36FLCPLED40MVS
LUZ BLANCA NEUTRA
○ 4 000 K

Lumens: **3 240 lm**
Potencia: **36 W**
Volts: **100-240 V ~**

36FLCPLED65MVS

LUZ DE DÍA
● 6 500 K

Terminado: **Blanco**
IRC: **80**
Vida útil: **25 000 h**
Ángulo: **120 °**
Tipo de lámpara: **LED (Integrado)**
Atenuable: **No**

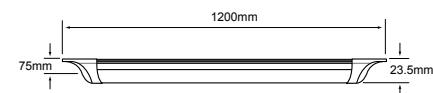



AMPUS
FLCP-LED/003/B
 LUZ BLANCA NEUTRA
 ○ 4 000 K

Lumens: **3 600 lm**
 Potencia: **36 W**
 Volts: **100-240 V ~**

FLCP-LED/003/65/B
 LUZ DE DÍA
 ○ 6 500 K

Terminado: **Blanco**
 IRC: **80**
 Vida útil: **25 000 h**
 Ángulo: **120 °**
 Tipo de lámpara: **LED (Integrado)**
 Atenuable: **No**

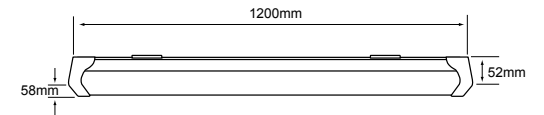

CAPELLA
FLCP-LED/002/B
 LUZ BLANCA NEUTRA
 ○ 4 000 K

Lumens: **4 000 lm**
 Potencia: **40 W**
 Volts: **100-240 V ~**

FLCP-LED/002/65/B
 LUZ DE DÍA
 ○ 6 500 K

Terminado: **Blanco**
 IRC: **80**
 Vida útil: **25 000 h**
 Ángulo: **120 °**
 Tipo de lámpara: **LED (Integrado)**
 Atenuable: **No**

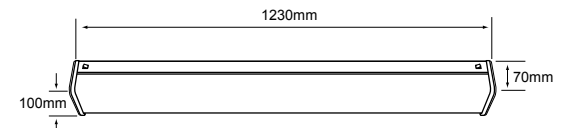

ZION
FLCP-LED/001/S

LUZ BLANCA NEUTRA
 ○ 4 000 K

Lumens: **3 500 lm**
 Potencia: **35 W**
 Volts: **100-240 V ~**

Terminado: **Satinado**
 IRC: **80**
 Vida útil: **25 000 h**
 Ángulo: **120 °**
 Tipo de lámpara: **LED (Integrado)**
 Atenuable: **No**

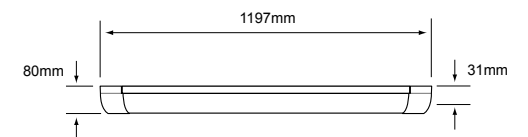



STEP CCT

RUBIDEA I 4FLCLED01MVCCTB

TEMPERATURA DE COLOR AJUSTABLE
●●● 3 000 K - 4 100 K - 6 500 K

Lumens: **350 lm**
Potencia: **4 W**
Volts: **100-240 V ~**

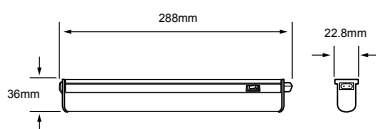

Aplicación: **Techo / Pared**
Terminado: **Blanco**
IRC: **80**
Vida útil: **25 000 h**
Ángulo: **120 °**
Tipo de lámpara: **LED (Integrado)**
Atenuable: **No**
Cambio de color de temperatura con apagador



STEP CCT

RUBIDEA II 7FLCLED02MVCCTB

TEMPERATURA DE COLOR AJUSTABLE
●●● 3 000 K - 4 100 K - 6 500 K

Lumens: **650 lm**
Potencia: **7 W**
Volts: **100-240 V ~**

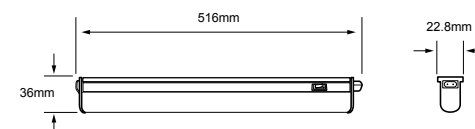

Aplicación: **Techo / Pared**
Terminado: **Blanco**
IRC: **80**
Vida útil: **25 000 h**
Ángulo: **120 °**
Tipo de lámpara: **LED (Integrado)**
Atenuable: **No**
Cambio de color de temperatura con apagador



STEP CCT

RUBIDEA III 14FLCLED03MVCCTB

TEMPERATURA DE COLOR AJUSTABLE
●●● 3 000 K - 4 100 K - 6 500 K

Lumens: **1 300 lm**
Potencia: **14 W**
Volts: **100-240 V ~**

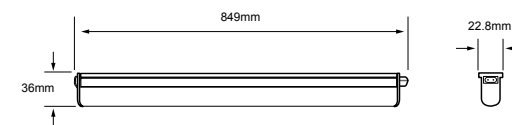

Aplicación: **Techo / Pared**
Terminado: **Blanco**
IRC: **80**
Vida útil: **25 000 h**
Ángulo: **120 °**
Tipo de lámpara: **LED (Integrado)**
Atenuable: **No**
Cambio de color de temperatura con apagador



STEP CCT

RUBIDEA IV 18FLCLED04MVCCTB

TEMPERATURA DE COLOR AJUSTABLE
●●● 3 000 K - 4 100 K - 6 500 K

Lumens: **1 750 lm**
Potencia: **18 W**
Volts: **100-240 V ~**

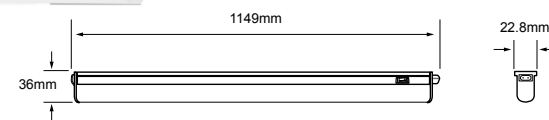

Aplicación: **Techo / Pared**
Terminado: **Blanco**
IRC: **80**
Vida útil: **25 000 h**
Ángulo: **120 °**
Tipo de lámpara: **LED (Integrado)**
Atenuable: **No**
Cambio de color de temperatura con apagador

PEKIN V
FLCLED-01/4W/40

LUZ BLANCA NEUTRA
○ 4 000 K

Lumens: **420 lm**
Potencia: **4 W**
Volts: **100-240 V ~**

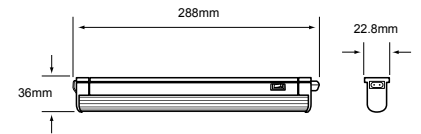

Aplicación: **Techo / Pared**
Terminado: **Blanco**
IRC: **80**
Vida útil: **25 000 h**
Ángulo: **120 °**
Tipo de lámpara: **LED (Integrado)**
Atenuable: **No**

PEKIN VI
FLCLED-02/7W/40

LUZ BLANCA NEUTRA
○ 4 000 K

Lumens: **700 lm**
Potencia: **7 W**
Volts: **100-240 V ~**

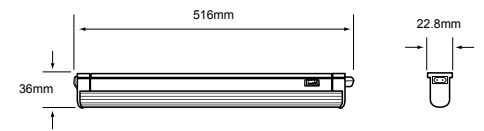
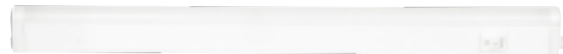

Aplicación: **Techo / Pared**
Terminado: **Blanco**
IRC: **80**
Vida útil: **25 000 h**
Ángulo: **120 °**
Tipo de lámpara: **LED (Integrado)**
Atenuable: **No**

PEKIN VII
FLCLED-03/14W/40

LUZ BLANCA NEUTRA
○ 4 000 K

Lumens: **1 350 lm**
Potencia: **14 W**
Volts: **100-240 V ~**

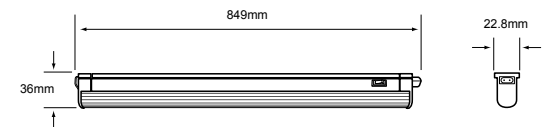
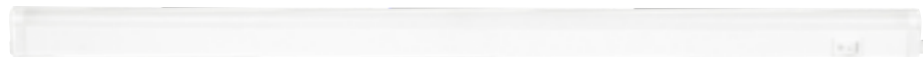

Aplicación: **Techo / Pared**
Terminado: **Blanco**
IRC: **80**
Vida útil: **25 000 h**
Ángulo: **120 °**
Tipo de lámpara: **LED (Integrado)**
Atenuable: **No**

PEKIN VIII
FLCLED-04/20W/40

LUZ BLANCA NEUTRA
○ 4 000 K

Lumens: **1 850 lm**
Potencia: **20 W**
Volts: **100-240 V ~**

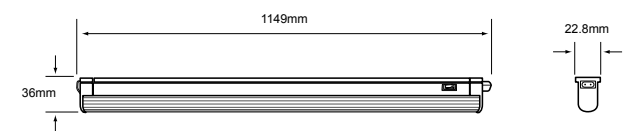

Aplicación: **Techo / Pared**
Terminado: **Blanco**
IRC: **80**
Vida útil: **25 000 h**
Ángulo: **120 °**
Tipo de lámpara: **LED (Integrado)**
Atenuable: **No**

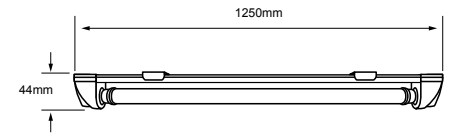

THUBAN

16FLCLEDT8V65B

LUZ DE DÍA
 ● 6 500 K

Lumens: **1 600 lm**
 Potencia: 16 W
 Volts: 127 V ~

Terminado: **Blanco**
 IRC: **70**
 Vida útil: **15 000 h**
 Ángulo: **170 °**
 Tipo de lámpara: **LED (integrado)**
 Atenuable: **No**
 Base: **G13**
 Incluye: **Tubo LED T8 16W**

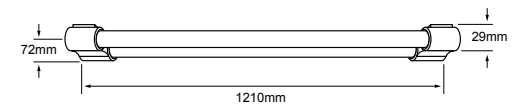

NUEVO

THUBAN II

36FLCLEDT8DMV65B

LUZ DE DÍA
 ● 6 500 K

Lumens: **3 240 lm**
 Potencia: 36 W
 Volts: 100-277 V ~

Terminado: **Blanco**
 IRC: **80**
 Vida útil: **25 000 h**
 Ángulo: **360 °**
 Tipo de lámpara: **LED (integrado)**
 Atenuable: **No**
 IP: **20**

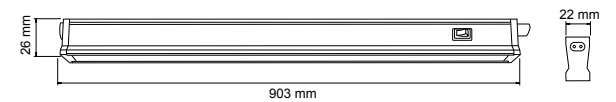

PALIKIR I
FLCLED-11/11W/40

LUZ BLANCA NEUTRA
○ 4 000 K

Lumens: **950 lm**
Potencia: 11 W
Volts: 100-240 V ~

Aplicación: Techo / Pared
Terminado: Gris
IRC: 80
Vida útil: **25 000 h**
Ángulo: 120 °
Tipo de lámpara: LED (Integrado)
Atenuable: No

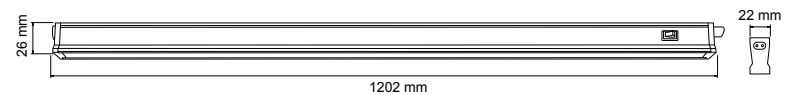

PALIKIR II
FLCLED-11/17W/40

LUZ BLANCA NEUTRA
○ 4 000 K

Lumens: **1450 lm**
Potencia: 17 W
Volts: 100-240 V ~

Aplicación: Techo / Pared
Terminado: Gris
IRC: 80
Vida útil: **25 000 h**
Ángulo: 120 °
Tipo de lámpara: LED (Integrado)
Atenuable: No

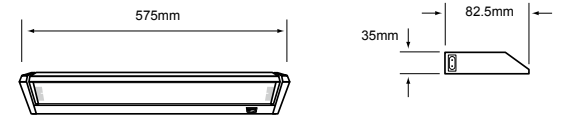

PORTOFINO

FLCDLED-060/40

LUZ BLANCA NEUTRA
○ 4 000 K

Lumens: **800 lm**
Potencia: **10 W**
Volts: **100-240 V ~**

Terminado: **Satinado**
IRC: **80**
Vida útil: **25 000 h**
Ángulo: **120 °**
Tipo de lámpara: **LED (Integrado)**
Atenuable: **No**

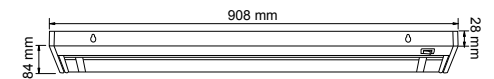

PORTOFINO II

FLCDLED-12W/40/S

LUZ BLANCA NEUTRA
○ 4 000 K

Lumens: **950 lm**
Potencia: **12 W**
Volts: **100-240 V ~**

Terminado: **Satinado**
IRC: **80**
Vida útil: **25 000 h**
Ángulo: **120 °**
Tipo de lámpara: **LED (Integrado)**
Atenuable: **No**



INTERCONECTABLE

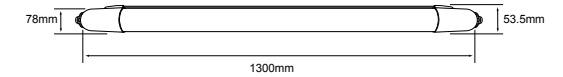

HYDRA
40ESTLED65MVS
 LUZ DE DÍA
 ○ 6 500 K
 Lumens: **5 400 lm**

Potencia: 40 W
 Volts: 100-240 V ~

Aplicación: A prueba de vapor
 Terminado: **Satinado**
 IRC: 80
 Vida útil: **30 000 h**

Ángulo: 140°
 IP: 66
 Tipo de lámpara: LED (Integrado)
 Atenuable: **No**
 Interconectable



OPORTO III
18ESTLED236MV40G
 LUZ BLANCA NEUTRA
 ○ 4 000 K

Lumens: **1 600 lm**
 Potencia: 18 W
 Volts: 100 - 277 V ~

18ESTLED236MV65G
 LUZ DE DÍA
 ○ 6 500 K

Terminado: Gris
 IRC: 70
 Vida útil: **20 000 h**
 Ángulo: 210°
 IP: 65
 Tipo de base: G13
 Tipo de lámpara: LED (integrado)
 Atenuable: **No**

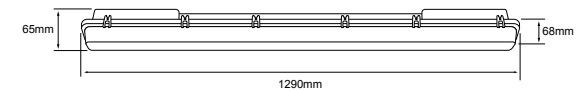

OPORTO IV
36ESTLED236MV40G
 LUZ BLANCA NEUTRA
 ○ 4 000 K

Lumens: **2 800 lm**
 Potencia: 36 W
 Volts: 100 - 277 V ~

36ESTLED236MV65G
 LUZ DE DÍA
 ○ 6 500 K

Terminado: Gris
 IRC: 70
 Vida útil: **20 000 h**
 Ángulo: 210°
 IP: 65
 Tipo de base: G13 x 2
 Tipo de lámpara: LED (integrado)
 Atenuable: **No**

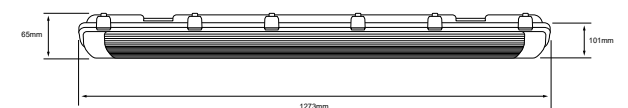



OPORTO II
32ESTLED232V40S
 LUZ BLANCA NEUTRA
 ○ 4 000 K

Lumens: **2 800 lm**
 Potencia: **32 W**
 Volts: **127 V ~**

32ESTLED232V65S
 LUZ DE DÍA
 ○ 6 500 K

Aplicación: **A prueba de vapor**
 Terminado: **Gris**
 IRC: **80**
 Vida útil: **15 000 h**

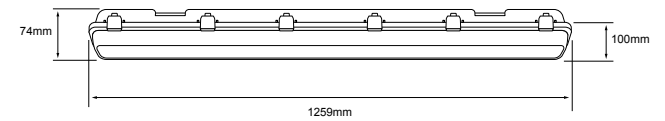

Ángulo: **80 °**
 IP: **65**
 Tipo de base: **G5 x 2**
 Tipo de lámpara: **LED (Integrado)**
 Atenuable: **No**



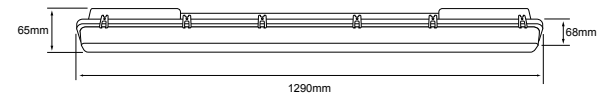

OPORTO V
60EST236SLG

Potencia máx: 60 W
Volts: 100 - 277 V ~

Terminado: Gris
Tipo de base: G13
Tipo de lámpara: **Tubo T8 (No incluido)**
IP: 65
Lámpara recomendada 18T8LED120MV40C

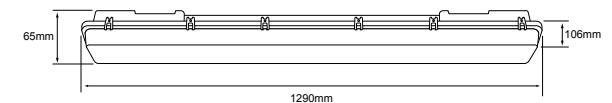

 CONEXIÓN PARALELA INDEPENDIENTE

 AMPLIO RANGO DE VOLTAJE
100 - 277 V

 **NO INCLUYE LÁMPARA**
ELIGE EL TIPO DE
TEMPERATURA Y
POTENCIA
CONFIGURA A TU GUSTO

OPORTO VI
120EST236SLG

Potencia máx: 120 W
Volts: 100 - 277 V ~

Terminado: Gris
Tipo de base: G13 x 2
Tipo de lámpara: **Tubo T8 (No incluido)**
IP: 65
Lámpara recomendada 18T8LED120MV40C



INTERIOR
OFICINA

**TRANSFORMA TU ESPACIO DE TRABAJO
CON LUZ FUNCIONAL DE NUEVA GENERACIÓN**



tecnolite[®]
LA LUZ ES TUYA



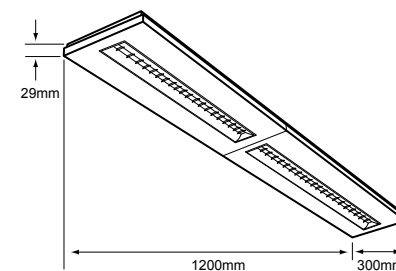

DANIOS II
LTLLED-2230/40/B

LUZ BLANCA NEUTRA
○ 4 000 K

Lumens: **3 300 lm**
Potencia: 30 W
Volts: 100-240 V ~

Aplicación: **Suspendido / Empotrado**
Terminado: **Blanco**
IRC: **80**
Vida útil: **40 000 h**
Ángulo: **80°**
Tipo de lámpara: **LED (Integrado)**
Corte de empotramiento: **1170 mm x 270 mm**
Atenuable: **No**



APAGADO / ENCENDIDO

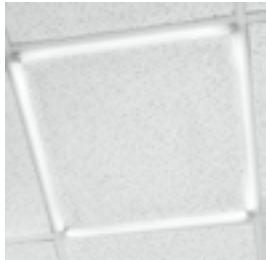

- Ligero
- Buen flujo luminoso
- Se queda en plafón

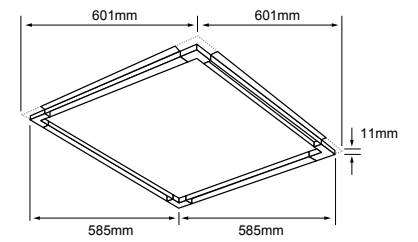

TARF

40FRLED601MV40B
LUZ BLANCA NEUTRA
○ 4 000 K

Lumens: **3 000 lm**
Potencia: 40 W
Volts: 100-240 V ~

40FRLED601MV65B
LUZ DE DÍA
○ 6 500 K

Terminado: Blanco
IRC: 80
Vida útil: **25 000 h**
Ángulo: 120 °
Tipo de lámpara: LED (integrado)
Atenuable: No

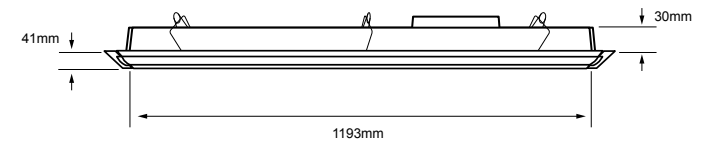
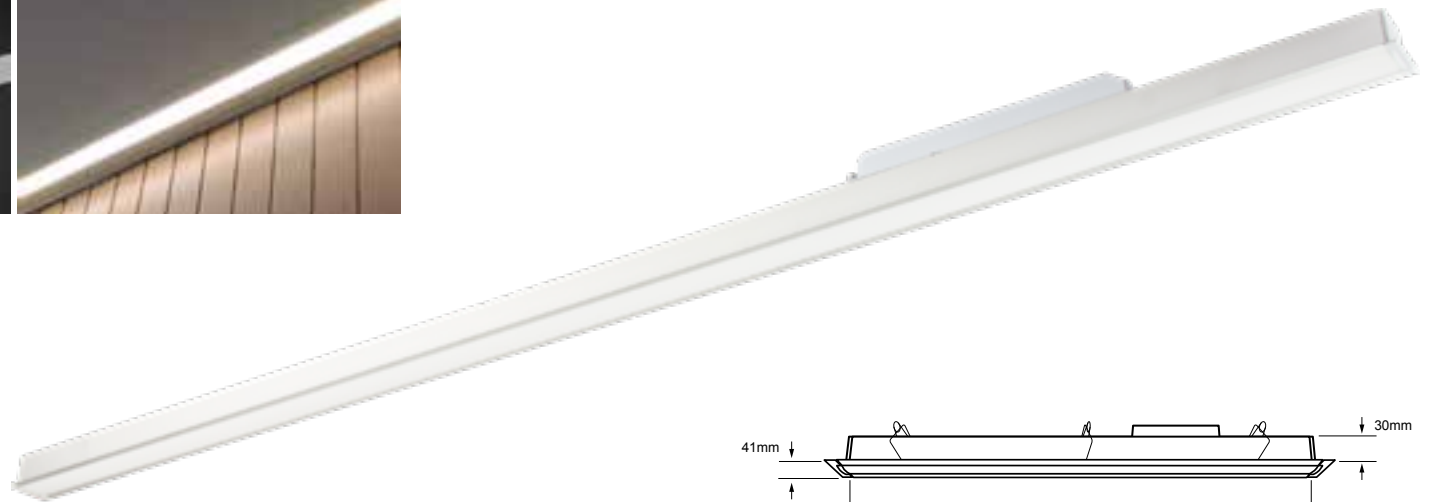
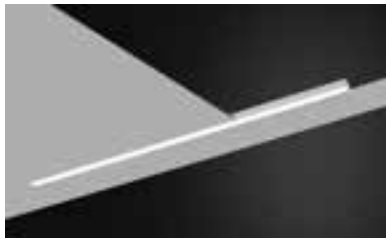

- Elegante
- Estético
- Luz de soporte



HYGIEA
20PERLED120MV40S

LUZ BLANCA NEUTRA
○ 4 000 K

Lumens: **1 100 lm**
Potencia: 20 W
Volts: 100-240 V ~

Terminado: Satin
IRC: 80
Vida útil: **30 000 h**
Ángulo: 120 °
Tipo de lámpara: LED (Integrado)
Corte de empotramiento: 1185 mm x 35 mm
Atenuable: No



AZMIDI II
40DPANLED40MVB
LUZ BLANCA NEUTRA
○ 4 000 K

Lumens: **3 000 lm**
Potencia: **40 W**
Volts: **127 V ~**

Terminado: **Blanco**
IRC: **80**
Vida útil: **30 000 h**
Ángulo: **120 °**
Tipo de lámpara: **LED (Integrado)**

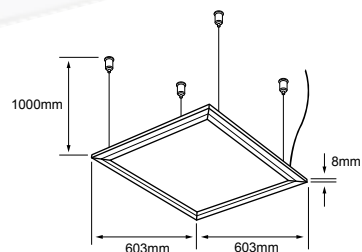

40DPANLED65MVB
LUZ DE DÍA
● 6 500 K

Incluye: **Driver LED**
Atenuable: **Sí**
Equipo para suspensión disponible,
No incluido



DOMUS IV
40PANLED40MVB
LUZ BLANCA NEUTRA
○ 4 000 K

Lumens: **3 000 lm**
Potencia: **40 W**
Volts: **100-240 V ~**

Aplicación: **Suspendido / Empotrado**
Terminado: **Blanco**
IRC: **70**
Vida útil: **25 000 h**
Ángulo: **120 °**

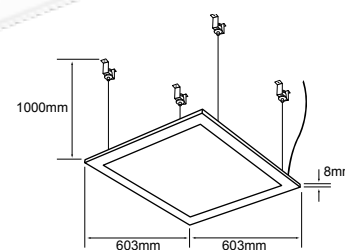

40PANLED65MVB
LUZ DE DÍA
● 6 500 K

Tipo de lámpara: **LED (Integrado)**
Corte de empotramiento: **585 mm x 585 mm**
Atenuable: **No**
Equipo para suspensión disponible,
No incluido



DOMUS I
PAN-LED/40/40/S
LUZ BLANCA NEUTRA
○ 4 000 K

Lumens: **3 500 lm**
Potencia: **40 W**
Volts: **100-240 V ~**

Aplicación: **Suspendido / Empotrado**
Terminado: **Satinado**
IRC: **80**
Vida útil: **25 000 h**

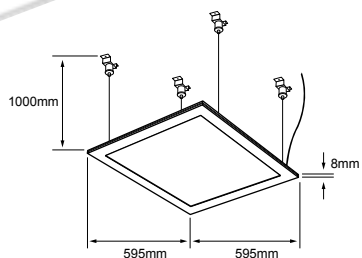

PAN-LED/40/65/S
LUZ DE DÍA
● 6 500 K

Ángulo: **120 °**
Tipo de lámpara: **LED (Integrado)**
Atenuable: **No**
Incluye equipo para suspender



ACCESORIO
A40PANLEDMVS

Terminado: **Satinado**
Accesorio de suspensión

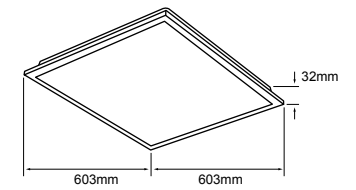

ACRUX
40BKLED40MVB
 LUZ BLANCA NEUTRA
 ○ 4 000 K

Lumens: **3 800 lm**
 Potencia: **40 W**
 Volts: **100-240 V ~**

Terminado: **Blanco**
 IRC: **80**
 Vida útil: **30 000 h**
 Ángulo: **120 °**

40BKLED65MVB
 LUZ DE DÍA
 ○ 6 500 K

Tipo de lámpara: **LED (Integrado)**
 Incluye: **Driver LED**
 Corte de empotramiento: **595 mm x 595 mm**
 Atenuable: **No**

40BKLED40MVB
40BKLED65MVB (back light)



Se llama "Back Light" porque la disposición interna de los LEDs se encuentran en la base del panel, a diferencia de los paneles comunes que se encuentran en el perímetro del luminario. Ofreciendo una mejora en iluminación.



Luminario con 32 mm de profundidad para la distribución de los LEDs, panel de 603x603 mm.



Es muy ligero.



Instalación: empotrado, exclusivo para plafón reticulado.



Flujo: 3800 lúmens.



TC: luz neutra 4000K / luz de día 6500K



Vida útil: 30 000 hrs.

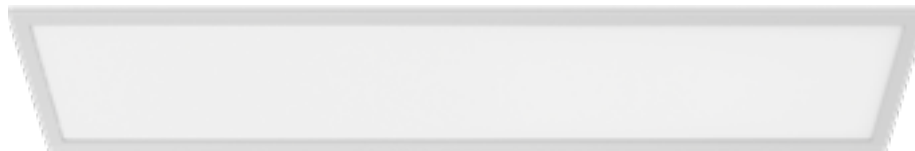

**DOMUS II**

PAN-LED-L/45/40/S
LUZ BLANCA NEUTRA
○ 4 000 K

45PANLEDL65MVS
LUZ DE DÍA
● 6 500 K



SU TAMAÑO Y DISEÑO
PERMITE CREAR **AMBIENTES
DECORATIVOS**



**MAYOR AHORRO
ENERGÉTICO**



DISTRIBUCIÓN
LUMÍNICA
HOMOGÉNEA



**ALTO
FLUJO LUMINOSO**

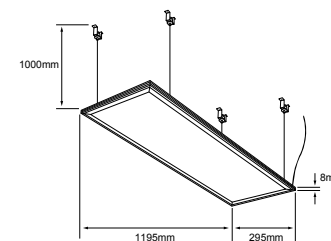

Lumens: **3 600 lm**
Potencia: **45 W**
Volts: **100-240 V ~**

Aplicación: **Suspendido / Empotrado**
Terminado: **Satinado**
IRC: **80**
Vida útil: **25 000 h**
Ángulo: **110 °**

Tipo de lámpara: **LED (Integrado)**
Corte de empotramiento: **1170 mm x 270 mm**
Atenuable: **No**
Incluye equipo para suspender

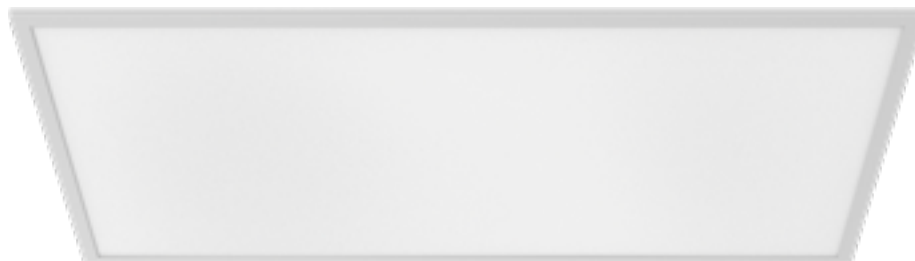
**DOMUS III**

PAN-LED/60/40/S
LUZ BLANCA NEUTRA
○ 4 000 K

60PANLEDL65MVS
LUZ DE DÍA
● 6 500 K



SU TAMAÑO Y DISEÑO
PERMITE CREAR **AMBIENTES
DECORATIVOS**



**MAYOR AHORRO
ENERGÉTICO**



DISTRIBUCIÓN
LUMÍNICA
HOMOGÉNEA



**ALTO
FLUJO LUMINOSO**

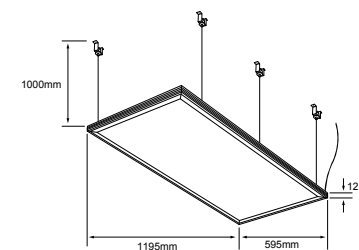

Lumens: **5 400 lm**
Potencia: **60 W**
Volts: **100-240 V ~**

Aplicación: **Suspendido / Empotrado**
Terminado: **Satinado**
IRC: **80**
Vida útil: **25 000 h**
Ángulo: **110 °**

Tipo de lámpara: **LED (Integrado)**
Corte de empotramiento: **1170 mm x 578 mm**
Atenuable: **No**
Incluye equipo para suspender

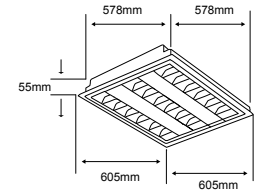
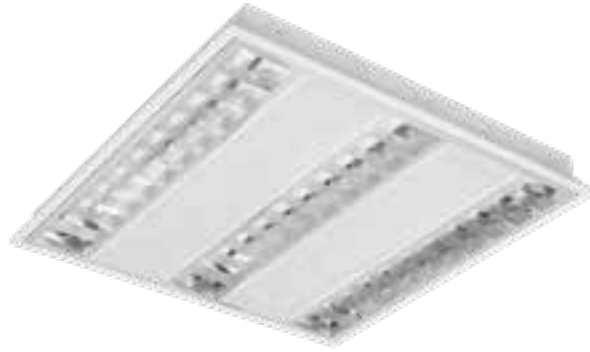

OREMBURGO IV
24LTLED3140V40B
 LUZ BLANCA NEUTRA
 ○ 4 000 K

24LTLED3140V65B
 LUZ DE DÍA
 ○ 6 500 K

Lumens: **1 800 lm**
 Potencia: **24 W**
 Volts: **127 V ~**

Terminado: **Blanco**
 IRC: **80**
 Vida útil: **15 000 h**
 Ángulo: **100 °**

Tipo de base: **G5 x 3**
 Tipo de lámpara: **Tubo LED 8T5LED60V x 3 (Integrado)**
 Corte de empotramiento: **578 mm x 578 mm**
 Atenuable: **No**

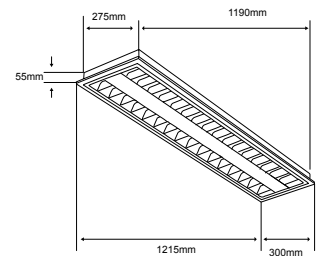

MONTISI III
32LTLED2281V40B
 LUZ BLANCA NEUTRA
 ○ 4 000 K

32LTLED2281V65B
 LUZ DE DÍA
 ○ 6 500 K

Lumens: **2 800 lm**
 Potencia: **32 W**
 Volts: **127 V ~**

Terminado: **Blanco**
 IRC: **80**
 Vida útil: **15 000 h**
 Ángulo: **100 °**

Tipo de base: **G5 x 2**
 Tipo de lámpara: **Tubo LED 16T5LED120V x 2 (Integrado)**
 Corte de empotramiento: **1 190 mm x 275 mm**
 Atenuable: **No**

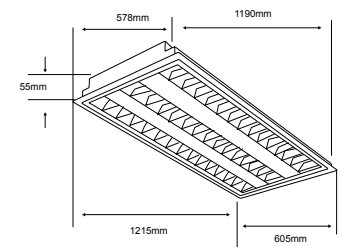

OREMBURGO V
48LTLED3280V40B
 LUZ BLANCA NEUTRA
 ○ 4 000 K

48LTLED3280V65B
 LUZ DE DÍA
 ○ 6 500 K

Lumens: **3 800 lm**
 Potencia: **48 W**
 Volts: **127 V ~**

Terminado: **Blanco**
 IRC: **80**
 Vida útil: **15 000 h**
 Ángulo: **100 °**

Tipo de base: **G5 x 3**
 Tipo de lámpara: **Tubo LED 16T5LED120V x 3 (Integrado)**
 Corte de empotramiento: **578 mm x 1190 mm**
 Atenuable: **No**



MENEN II

60DLTLLED3282V40B

LUZ BLANCA NEUTRA

○ 4 100 K

Lumens: **3 400 lm**

Potencia: **60 W**

Volts: **100 - 127 V ~**

Terminado: **Blanco**

IRC: **80**

Vida útil: **25 000 h**

Ángulo: **100 °**

Tipo de base: **G5 x 3**

Tipo de lámpara:

Tubo LED T5D120-LED x 3 (Incluida)

Atenuable: **Si**

MENEN I

48LTLLLED3282V40B

LUZ BLANCA NEUTRA

○ 4 100 K

Lumens: **3 800 lm**

Potencia: **48 W**

Volts: **127 V ~**

Terminado: **Blanco**

IRC: **80**

Vida útil: **15 000 h**

Ángulo: **100 °**

Tipo de base: **G5 x 3**

Tipo de lámpara:

Tubo LED 16T5LED120V x 3 (Incluida)

Atenuable: **No**

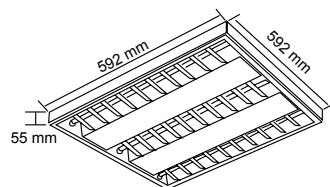
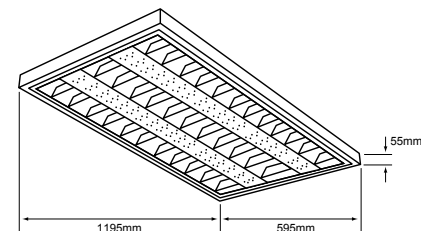

MONTOYA II

24LTLLLED3142V40B

LUZ BLANCA NEUTRA

○ 4 000 K

Lumens: **1 800 lm**

Potencia: **24 W**

Volts: **127 V ~**

24LTLLLED3142V65B

LUZ DE DÍA

○ 6 500 K

Terminado: **Blanco**

IRC: **80**

Vida útil: **15 000 h**

Ángulo: **100 °**

Tipo de base: **G5 x 3**

Tipo de lámpara: **Tubo LED 8T5LED60V x 3 (Incluida)**

Atenuable: **No**

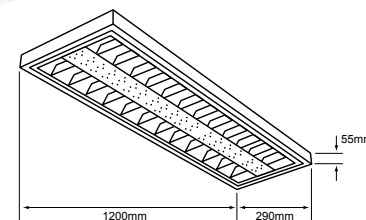
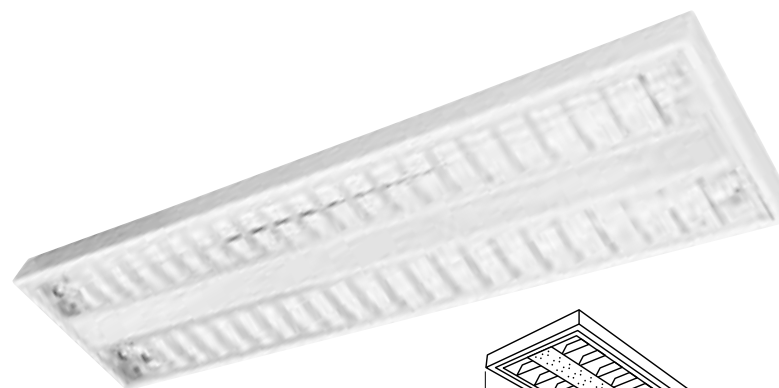

MONTI SI V

32LTLLLED2282V40B

LUZ BLANCA NEUTRA

○ 4 100 K

Lumens: **2 800 lm**

Potencia: **32 W**

Volts: **127 V ~**

Terminado: **Blanco**

IRC: **80**

Vida útil: **15 000 h**

Ángulo: **100 °**

Tipo de base: **G5 x 2**

Tipo de lámpara: **Tubo LED 16T5LED120V x 2 (Incluida)**

Atenuable: **No**

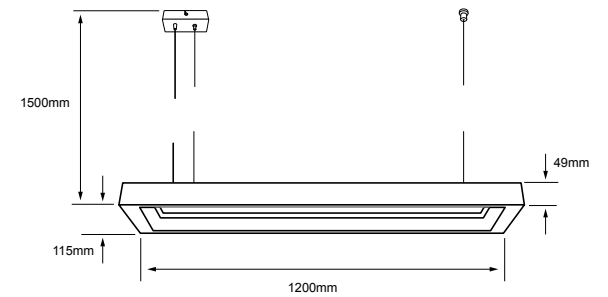

ATENUABLE

TARAZED

40DLFCLED2205V40N

LUZ BLANCA NEUTRA
○ 4 000 K

Lumens: **3 400 lm**

Potencia: **40 W**

Volts: **127 V ~**

Terminado: Negro

IRC: **80**

Vida útil: **30 000 h**

Ángulo: **120 °**

Tipo de lámpara: **LED (integrado)**

Atenuable: **Si**

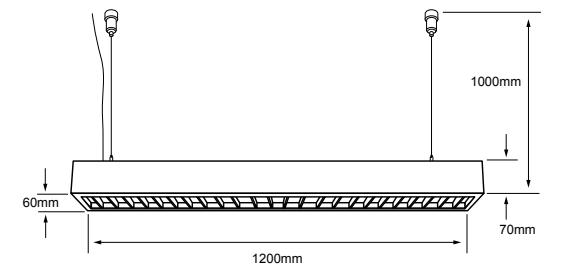
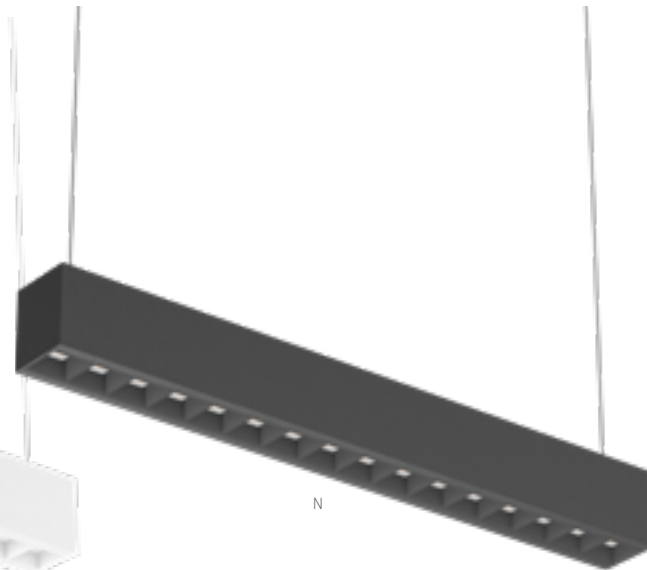
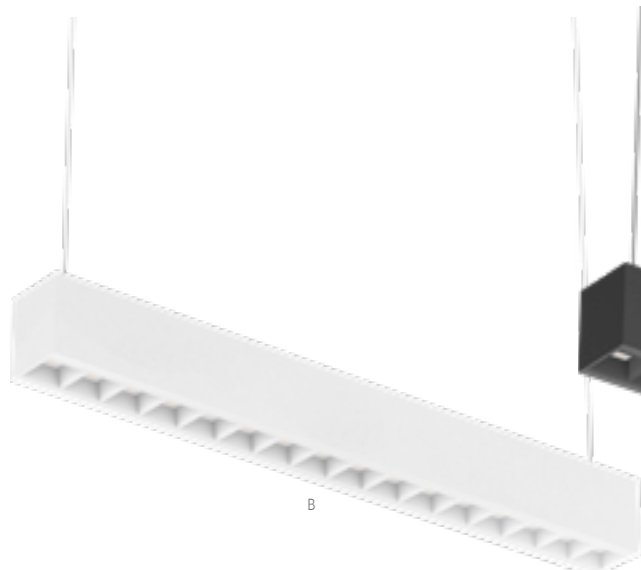

ATENUABLE



GOYA II

40DLFCLED1282V40B Blanco

LUZ BLANCA NEUTRA
○ 4 000 K

Lumens: **4 500 lm**

Potencia: **40 W**

Volts: **127 V ~**

40DLFCLED1282V40N Negro

Aplicación: **Suspendido / Empotrado**

IRC: **80**

Vida útil: **30 000 h**

Ángulo: **100 °**

Tipo de lámpara: **LED (integrado)**

Atenuable: **Si**

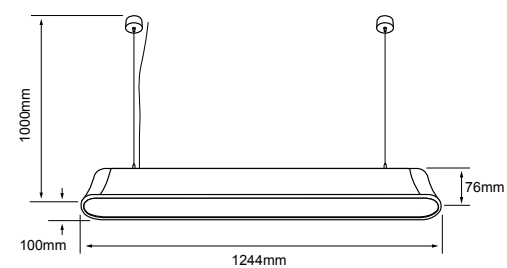

NAMEN I
40LFCLED2203MV40S

LUZ BLANCA NEUTRA
○ 4 000 K

Lumens: **3 030 lm**
Potencia: 40 W
Volts: 100 V ~ 240 V ~

Terminado: **Satin**
IRC: 80
Vida útil: **30 000 h**
Ángulo: 120 °
Tipo de lámpara: LED (Integrado)
Atenuable: **No**

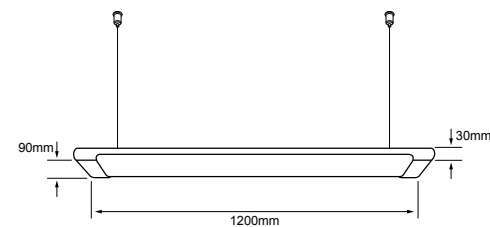

WASAT
40DLFCLED1002V40N

LUZ BLANCA NEUTRA
○ 4 000 K

Lumens: **3 200 lm**
Potencia: 40 W
Volts: 127 V ~

Terminado: **Negro**
IRC: 80
Vida útil: **30 000 h**
Ángulo: 120 °
Tipo de lámpara: LED (Integrado)
Atenuable: **Si**



ATENUABLE



ILUMINA HACIA ARRIBA Y ABAJO

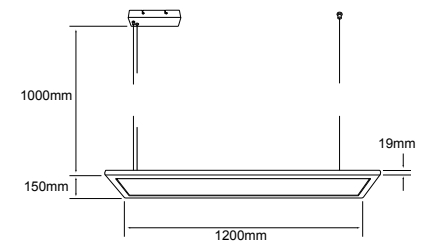

ALYAD
45DLFCLED1003V40B

LUZ BLANCA NEUTRA
○ 4 000 K

Lumens: 3 000 lm
Potencia: 45 W
Volts: 127 V ~

Terminado: Blanco
IRC: 80
Vida útil: **30 000 h**
Ángulo: 270°
Tipo de lámpara: LED (Integrado)
Atenuable: Si



NASHVILLE
PAN-LED/R40/40

LUZ BLANCA NEUTRA
○ 4 000 K

Lumens: **2 000 lm**
Potencia: **24 W**
Volts: **100-240 V ~**

Terminado: **Blanco**
IRC: **80**
Vida útil: **25 000 h**
Ángulo: **120 °**
Tipo de lámpara: **LED (Integrado)**
Atenuable: **No**



NASHVILLE I
PAN-LED/R60/40

LUZ BLANCA NEUTRA
○ 4 000 K

Lumens: **2 200 lm**
Potencia: **36 W**
Volts: **100-240 V ~**

Terminado: **Blanco**
IRC: **80**
Vida útil: **25 000 h**
Ángulo: **120 °**
Tipo de lámpara: **LED (Integrado)**
Atenuable: **No**

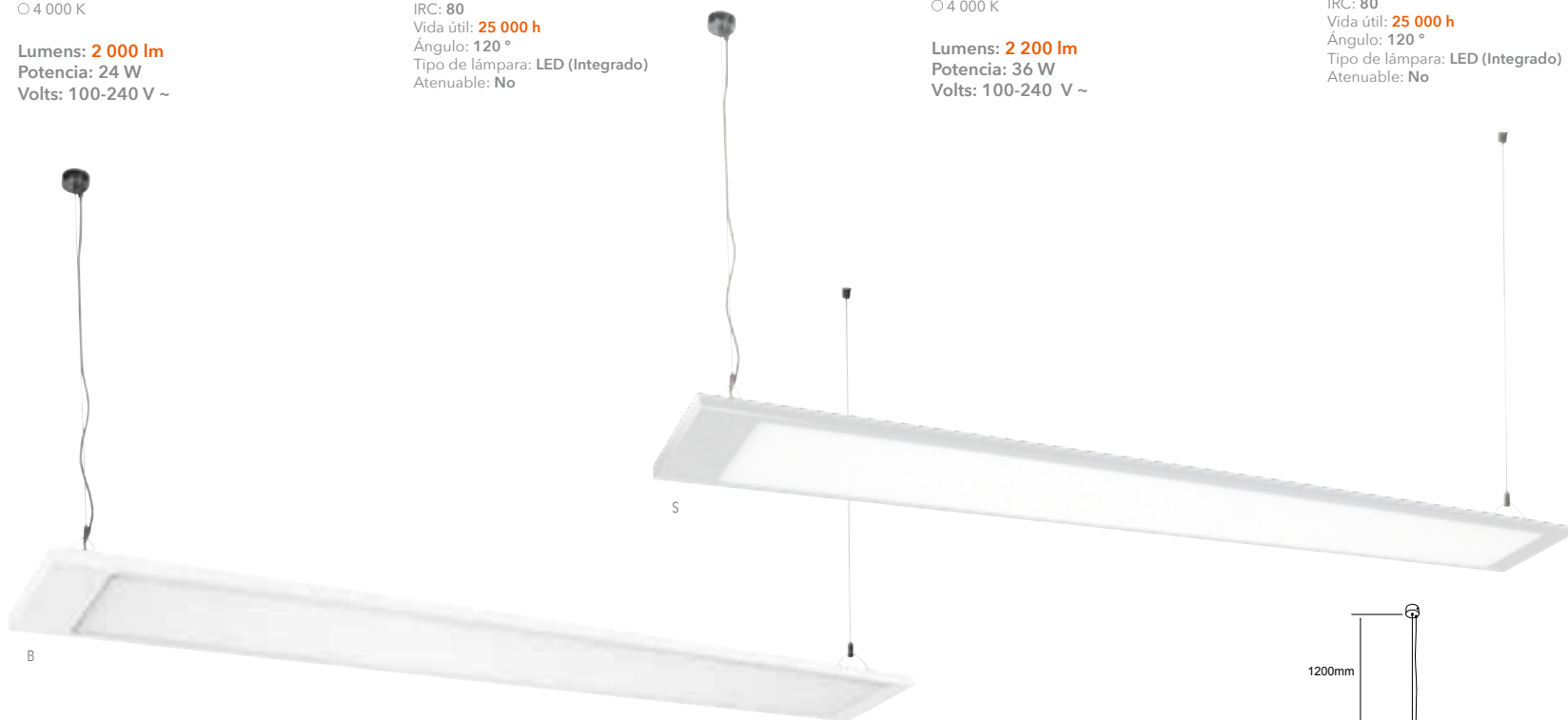

NEIVA
LFCLED-1000/B Blanco

LUZ BLANCA NEUTRA
○ 4 000 K

Lumens: **2 500 lm**
Potencia: **40 W**
Volts: **100-240 V ~**

LFCLED-1000/S Satinado

Aplicación: **Suspendido / Empotrado**
IRC: **80**
Vida útil: **25 000 h**
Ángulo: **110 °**
Tipo de lámpara: **LED (Integrado)**
Atenuable: **No**

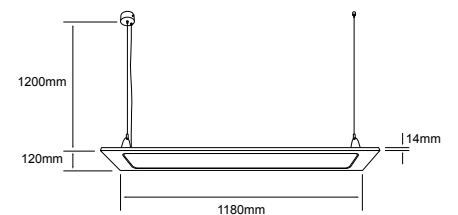

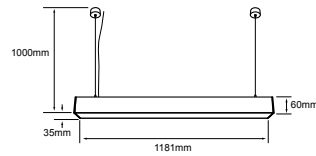

NEIVA II
20LFCLED2204MV40N

LUZ BLANCA NEUTRA
○ 4 000 K

Lumens: 950 lm
Potencia: 20 W
Volts: 100-240 V ~

Terminado: **Negro**
IRC: **80**
Vida útil: **30 000 h**
Ángulo: **120 °**
Tipo de lámpara: **LED (Integrado)**
Atenuable: **No**



DUBHE I
19LFCLED1541MV40S

LUZ BLANCA NEUTRA
○ 4 000 K

Lumens: 1 500 lm
Potencia: 19 W
Volts: 100-240 V ~

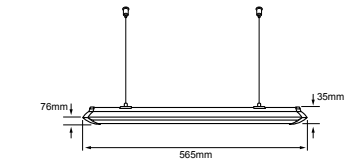

Aplicación: **Suspendido / Sobreponer**
Terminado: **Satinado**
IRC: **80**
Vida útil: **25 000 h**
Ángulo: **120 °**
Tipo de lámpara: **LED (Integrado)**
Atenuable: **No**
Incluye equipo para suspender

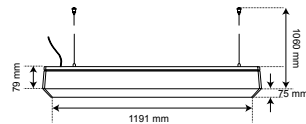

NEIVA III
32LFCLED2202V40S

LUZ BLANCA NEUTRA
○ 4 000 K

Lumens: 3 000 lm
Potencia: 32 W
Volts: 127 V ~

Terminado: **Satin**
IRC: **80**
Vida útil: **15 000 h**
Ángulo: **100 °**
Tipo de base: **G5 X 2**
Tipo de lámpara:
Tubo LED 16T5LED120V40C x 2 (Incluida)
Atenuable: **No**



DUBHE II
38LFCLED1542MV40S

LUZ BLANCA NEUTRA
○ 4 000 K

Lumens: 3 000 lm
Potencia: 38 W
Volts: 100-240 V ~

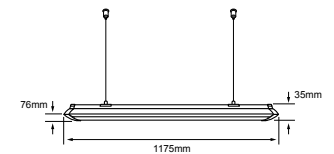

Aplicación: **Suspendido / Sobreponer**
Terminado: **Satinado**
IRC: **80**
Vida útil: **25 000 h**
Ángulo: **120 °**
Tipo de lámpara: **LED (Integrado)**
Atenuable: **No**
Incluye equipo para suspender



INTERIOR
INDUSTRIAL

**DEFINE AMBIENTES DE SEGURIDAD
CON ILUMINACIÓN CONTROLADA
Y AHORRO DE ENERGÍA**

tecnolite[®]
LA LUZ ES TUYA





- Incluye bracket y gancho de suspensión.
- 100 Lm/W

REGOR I 100UFOLED65MVN

LUZ DE DÍA
● 6 500 K

Lumens: **10 000 lm**
Potencia: **100 W**
Volts: **100-277 V ~**

Aplicación:
Suspendido / Sobreponer
Terminado: **Negro**
IRC: **80**
Vida útil: **30 000 h**
Ángulo: **90°**

IP: **65**
Tipo de lámpara: **LED (Integrado)**
Atenuable: **No**
Incluye **Bracket y gancho**
No incluye cable de suspensión

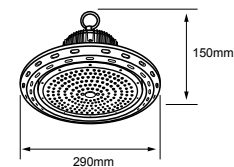

- Incluye bracket y gancho de suspensión.
- 100 Lm/W

REGOR II 150UFOLED65MVN

LUZ DE DÍA
● 6 500 K

Lumens: **15 000 lm**
Potencia: **150 W**
Volts: **100-277 V ~**

Aplicación:
Suspendido / Sobreponer
Terminado: **Negro**
IRC: **80**
Vida útil: **30 000 h**
Ángulo: **90°**

IP: **65**
Tipo de lámpara: **LED (Integrado)**
Atenuable: **No**
Incluye **Bracket y gancho**
No incluye cable de suspensión

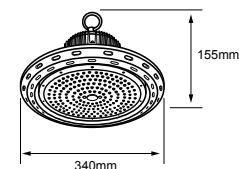

- Incluye bracket y gancho de suspensión.
- 100 Lm/W

REGOR III 200UFOLED65MVN

LUZ DE DÍA
● 6 500 K

Lumens: **20 000 lm**
Potencia: **200 W**
Volts: **100-277 V ~**

Aplicación:
Suspendido / Sobreponer
Terminado: **Negro**
IRC: **80**
Vida útil: **30 000 h**
Ángulo: **90°**

IP: **65**
Tipo de lámpara: **LED (Integrado)**
Atenuable: **No**
Incluye **Bracket y gancho**
No incluye cable de suspensión

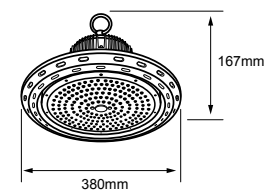



- Incluye bracket y gancho de suspensión.
- 120 Lm/W

SECUNDA I
100UFOLEDL65MVN

LUZ DE DÍA
● 6 500 K

Lumens: **12 000 lm**
Potencia: **100 W**
Volts: **100-277 V ~**

Terminado: **Negro**
IRC: **80**
Vida útil: **30 000 h**
Ángulo: **90°**

IP: **65**
Tipo de lámpara: **LED (Integrado)**
Atenuable: **No**
Incluye Driver LED

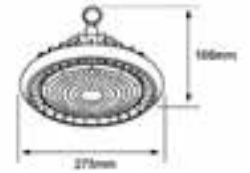

- Incluye bracket y gancho de suspensión.
- 120 Lm/W

SECUNDA II
150UFOLEDL65MVN

LUZ DE DÍA
● 6 500 K

Lumens: **18 000 lm**
Potencia: **150 W**
Volts: **100-277 V ~**

Terminado: **Negro**
IRC: **80**
Vida útil: **30 000 h**
Ángulo: **90°**

IP: **65**
Tipo de lámpara: **LED (Integrado)**
Atenuable: **No**
Incluye Driver LED

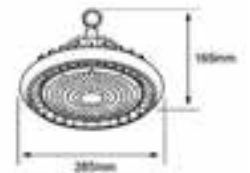

- Incluye bracket y gancho de suspensión.
- 120 Lm/W

SECUNDA III
200UFOLEDL65MVN

LUZ DE DÍA
● 6 500 K

Lumens: **24 000 lm**
Potencia: **200 W**
Volts: **100-277 V ~**

Terminado: **Negro**
IRC: **80**
Vida útil: **30 000 h**
Ángulo: **90°**

IP: **65**
Tipo de lámpara: **LED (Integrado)**
Atenuable: **No**
Incluye Driver LED

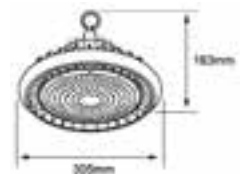

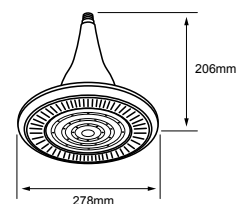

POTENCA I
80UFOELED65MVN

LUZ DE DÍA
● 6 500 K

Lumens: **8 500 lm**
Potencia: 80 W
Volts: 100-240 V ~

Terminado: Negro
IRC: 80
Vida útil: **20 000 h**
Ángulo: 90°

Tipo de base: E40
Tipo de lámpara: LED (Integrado)
Incluye: Driver LED
Atenuable: No
Incluye adaptador E40-E27

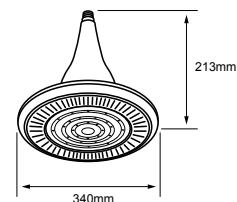

POTENCA II
120UFOELED65MVN

LUZ DE DÍA
● 6 500 K

Lumens: **12 800 lm**
Potencia: 120 W
Volts: 100-240 V ~

Terminado: Negro
IRC: 80
Vida útil: **20 000 h**
Ángulo: 90°
Tipo de base: E40

Tipo de lámpara: LED (Integrado)
Incluye: Driver LED
Atenuable: No
Incluye accesorio de seguridad para sujeción

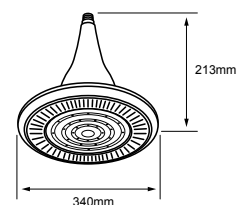

POTENCA III
150UFOELED65MVN

LUZ DE DÍA
● 6 500 K

Lumens: **16 000 lm**
Potencia: 150 W
Volts: 100-240 V ~

Terminado: Negro
IRC: 80
Vida útil: **20 000 h**
Ángulo: 90°
Tipo de base: E40

Tipo de lámpara: LED (Integrado)
Incluye: Driver LED
Atenuable: No
Incluye accesorio de seguridad para sujeción



MEGREZ
160LHLED65MV120

LUZ DE DÍA
● 6 500 K

Lumens: **16 000 lm**
Potencia: 160W
Volts: 100-240 V ~

Terminado: **Blanco**
IRC: **80**
Vida útil: **25 000 h**
Ángulo: **120°**
Tipo de base: **E40**
Atenuable: **No**
Dimensiones del producto: **350 mm x 280 mm**
Incluye adaptador E40 a E27

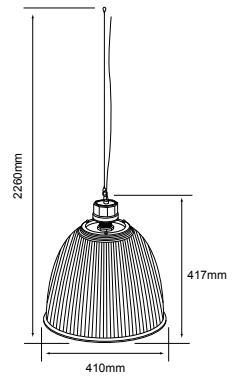

POMPEYA II
50LFC120LED65MVG

LUZ DE DÍA
● 6 500 K

Lumens: **4 500 lm**
Potencia: 50 W
Volts: 100-240 V ~

Terminado: **Gris**
IRC: **80**
Vida útil: **25 000 h**
Tipo de base: **E40**
Tipo de lámpara: **LED 50W (Incluida)**
Atenuable: **No**



CAMPANA INCLUIDA

BIHAM V
LHB-LED/080/65

LUZ DE DÍA
● 6 500 K

Lumens: **7 200 lm**
Potencia: 80 W
Volts: 100-240 V ~

Terminado: **Blanco**
IRC: **80**
Vida útil: **25 000 h**
Ángulo: **120°**
Tipo de base: **E40**
Atenuable: **No**



CAMPANA INCLUIDA

GLIESE III
100LHLED65MV120

LUZ DE DÍA
● 6 500 K

Lumens: **9 000 lm**
Potencia: 100 W
Volts: 100-240 V ~

Terminado: **Blanco**
IRC: **80**
Vida útil: **20 000 h**
Ángulo: **120°**
Tipo de base: **E40**
Atenuable: **No**
Dimensiones del producto: **210 mm x 240 mm**
Incluye **Campaña**
Incluye adaptador E40 a E27



EXTERIOR

REINVENTA TUS MOMENTOS
CON DETALLES DE ILUMINACIÓN

tecnolite®
LA LUZ ES TUYA



EXTERIOR DECORATIVA

TUS EXTERIORES LUCIRÁN COMO NUNCA
CON LA MEJOR LUZ

tecnolite®
LA LUZ ES TUYA



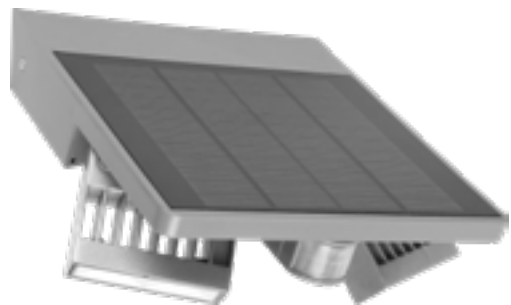

PANEL SOLAR



Sensor de Movimiento



Dirigible

ABERDEEN
SOL-LED/03

LUZ BLANCA NEUTRA
○ 4 000 K

Lumens: **400 lm**
Potencia: **4 W**
Volts: **7.4 Vcc**

Terminado: **Gris**
IRC: **80**
Vida útil: **25 000 h**
Ángulo: **120 °**
IP: **45**
Tipo de lámpara: **LED (Integrado)**
Atenuable: **No**
Duración de batería recargable hasta 4 horas

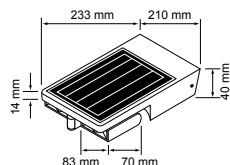

Uso opcional como lámpara de emergencia



PANEL SOLAR



Luz de Emergencia

ABOU
SOL-LED/05

LUZ BLANCA NEUTRA
○ 4 000 K

Lumens: **280 lm**
Potencia: **2.8 W**
Volts: **3.7 Vcc**

Terminado: **Negro**
IRC: **80**
Vida útil: **20 000 h**
Ángulo: **120 °**
IP: **45**
Tipo de lámpara: **LED (Integrado)**
Atenuable: **No**
Duración de batería recargable hasta 3 horas

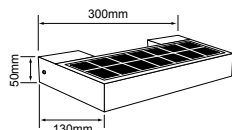

PANEL SOLAR

KOI I
1SOLLED10VD30S

LUZ SUAVE CÁLIDA
● 3 000 K

Lumens: **120 lm**
Potencia: **1 W**
Volts: **3.7 Vcc**

Terminado: **Satinado**
IRC: **80**
Vida útil: **30 000 h**
Ángulo: **180 °**
IP: **44**
Tipo de lámpara: **LED (Integrado)**
Atenuable: **No**
Duración de batería recargable hasta 5 horas
Incluye estaca

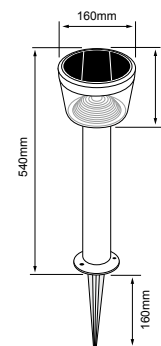

PANEL SOLAR

CAPH
0SOLLED12VD30S

LUZ SUAVE CÁLIDA
● 3 000 K

Lumens: **10 lm**
Potencia: **0.08 W**
Volts: **1.2 Vcc**

Terminado: **Satin**
IRC: **80**
Vida útil: **15 000 h**
IP: **65**
Tipo de lámpara: **LED (Integrado)**
Atenuable: **No**
Duración de batería recargable hasta 7 horas
Incluye estaca

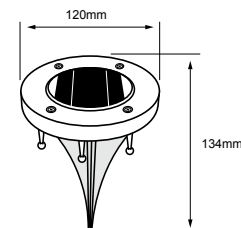

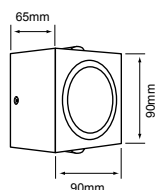

TORCULAR I

09HLED1157MV30N

LUZ SUAVE CÁLIDA
● 3 000 K

Lumens: 135 lm
Potencia: 9 W
Volts: 100-240 V ~

Terminado: **Negro**
Tipo de lámpara: **LED (integrado)**
IRC: **80**
Vida útil: **30 000 h**
Ángulo: **138 °**
IP: **54**
Atenuable: **No**

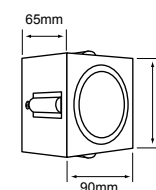

TORCULAR II

10HLED1156MV30N

LUZ SUAVE CÁLIDA
● 3 000 K

Lumens: 366 lm
Potencia: 10 W
Volts: 100-240 V ~

Terminado: **Negro**
Tipo de lámpara: **LED (integrado)**
IRC: **80**
Vida útil: **30 000 h**
Ángulo: **131 °**
IP: **54**
Atenuable: **No**

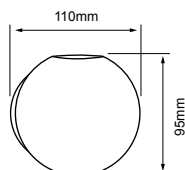

VERITATE II

6HLED1159MV30N

LUZ SUAVE CÁLIDA
● 3 000 K

Lumens: 394 lm
Potencia: 6 W
Volts: 100-240 V ~

Terminado: **Negro**
IRC: **80**
Vida útil: **30 000 h**
Ángulo: **55 °**
IP: **54**
Tipo de lámpara: **LED (integrado)**
Atenuable: **No**

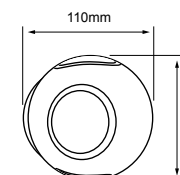

VERITATE I

4HLED1158MV30N

LUZ SUAVE CÁLIDA
● 3 000 K

Lumens: 209 lm
Potencia: 4 W
Volts: 100-240 V ~

Terminado: **Negro**
IRC: **80**
Vida útil: **30 000 h**
Ángulo: **113 °**
IP: **54**
Tipo de lámpara: **LED (integrado)**
Atenuable: **No**



OPHIUCHI I
6HLED427MV30N

LUZ SUAVE CÁLIDA
● 3 000 K

Lumens: **409 lm**
Potencia: 6 W
Volts: 100-240 V ~

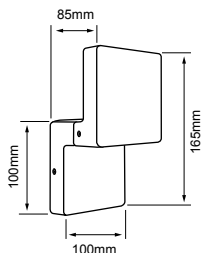

Terminado: **Negro**
IRC: **80**
Vida útil: **30 000 h**
Ángulo: **115 °**
IP: **54**
Tipo de lámpara: **LED (integrado)**
Atenuable: **No**



OPHIUCHI II
6HLED428MV30N

LUZ SUAVE CÁLIDA
● 3 000 K

Lumens: **159 lm**
Potencia: 6 W
Volts: 100-240 V ~

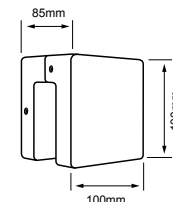

Terminado: **Negro**
IRC: **80**
Vida útil: **30 000 h**
Ángulo: **67 °**
IP: **54**
Tipo de lámpara: **LED (integrado)**
Atenuable: **No**



TITAWIN
09HLED923MV30N

LUZ SUAVE CÁLIDA
● 3 000 K

Lumens: **759 lm**
Potencia: 9 W
Volts: 100-240 V ~

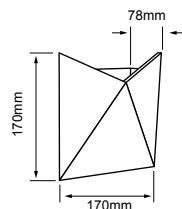

Terminado: **Negro**
IRC: **80**
Vida útil: **30 000 h**
Ángulo: **97 °**
IP: **54**
Tipo de lámpara: **LED (integrado)**
Atenuable: **No**



FANG
12HLED416MV30N

LUZ SUAVE CÁLIDA
● 3 000 K

Lumens: **600 lm**
Potencia: 12 W
Volts: 100-240 V ~

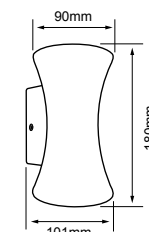

Terminado: **Negro**
IRC: **70**
Vida útil: **15 000 h**
Ángulo: **98 °**
IP: **54**
Tipo de lámpara: **LED (integrado)**
Atenuable: **No**



CINTU II
10HLED191MV30N

LUZ SUAVE CÁLIDA
● 3 000 K

Lumens: **650 lm**
Potencia: 10 W
Volts: 100-240 V ~

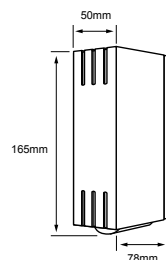

Terminado: **Negro**
Tipo de lámpara: **LED (integrado)**
IRC: **80**
Vida útil: **20 000 h**
Ángulo: **38 - 96 °**
IP: **54**
Atenuable: **No**



SPECTRUM
HLED-921/N
Negro

LUZ SUAVE CÁLIDA
● 3 000 K

Lumens: **400 lm**
Potencia: 8 W
Volts: 100-240 V ~



HLED-921/S
Satinado

IRC: **80**
Vida útil: **15 000 h**
Ángulo: **65 °**
IP: **55**
Tipo de lámpara: **LED (Integrado)**
Atenuable: **No**

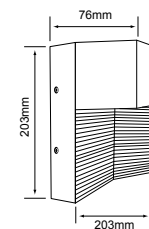

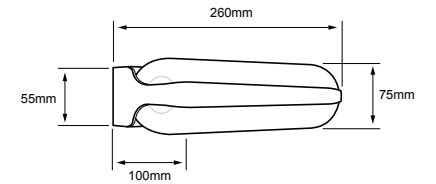
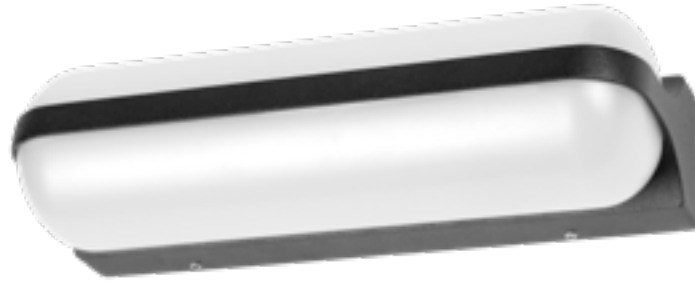

CLAUDIO

13HLED119MV40N

LUZ BLANCA NEUTRA
○ 4 000 K

Lumens: **1 020 lm**
Potencia: 13 W
Volts: 100-240 V ~

Terminado: **Negro**
Tipo de lámpara: **LED (integrado)**
Incluye: **Driver LED**
IRC: 80

Vida útil: **20 000 h**
Ángulo: **286 °**
IP: **54**
Atenuable: **No**

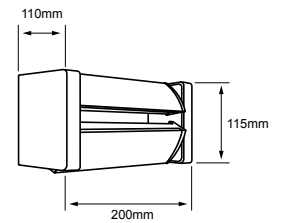

VENATICI

12HLED122MV40N

LUZ BLANCA NEUTRA
○ 4 000 K

Lumens: **830 lm**
Potencia: 12 W
Volts: 100-240 V ~

Terminado: **Negro**
Tipo de lámpara: **LED (integrado)**
Incluye: **Driver LED**
IRC: 80

Vida útil: **20 000 h** Ángulo: **105 °**
IP: **54**
Atenuable: **No**

ENEKO

8HLED137MV30N
LUZ SUAVE CÁLIDA
● 3 000 K

Lumens: **350 lm**
Potencia: 8.5 W
Volts: 100-240 V ~

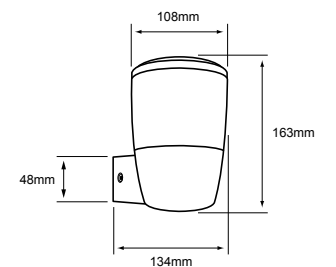

8HLED137MV40N

LUZ BLANCA NEUTRA
○ 4 000 K

Terminado: **Negro**
Tipo de lámpara: **LED (integrado)**
Incluye: **Driver LED**
IRC: 80

Vida útil: **20 000 h**
Ángulo: **313 °**
IP: **54**
Atenuable: **No**

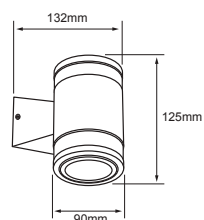

NUEVO
LUSITANIA
6HLED1167MV30N

LUZ SUAVE CÁLIDA
● 3 000 K

Lumens: **482 lm**
Potencia: **6 W**
Volts: **100-240 V ~**

Terminado: **Negro**
IRC: **80**
Vida útil: **30 000 h**
Ángulo: **25 °**
IP: **54**
Tipo de lámpara: **LED (integrado)**
Atenuable: **No**

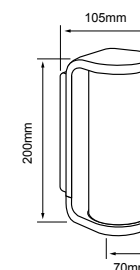

WEZEN
10HLED947V30G

LUZ SUAVE CÁLIDA
● 3 000 K

Lumens: **600 lm**
Potencia: **10 W**
Volts: **127 V ~**

Terminado: **Gris**
IRC: **80**
Vida útil: **20 000 h**
Ángulo: **118 °**
IP: **44**
Tipo de lámpara: **LED (integrado)**
Atenuable: **No**

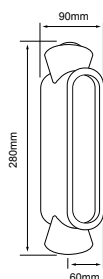

VINDEMIATRIX
15HLED1154MV30N

LUZ SUAVE CÁLIDA
● 3 000 K

Lumens: **374 lm**
Potencia: **15 W**
Volts: **100-240 V ~**

Terminado: **Negro**
IRC: **80**
Vida útil: **30 000 h**
Ángulo: **133 °**
IP: **54**
Tipo de lámpara: **LED (integrado)**
Atenuable: **No**

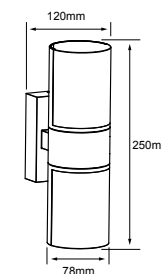

WURREN
16HLED1163V30

LUZ SUAVE CÁLIDA
● 3 000 K

Lumens: **950 lm**
Potencia: **16 W**
Volts: **127 V ~**

Terminado: **Gris**
IRC: **80**
Vida útil: **20 000 h**
Ángulo: **135 °**
IP: **44**
Tipo de lámpara: **LED (integrado)**
Atenuable: **No**



ENCKE
HLED-1105/S

LUZ SUAVE CÁLIDA
● 3 000 K

Lumens: 600 lm
Potencia: 9 W
Volts: 127 V ~

Terminado: **Satin**
IRC: **80**
Vida útil: **20 000 h**
Ángulo: **49 °**
IP: **44**
Tipo de lámpara: **LED (Integrado)**
Atenuable: **No**

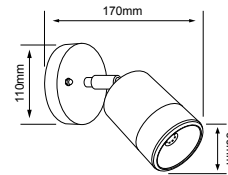
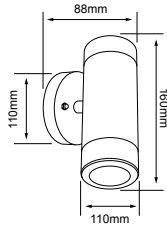

ZINNER
HLED-761/S

LUZ SUAVE CÁLIDA
● 3 000 K

Lumens: 300 lm
Potencia: 4.5 W
Volts: 127 V ~

Terminado: **Satin**
IRC: **80**
Vida útil: **20 000 h**
Ángulo: **49 °**
IP: **44**
Tipo de lámpara: **LED (Integrado)**
Atenuable: **No**
Dirigible

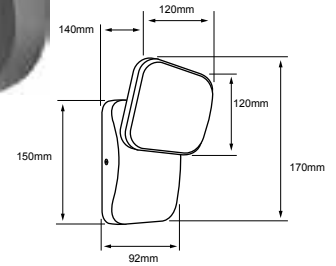

POLUX II
13HLED1179MV40G

LUZ BLANCA NUETRA
○ 4 000 K

Lumens: 1 000 lm
Potencia: 13 W
Volts: 100-240 V ~

Terminado: **Gris**
IRC: **80**
Vida útil: **20 000 h**
Ángulo: **111 °**
IP: **44**
Tipo de lámpara: **LED (integrado)**
Atenuable: **No**
Incluye: **Driver LED**



TUREIS
6HLED403MV30N

LUZ SUAVE CÁLIDA
● 3 000 K

Lumens: 164 lm
Potencia: 6 W
Volts: 100-240 V ~



Terminado: **Negro**
IRC: **80**
Vida útil: **30 000 h**
Ángulo: **114 °**
IP: **54**
Tipo de lámpara: **LED (integrado)**
Atenuable: **No**

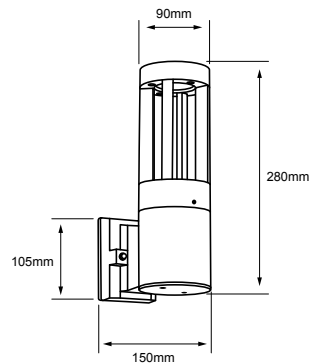

TIAKI
12HLED417MV30N

LUZ SUAVE CÁLIDA
● 3 000 K

Lumens: 500 lm
Potencia: 12 W
Volts: 100-240 V ~

Terminado: **Negro**
IRC: **70**
Vida útil: **15 000 h**
Ángulo: **310 °**
IP: **54**
Tipo de lámpara: **LED (integrado)**
Atenuable: **No**

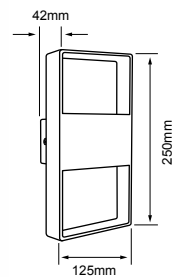



CHORT
16HLED1053V30G

LUZ SUAVE CÁLIDA
● 3 000 K

Lumens: 1 030 lm
Potencia: 16.5 W
Volts: 127 V ~

Terminado: **Gris**
IRC: **80**
Vida útil: **20 000 h**
Ángulo: **90 °**
IP: **54**
Tipo de lámpara: **LED (Integrado)**
Atenuable: **No**

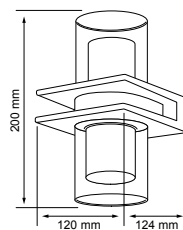

GRUS
10HLED948V30G

LUZ SUAVE CÁLIDA
● 3 000 K

Lumens: 400 lm
Potencia: 10.5 W
Volts: 100-127 V ~

Terminado: **Gris**
IRC: **80**
Vida útil: **20 000 h**
Ángulo: **81 °**
IP: **44**
Tipo de lámpara: **LED (Integrado)**
Atenuable: **No**

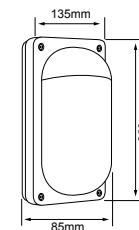

AUSTRALIS
09HLED1177MV30B
Blanco

LUZ SUAVE CÁLIDA
● 3 000 K

Lumens: 420 lm
Potencia: 9 W
Volts: 100-240 V ~

09HLED1177MV30G
Gris

IRC: **80**
Vida útil: **15 000 h**
Ángulo: **111 °**
IP: **44**
Tipo de lámpara: **LED (Integrado)**
Atenuable: **No**

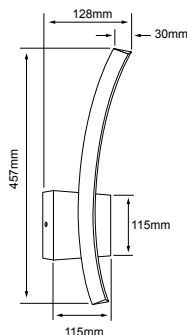

FURUD
27HLED1162V30G

LUZ SUAVE CÁLIDA
● 3 000 K

Lumens: 1 100 lm
Potencia: 27 W
Volts: 127 V ~



Giratorio, ajustable

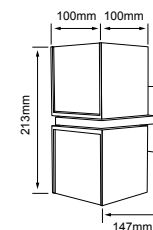

Terminado: **Gris**
IRC: **80**
Vida útil: **20 000 h**
Ángulo: **110 °**

IP: **54**
Tipo de lámpara: **LED (Integrado)**
Atenuable: **No**
Giratorio / Ajustable



ANTLIA

12DHLED207V30N

LUZ SUAVE CÁLIDA
● 3 000 K

Lumens: **328 lm**
Potencia: **12 W**
Volts: **127 V ~**

Terminado: **Negro**
IRC: **80**
Vida útil: **30 000 h**
Ángulo: **120 °**
Tipo de lámpara: **LED (Integrado)**
Atenuable: **Si**

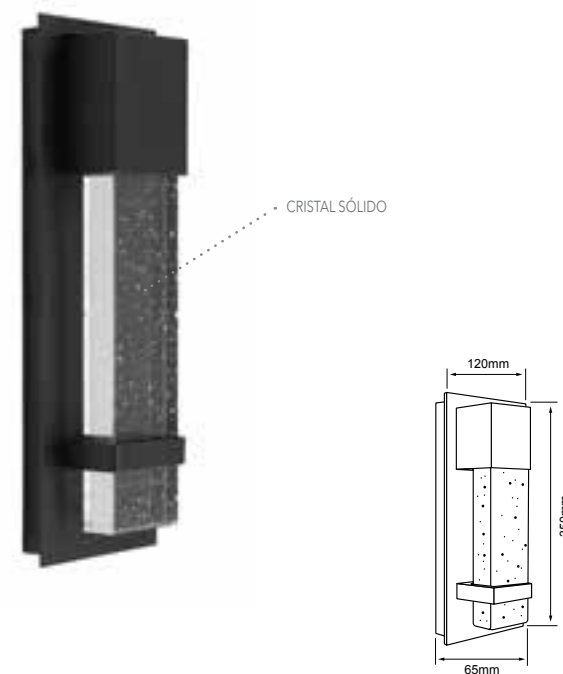

ANDROMEDA

10DHLED206V30N

LUZ SUAVE CÁLIDA
● 3 000 K

Lumens: **307 lm**
Potencia: **10 W**
Volts: **127 V ~**

Terminado: **Negro**
IRC: **80**
Vida útil: **30 000 h**
Ángulo: **120 °**
Tipo de lámpara: **LED (Integrado)**
Atenuable: **Si**

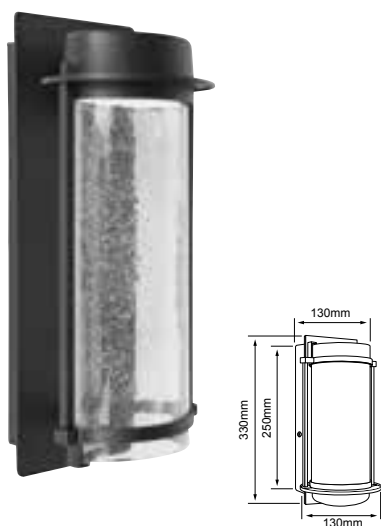

TUTTLE

HLED-202/30/N

LUZ SUAVE CÁLIDA
● 3 000 K

Lumens: **730 lm**
Potencia: **16 W**
Volts: **127 V ~**

Terminado: **Negro**
IRC: **80**
Vida útil: **20 000 h**
Ángulo: **12°**
IP: **44**
Tipo de lámpara: **LED (Integrado)**
Atenuable: **No**



CRUX

HLED-201/N

LUZ SUAVE CÁLIDA
● 3 000 K

Lumens: **800 lm**
Potencia: **16 W**
Volts: **100-127 V ~**

Terminado: **Negro**
IRC: **80**
Vida útil: **20 000 h**
Ángulo: **120°**
IP: **44**
Tipo de lámpara: **LED (Integrado)**
Atenuable: **No**



CRUX II

24HLED203V30G

LUZ SUAVE CÁLIDA
● 3 000 K

Lumens: **850 lm**
Potencia: **24 W**
Volts: **100-127 V ~**

Terminado: **Gris**
IRC: **80**
Vida útil: **15 000 h**
Ángulo: **257 °**
IP: **45**
Tipo de lámpara: **LED (Integrado)**
Atenuable: **No**

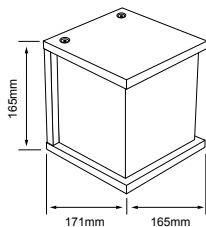

TOULON II
10HLED1200V30S

LUZ SUAVE CÁLIDA
● 3 000 K

Lumens: **320 lm**
Potencia: 10.5 W
Volts: 100-127 V ~

Terminado: **Satin**
IRC: **80**
Vida útil: **20 000 h**
Ángulo: **82 °**
IP: **44**
Tipo de lámpara: **LED (Integrado)**
Atenuable: **No**

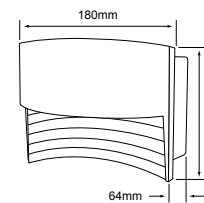

SPECTRUM II
13HLED922V30G

LUZ SUAVE CÁLIDA
● 3 000 K

Lumens: **520 lm**
Potencia: 13 W
Volts: 100-127 V ~

Terminado: **Gris**
IRC: **80**
Vida útil: **20 000 h**
Ángulo: **48 °**
IP: **44**
Tipo de lámpara: **LED (Integrado)**
Atenuable: **No**



B

12HLED945MV30S
Satinado



S

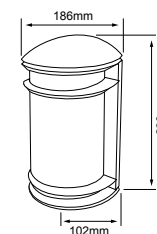

URBINO II
12HLED945MV30B
Blanco

LUZ SUAVE CÁLIDA
● 3 000 K

Lumens: **640 lm**
Potencia: 12 W
Volts: 100-240 V ~

IRC: **80**
Vida útil: **15 000 h**
Ángulo: **120 °**
IP: **44**
Tipo de lámpara: **LED (Integrado)**
Atenuable: **No**

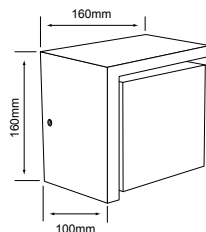

COPEINA
HLED-1051/30/G

LUZ SUAVE CÁLIDA
● 3 000 K

Lumens: **900 lm**
Potencia: 15 W
Volts: 100-240 V ~

Terminado: **Gris**
IRC: **80**
Vida útil: **15 000 h**
Ángulo: **130 °**
IP: **65**
Tipo de lámpara: **LED (Integrado)**
Atenuable: **No**

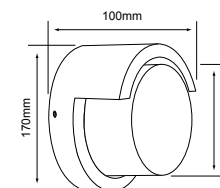

COPEINA I
HLED-1052/30/G

LUZ SUAVE CÁLIDA
● 3 000 K

Lumens: **900 lm**
Potencia: 15 W
Volts: 100-240 V ~

Terminado: **Gris**
IRC: **80**
Vida útil: **15 000 h**
Ángulo: **130 °**
IP: **65**
Tipo de lámpara: **LED (Integrado)**
Atenuable: **No**



HYADUM HLED-847/30/G

LUZ SUAVE CÁLIDA
● 3 000 K

Lumens: **420 lm**
Potencia: 9 W
Volts: 127 V ~

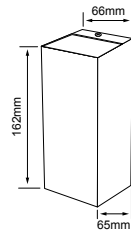

Terminado: Gris
IRC: 80
Vida útil: **20 000 h**
Ángulo: 41 °
IP: 44
Tipo de lámpara: LED (Integrado)
Atenuable: No



TAIGETE HLED-408/G

LUZ SUAVE CÁLIDA
● 3 000 K

Lumens: **700 lm**
Potencia: 17 W
Volts: 100-127 V ~

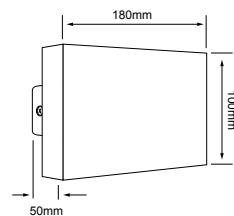

Terminado: Gris
IRC: 80
Vida útil: **20 000 h**
Ángulo: 19 °
IP: 44
Tipo de lámpara: LED (Integrado)
Atenuable: No



PERSEIDA HLED-1152/G

LUZ SUAVE CÁLIDA
● 3 000 K

Lumens: **600 lm**
Potencia: 16 W
Volts: 127 V ~

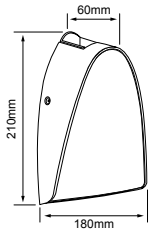

Terminado: Gris
IRC: 80
Vida útil: **20 000 h**
Ángulo: 150 °
IP: 54
Tipo de lámpara: LED (Integrado)
Atenuable: No



Ajustable

PROCYON HLED-1178/30/G

LUZ SUAVE CÁLIDA
● 3 000 K

Lumens: **800 lm**
Potencia: 10 W
Volts: 127 V ~

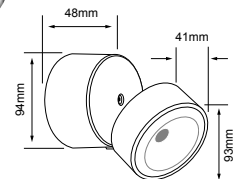

Terminado: Gris
IRC: 80
Vida útil: **20 000 h**
Ángulo: 107 °
IP: 54
Tipo de lámpara: LED (Integrado)
Atenuable: No
Ajustable

PLEYONE 10HLED407VG

LUZ SUAVE CÁLIDA
● 3 000 K

Lumens: **500 lm**
Potencia: 9.5 W
Volts: 100-127 V ~



Terminado: Gris
IRC: 80
Vida útil: **20 000 h**
Ángulo: 22 °
IP: 44
Tipo de lámpara: LED (Integrado)
Incluye: Driver LED



AACHEN II
8HLED1180MV30N

LUZ SUAVE CÁLIDA
● 3 000 K

Lumens: **600 lm**
Potencia: 8 W
Volts: 100-240 V ~

Terminado: **Negro**
IRC: **80**
Vida útil: **30 000 h**
Ángulo: 120 °
IP: 65
Tipo de lámpara: LED (Integrado)
Atenuable: No



AACHEN III
8HLED1181MV30N

LUZ SUAVE CÁLIDA
● 3 000 K

Lumens: **600 lm**
Potencia: 8 W
Volts: 100-240 V ~

Terminado: **Negro**
IRC: **80**
Vida útil: **30 000 h**
Ángulo: 120 °
IP: 65
Tipo de lámpara: LED (Integrado)
Atenuable: No



ACANTHUS
HLED-117/30/N

LUZ SUAVE CÁLIDA
● 3 000 K

Lumens: **600 lm**
Potencia: 12 W
Volts: 100-240 V ~

Terminado: **Negro**
IRC: **80**
Vida útil: **15 000 h**
Ángulo: 258 °
IP: 65
Tipo de lámpara: LED (Integrado)
Atenuable: No

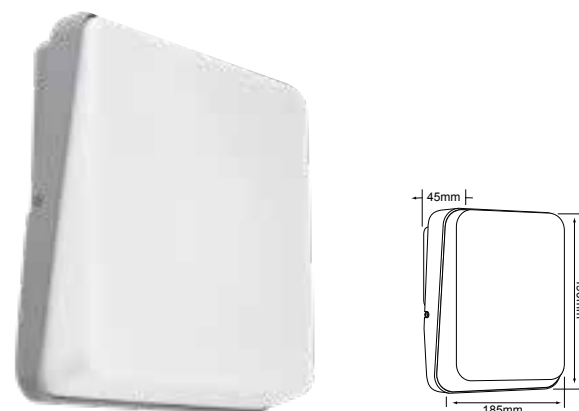

CORIDORA
HLED-1173/30/S

LUZ SUAVE CÁLIDA
● 3 000 K

Lumens: **650 lm**
Potencia: 14.5 W
Volts: 100-240 V ~

Terminado: **Satin**
IRC: **80**
Vida útil: **20 000 h**
Ángulo: 120 °
IP: 54
Tipo de lámpara: LED (Integrado)
Atenuable: No



AL MANAMA I
HLED-371/N

LUZ BLANCA NEUTRA
○ 4 000 K

Lumens: **1 200 lm**
Potencia: 20 W
Volts: 100-240 V ~

Terminado: **Negro**
IRC: **80**
Vida útil: **20 000 h**
Ángulo: 30 °
IP: 45
Tipo de lámpara: LED (Integrado)
Atenuable: No



AL MANAMA
HLED-370/N

LUZ BLANCA NEUTRA
○ 4 000 K

Lumens: **450 lm**
Potencia: 9 W
Volts: 100-240 V ~

Terminado: **Negro**
IRC: **80**
Vida útil: **20 000 h**
Ángulo: 30 °
IP: 45
Tipo de lámpara: LED (Integrado)
Atenuable: No



KAUS I
28HLED413V30S

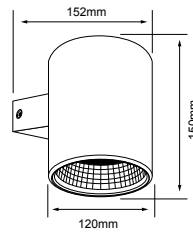

LUZ SUAVE CÁLIDA
● 3 000 K

Lumens: **2 185 lm**
Potencia: **28 W**
Volts: **100-127 V ~**

Terminado: **Satin**
IRC: **80**
Vida útil: **15 000 h**
Ángulo: **282 °**
IP: **65**
Tipo de lámpara: **LED (Integrado)**
Atenuable: **No**



KAUS II
24HLED414V30S

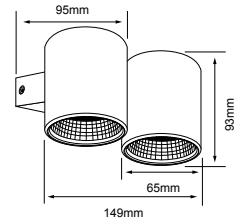

LUZ SUAVE CÁLIDA
● 3 000 K

Lumens: **1 441 lm**
Potencia: **24 W**
Volts: **100-127 V ~**

Terminado: **Satin**
IRC: **80**
Vida útil: **15 000 h**
Ángulo: **205 °**
IP: **65**
Tipo de lámpara: **LED (Integrado)**
Atenuable: **No**



COLINA I
HLED-116/AL

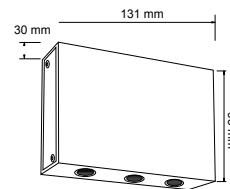

LUZ SUAVE CÁLIDA
● 3 000 K

Lumens: **300 lm**
Potencia: **6 W**
Volts: **100-240 V ~**

Terminado: **Aluminio**
IRC: **80**
Vida útil: **20 000 h**
Ángulo: **25 °**
IP: **44**
Tipo de lámpara: **LED (Integrado)**
Atenuable: **No**



ABIYÁN
HLED-810/6W/40

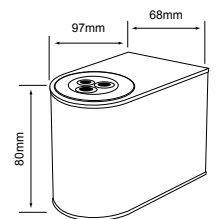

LUZ BLANCA NEUTRA
○ 4 000 K

Lumens: **500 lm**
Potencia: **6 W**
Volts: **100-240 V ~**

Terminado: **Satinado**
IRC: **80**
Vida útil: **25 000 h**
Ángulo: **45 °**
IP: **54**
Tipo de lámpara: **LED (Integrado)**
Atenuable: **No**



PRAVIA
HLED-210/7W/30/S

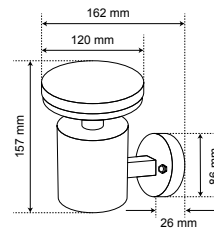

LUZ SUAVE CÁLIDA
● 3 000 K

Lumens: **260 lm**
Potencia: **7 W**
Volts: **100-240 V ~**

Terminado: **Satinado**
IRC: **80**
Vida útil: **30 000 h**
Ángulo: **120 °**
IP: **45**
Tipo de lámpara: **LED (Integrado)**
Atenuable: **No**



TORINO
HLED-105/S

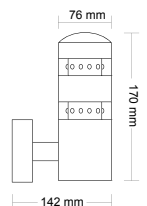

LUZ SUAVE CÁLIDA
● 3 000 K

Lumens: **70 lm**
Potencia: **3 W**
Volts: **100-127 V ~**

Terminado: **Satinado**
IRC: **80**
Vida útil: **15 000 h**
Ángulo: **15 °**
IP: **45**
Tipo de lámpara: **LED (Integrado)**
Atenuable: **No**

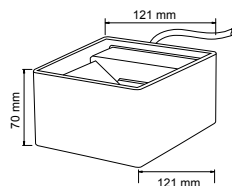

ZIBO

HLED-401/7.5W/30/B

LUZ SUAVE CÁLIDA
● 3 000 K

Lumens: **250 lm**
Potencia: 7.5 W
Volts: 100-240 V ~

Terminado: Blanco
IRC: 80
Vida útil: **20 000 h**
Ángulo: 155 ° (Ajustable)
IP: 45
Tipo de lámpara: LED (Integrado)
Atenuable: No

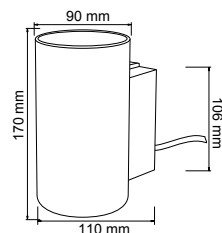

ZIGONG

HLED-402/7.5W/30/B

LUZ SUAVE CÁLIDA
● 3 000 K

Lumens: **150 lm**
Potencia: 7.5 W
Volts: 100-240 V ~

Terminado: Blanco
IRC: 80
Vida útil: **20 000 h**
Ángulo: 160 °
IP: 45
Tipo de lámpara: LED (Integrado)
Atenuable: No



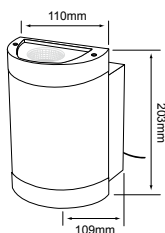

ARBOREA
HLED-843/30/G

LUZ SUAVE CÁLIDA
● 3 000 K

Lumens: **700 lm**
Potencia: 14.5 W
Volts: 100-240 V ~

Terminado: **Gris**
IRC: **80**
Vida útil: **20 000 h**
Ángulo: **34°**
IP: **44**
Tipo de lámpara: **LED (Integrado)**
Atenuable: **No**

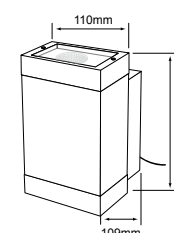

BETULA
HLED-842/30/G

LUZ SUAVE CÁLIDA
● 3 000 K

Lumens: **700 lm**
Potencia: 14.5 W
Volts: 100-240 V ~

Terminado: **Gris**
IRC: **80**
Vida útil: **20 000 h**
Ángulo: **31°**
IP: **44**
Tipo de lámpara: **LED (Integrado)**
Atenuable: **No**

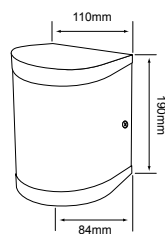

EDULIS
HLED-844/30/CR

LUZ SUAVE CÁLIDA
● 3 000 K

Lumens: **900 lm**
Potencia: 14.5 W
Volts: 100-240 V ~

Terminado: **Cromado**
IRC: **80**
Vida útil: **20 000 h**
Ángulo: **180°**
IP: **54**
Tipo de lámpara: **LED (Integrado)**
Atenuable: **No**

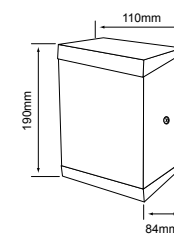

FLAVUS
HLED-845/30/CR

LUZ SUAVE CÁLIDA
● 3 000 K

Lumens: **900 lm**
Potencia: 14.5 W
Volts: 100-240 V ~

Terminado: **Cromado**
IRC: **80**
Vida útil: **20 000 h**
Ángulo: **180°**
IP: **54**
Tipo de lámpara: **LED (Integrado)**
Atenuable: **No**

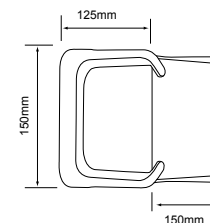

KYBOX
HLED-1201/G

LUZ SUAVE CÁLIDA
● 3 000 K

Lumens: **560 lm**
Potencia: 11 W
Volts: 100-240 V ~

Terminado: **Gris**
IRC: **80**
Vida útil: **20 000 h**
Ángulo: **155°**
IP: **54**
Tipo de lámpara: **LED (Integrado)**
Atenuable: **No**

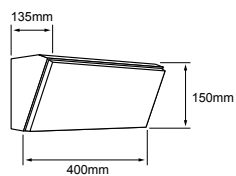

NUEVO
MALMOK I
30HLED1215MV30G

LUZ SUAVE CÁLIDA
● 3 000 K

Lumens: **1948 lm**
Potencia: 30 W
Volts: 100-240 V ~

Terminado: Gris
IRC: 80
Vida útil: **30 000 h**
Ángulo: 115 °
IP: 65
Tipo de lámpara: LED (Integrado)
Atenuable: No

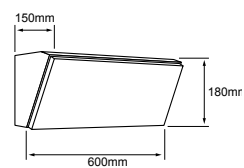

NUEVO
MALMOK II
42HLED1216MV30G

LUZ SUAVE CÁLIDA
● 3 000 K

Lumens: **2233 lm**
Potencia: 42 W
Volts: 100-240 V ~

Terminado: Gris
IRC: 80
Vida útil: **30 000 h**
Ángulo: 115 °
IP: 65
Tipo de lámpara: LED (Integrado)
Atenuable: No



RAVENNE
HLED-840

LUZ BLANCA NEUTRA
○ 4 000 K

Lumens: **300 lm**
Potencia: 6 W
Volts: 100-240 V ~

Terminado: Negro
IRC: 80
Vida útil: **15 000 h**
Ángulo: 70 °
IP: 55
Tipo de lámpara: LED (Integrado)
Atenuable: No

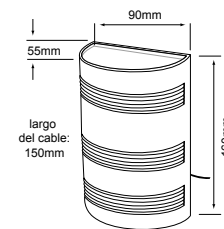

RAWENNA
HLED-841

LUZ BLANCA NEUTRA
○ 4 000 K

Lumens: **300 lm**
Potencia: 6 W
Volts: 100-240 V ~

Terminado: Negro
IRC: 80
Vida útil: **15 000 h**
Ángulo: 70 °
IP: 55
Tipo de lámpara: LED (Integrado)
Atenuable: No

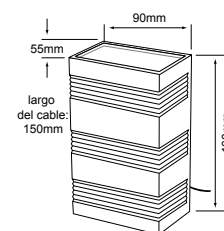

ANDORRA
HLED-404/5W/40/S

LUZ BLANCA NEUTRA
○ 4 000 K

Lumens: **160 lm**
Potencia: 5 W
Volts: 100-127 V ~

Terminado: Satinado
IRC: 80
Vida útil: **20 000 h**
Ángulo: 50 °
IP: 45
Tipo de lámpara: LED (Integrado)
Atenuable: No

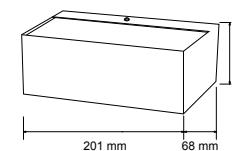

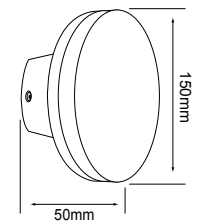

ADHARA I

HLED-1174/30/G

LUZ SUAVE CÁLIDA
● 3 000 K

Lumens: **700 lm**
Potencia: 10 W
Volts: 100-240 V ~

Terminado: Gris
IRC: 80
Vida útil: **15 000 h**
Ángulo: 106°
IP: 65
Tipo de lámpara: LED (Integrado)
Atenuable: No

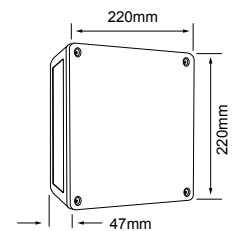

TAIGETE II

14HLED409MV30G

LUZ SUAVE CÁLIDA
● 3 000 K

Lumens: **580 lm**
Potencia: 14.5 W
Volts: 100-240 V ~

Terminado: Gris
IRC: 80
Vida útil: **20 000 h**
Ángulo: 55°
IP: 44
Tipo de lámpara: LED (Integrado)
Atenuable: No



REJILLA DESMONTABLE

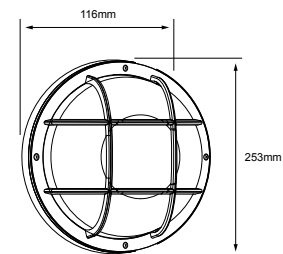

APUS
13HLED1171SCCTB

TEMPERATURA DE COLOR AJUSTABLE 2 STEP
● 3 000 K - 5 000 K

Lumens: **860 - 890 lm**
Potencia: **13 W**
Volts: **127 V ~**

Terminado: **Blanco**
IRC: **80**
Vida útil: **20 000 h**
Ángulo: **132 °**

IP: **44**
Tipo de lámpara: **LED (integrado)**
Atenuable: **No**
Cambio de temperatura de color con switch de pared. Rejilla incluida



TARENTO
HLED-1172/S

LUZ BLANCA NEUTRA
○ 4 000 K

Lumens: **240 lm**
Potencia: **3 W**
Volts: **127 V ~**

IRC: **80**
Vida útil: **15 000 h**
Ángulo: **180 °**
IP: **45**
Tipo de base: **GX53**
Tipo de lámpara: **GX53-LED/3W/40 (Incluida)**
Atenuable: **No**

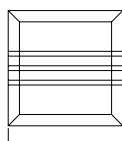

140x140mm



54mm



TENERIFE
HLED-1170/S

LUZ BLANCA NEUTRA
○ 4 000 K

Lumens: **240 lm**
Potencia: **3 W**
Volts: **127 V ~**

Terminado: **Satinado**
IRC: **80**
Vida útil: **15 000 h**
Ángulo: **180 °**
IP: **45**
Tipo de base: **GX53**
Tipo de lámpara: **GX53-LED/3W/40 (Incluida)**
Atenuable: **No**

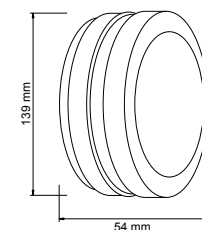

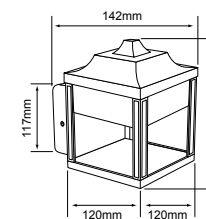

OXALIS
FTL-LED/008/30/N

LUZ SUAVE CÁLIDA
● 3 000 K

Lumens: **330 lm**
Potencia: 9 W
Volts: 100-127 V ~

Terminado: **Negro**
IRC: 80
Vida útil: **20 000 h**
Ángulo: 87°
IP: 44
Tipo de lámpara: LED (Integrado)
Atenuable: No

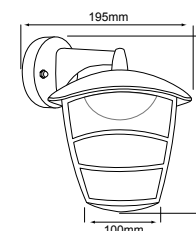

RANGÚN I
FTL-LED/004/N

LUZ BLANCA NEUTRA
○ 4 000 K

Lumens: **350 lm**
Potencia: 10 W
Volts: 100-240 V ~

Terminado: **Negro**
IRC: 80
Vida útil: **20 000 h**
Ángulo: 140°
IP: 44
Tipo de lámpara: LED (Integrado)
Atenuable: No

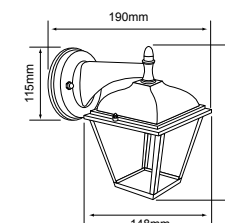

HEDERA
FTL-LED/007/30/N

LUZ SUAVE CÁLIDA
● 3 000 K

Lumens: **400 lm**
Potencia: 8.5 W
Volts: 100-127 V ~

Terminado: **Negro**
IRC: 80
Vida útil: **20 000 h**
Ángulo: 105°
IP: 44
Tipo de lámpara: LED (Integrado)
Atenuable: No

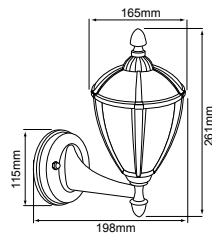

RALEIGH
FTL-LED/003/N

LUZ BLANCA NEUTRA
○ 4 000 K

Lumens: **300 lm**
Potencia: **9 W**
Volts: **100-240 V ~**

Terminado: **Negro**
IRC: **80**
Vida útil: **20 000 h**
Ángulo: **156 °**
IP: **45**
Tipo de lámpara: **LED (Integrado)**
Atenuable: **No**

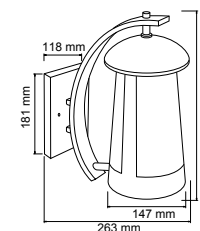

RABAT
FTL-LED/002/11W/N

LUZ BLANCA NEUTRA
○ 4 000 K

Lumens: **700 lm**
Potencia: **11 W**
Volts: **100-127 V ~**

Terminado: **Negro**
IRC: **80**
Vida útil: **30 000 h**
Ángulo: **156 °**
IP: **45**
Tipo de lámpara: **LED (Integrado)**
Atenuable: **No**



NUEVO
LICITA
24ESLED540MV65G

LUZ DE DÍA
● 6 500 K

Lumens: **1250 lm**
Potencia: 24 W
Volts: 100-240 V ~

Terminado: Gris
IRC: 80
Vida útil: **15 000 h**
Ángulo: 90 °
IP: 54
Tipo de lámpara: LED (Integrado)
Atenuable: No
Incluye fotocelda

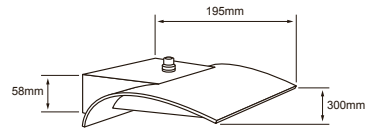

LUMUS
ESLED-4002/F

LUZ DE DÍA
● 5 000 K

Lumens: **3 900 lm**
Potencia: 47 W
Volts: 100-127 V ~

Terminado: Gris
IRC: 80
Vida útil: **20 000 h**
Ángulo: 59°
IP: 54
Tipo de lámpara: LED (Integrado)
Atenuable: No
Incluye fotocelda

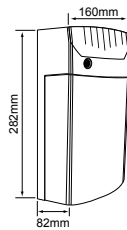

VITORIO II
14SLED20MV65CF

LUZ DE DÍA
● 6 500 K

Lumens: **1 300 lm**
Potencia: 14 W
Volts: 100-240 V ~

Terminado: Café
IRC: 80
Vida útil: **15 000 h**
Ángulo: 220 °
IP: 45
Tipo de base: E27
Tipo de lámpara: LED 14 W (Incluida)
Atenuable: No

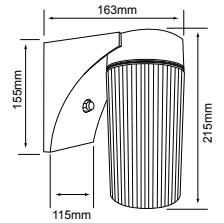

VICENZA II
14GLLED20MV65CF

LUZ DE DÍA
● 6 500 K

Lumens: **1 300 lm**
Potencia: 14 W
Volts: 100-240 V ~

Terminado: Café
IRC: 80
Vida útil: **15 000 h**
Ángulo: 220 °
IP: 45
Tipo de base: E27
Tipo de lámpara: LED 14 W (Incluida)
Atenuable: No

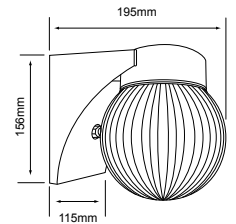

VALETA
SLED-11

LUZ BLANCA NEUTRA
● 4 000 K

Lumens: **270 lm**
Potencia: 3 W
Volts: 127 V ~

Terminado: Negro
IRC: 80
Vida útil: **15 000 h**
Ángulo: 110 °
IP: 45
Tipo de base: GX53
Tipo de lámpara: GX53-LED/3W/40 (Incluida)
Atenuable: No

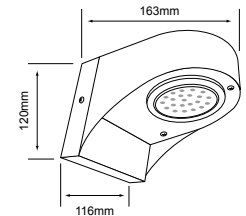

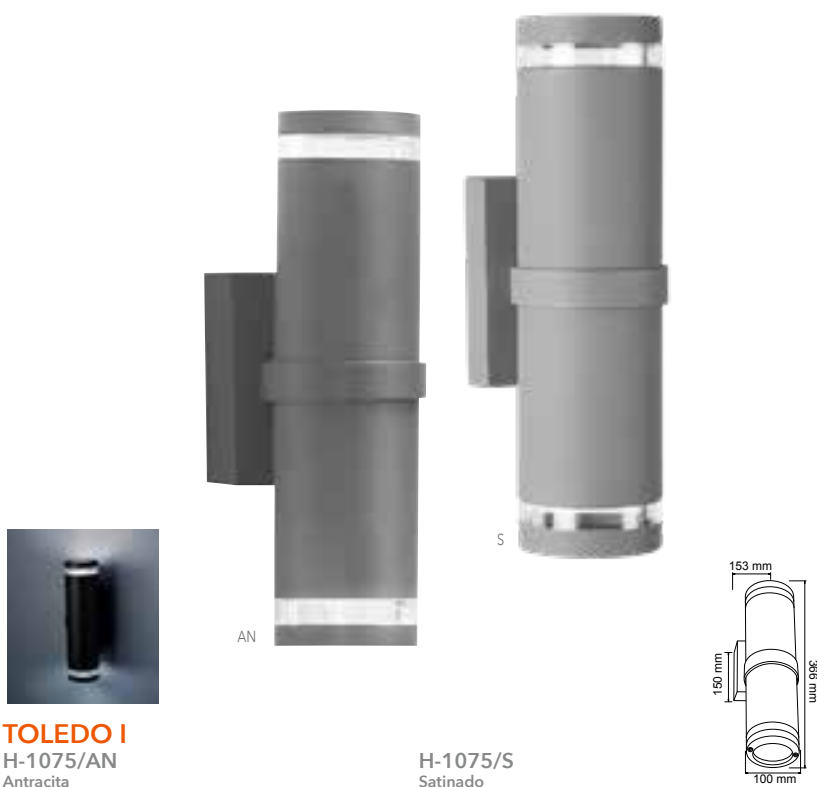

TOLEDO I
H-1075/AN
Antracita

H-1075/S
Satinado

Potencia máx.: 120 W
Volts: 100-240 V ~

IP: 45
Tipo de base: E27 x 2
Tipo de lámpara: Opcional (No incluida)

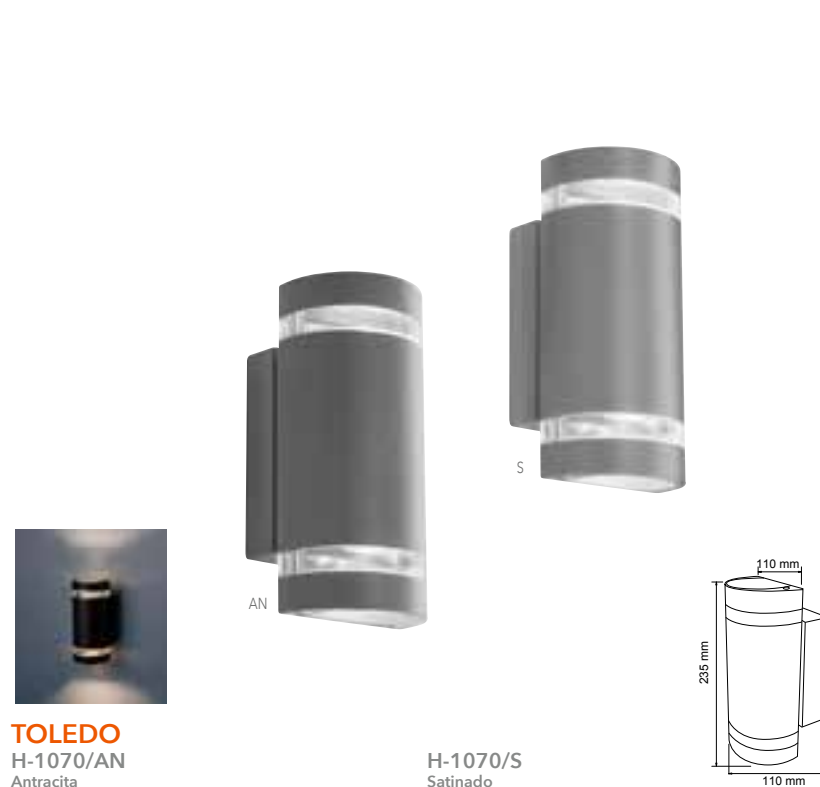

TOLEDO
H-1070/AN
Antracita

H-1070/S
Satinado

Potencia máx.: 100 W
Volts: 100-240 V ~

IP: 45
Tipo de base: GU10 x 2
Tipo de lámpara: GU10 x 2 (No incluida)



URBINO
H-945/B
Blanco

H-945/S
Satinado

Potencia máx.: 60 W
Volts: 100-240 V ~

IP: 45
Tipo de base: E27
Tipo de lámpara: Opcional (No incluida)

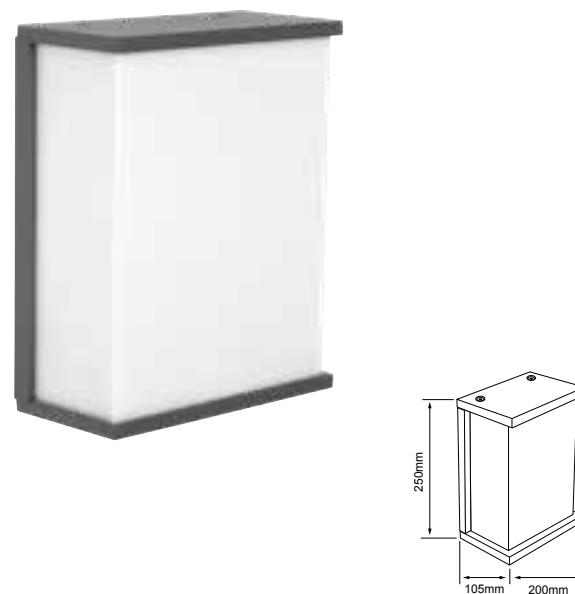

TOULON III
20H1175MVS

Potencia máx.: 60 W
Volts: 100-240 V ~

IP: 44
Tipo de base: E27
Tipo de lámpara: Opcional (No incluida)



RAUCH
H-1151/AN

Potencia máx.: 60 W
Volts: 100-240 V ~

Terminado: Antracita
IP: 45
Tipo de base: E27
Tipo de lámpara: Opcional (No incluida)

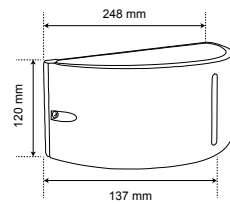

CITRON
H-1180/S

Potencia máx.: 60 W
Volts: 100-240 V ~

Terminado: Satinado
IP: 45
Tipo de base: E27
Tipo de lámpara: Opcional (No incluida)

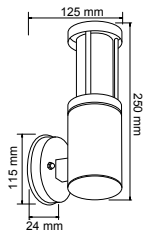

VENECIA
H-1050/S

Potencia máx.: 60 W
Volts: 100-240 V ~

Terminado: Satinado
IP: 45
Tipo de base: E27
Tipo de lámpara: Opcional (No incluida)

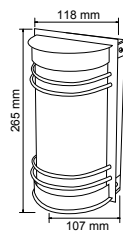

TREVISO
H-1085/S

Potencia máx.: 60 W
Volts: 100-240 V ~

Terminado: Satinado
IP: 45
Tipo de base: E27
Tipo de lámpara: Opcional (No incluida)

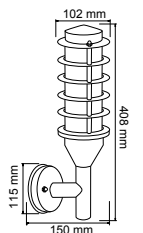



B



B



S

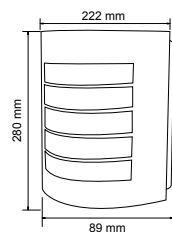

S

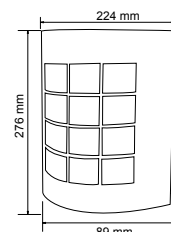

TURIN
H-800/B
Blanco

Potencia máx.: 60 W
Volts: 100-240 V ~

H-800/S
Satinado

IP: 45
Tipo de base: E27
Tipo de lámpara: Opcional (No incluida)

TURIN I
H-810/B
Blanco

Potencia máx.: 60 W
Volts: 100-240 V ~

H-810/S
Satinado

IP: 45
Tipo de base: E27
Tipo de lámpara: Opcional (No incluida)

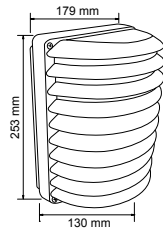

TIRANA H-1130/S

Potencia máx.: 60 W
Volts: 100-240 V ~

Terminado: **Satinado**
IP: 45
Tipo de base: E27
Tipo de lámpara: **Opcional (No incluida)**

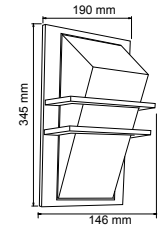

TALIN H-1190/S

Potencia máx.: 60 W
Volts: 100-240 V ~

Terminado: **Satinado**
IP: 45
Tipo de base: E27
Tipo de lámpara: **Opcional (No incluida)**

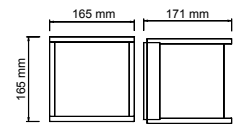

TOULON H-1200/S

Potencia máx.: 60 W
Volts: 100-240 V ~

Terminado: **Satinado**
IP: 45
Tipo de base: E27
Tipo de lámpara: **Opcional (No incluida)**

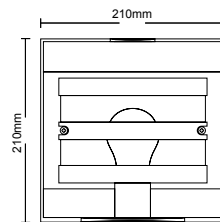

TRENTO H-1060/S

Potencia máx.: 60 W
Volts: 100-240 V ~

Terminado: **Satinado**
IP: 45
Tipo de base: E27
Tipo de lámpara: **Opcional (No incluida)**

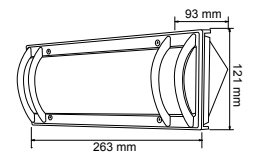

TREZZA H-1090/B

Potencia máx.: 60 W
Volts: 100-240 V ~

Terminado: **Blanco**
IP: 45
Tipo de base: E27
Tipo de lámpara: **Opcional (No incluida)**

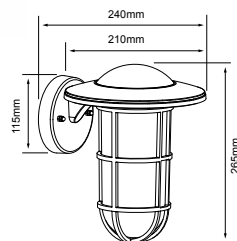

ARA
60FTL8205MVCF

Potencia máx.: 60 W
Volts: 100-240 V ~

Terminado: Café
Tipo de base: E27
Tipo de lámpara: Opcional (No incluida)
IP: 44



B



AQUARIUS
60FTL8203MVB Blanco

Potencia máx.: 60 W
Volts: 100-240 V ~



N

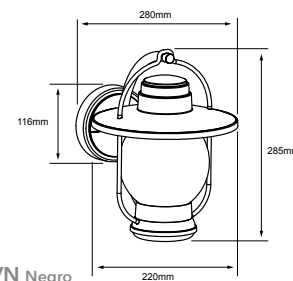

60FTL8203MVN Negro

Tipo de base: E27
Tipo de lámpara: Opcional (No incluida)
IP: 44



B



BIXA
FTL-8202/B
Blanco

Potencia máx.: 60 W
Volts: 100-240 V ~



N

FTL-8202/N
Negro

Tipo de base: E27
Tipo de lámpara: Opcional (No incluida)
IP: 44

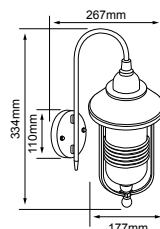

B



AURIGA
60FTL8204MVB Blanco

Potencia máx.: 60 W
Volts: 100-240 V ~



N

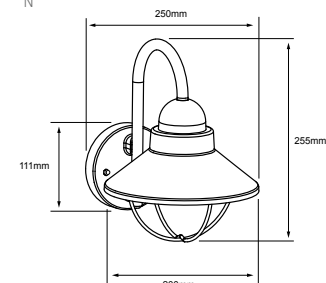

60FTL8204MVN Negro

Tipo de base: E27
Tipo de lámpara: Opcional (No incluida)
IP: 44

LA CORROSIÓN, PRINCIPAL ENEMIGO A VENCER

El ambiente de las Zonas Costeras contiene un alto nivel de salinidad que deterioran los metales de las luminarias, pero Tecnolite tiene la solución con materiales de una gran resistencia hacia la oxidación.

La cercanía del mar ha sido siempre un enorme desafío para la iluminación. Los puntos de luz en andadores, hoteles, muelles y hogares están expuestos a un ambiente húmedo y salino con un poder de corrosión intenso.

El veloz desgaste generado por estas condiciones compromete la seguridad estructural y el funcionamiento eléctrico, lo que ocasiona averías frecuentes y alteraciones en el rendimiento.

Sin embargo, Tecnolite ha pensado en la solución para las necesidades en las Zonas Costeras por lo que pone a su disposición una variedad de productos con materiales CERO CORROSIÓN que resaltarán sus ambientes exteriores al máximo.

Estos materiales pasan por procesos especializados y pruebas que aseguran una excelente calidad en sus componentes, ofreciendo beneficios como:

- Alta resistencia a la corrosión
- Resistencia a solventes químicos
- Mantenimiento mínimo
- Protección extra para tecnologías LED
- Garantía de 1 a 5 años según tecnología



ACERO
Después de 3 años



ALUMINIO
Después de 10 años



TECNOLITE
Después de 15 años

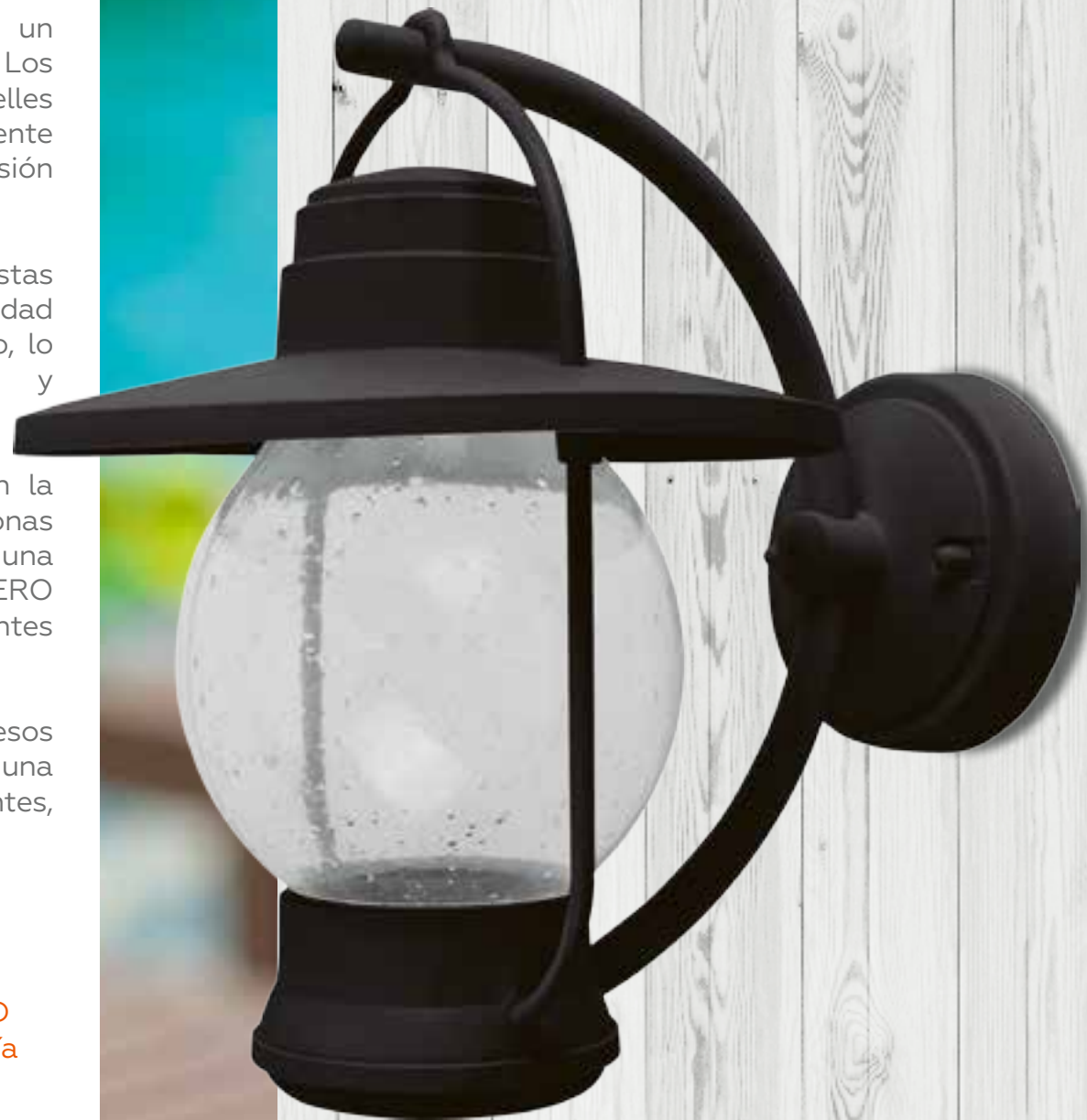

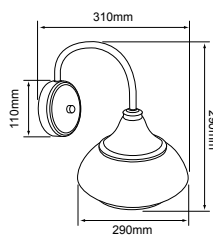

SADIRA
FTL-3425/BA

Potencia máx.: 60 W
Volts: 100-240 V ~

Terminado: **Bronce Antiguo**
IP: 44
Tipo de base: E27
Tipo de lámpara: **Opcional (No incluida)**

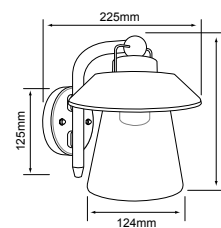

SPICA
FTL-3423/BA

Potencia máx.: 60 W
Volts: 100-240 V ~

Terminado: **Bronce Antiguo**
IP: 44
Tipo de base: E27
Tipo de lámpara: **Opcional (No incluida)**

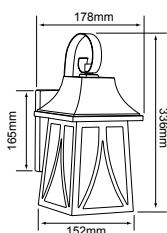

ANTONELLA
FTL-3421/N

Potencia máx.: 60 W
Volts: 100-240 V ~

Terminado: **Negro**
IP: 44
Tipo de base: E27
Tipo de lámpara: **Opcional (No incluida)**

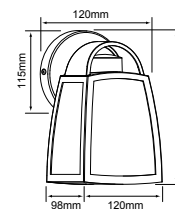

SIRIO
20FTL3424MVN

Potencia máx.: 60 W
Volts: 100-240 V ~

Terminado: **Negro**
IP: 44
Tipo de base: E27
Tipo de lámpara: **Opcional (No incluida)**

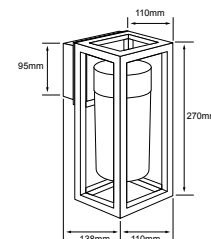

VEGA II
60FTL3429MVN

Potencia: 60 W
Volts: 100-240 V ~

Terminado: **Negro**
IP: 44
Tipo de lámpara: **Opcional (No incluida)**

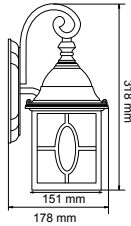

POZNA
FTL-3420/S

Potencia máx.: 60 W
Volts: 100-240 V ~

Terminado: Satinado
IP: 44
Tipo de base: E27
Tipo de lámpara: Opcional (No incluida)

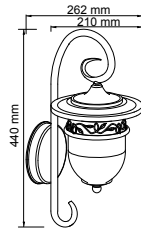

REVENNA
FTL-3330/BA

Potencia máx.: 60 W
Volts: 100-240 V ~

Terminado: Bronce Antiguo
IP: 44
Tipo de base: E27
Tipo de lámpara: Opcional (No incluida)

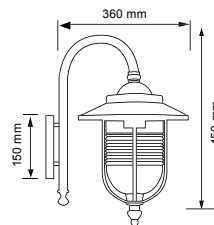

RIMNI
FTL-1402/BA

Potencia máx.: 60 W
Volts: 100-240 V ~

Terminado: Bronce Antiguo
IP: 44
Tipo de base: E27
Tipo de lámpara: Opcional (No incluida)

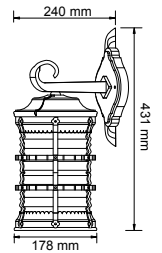

RUSO
FTL-4110/BA

Potencia máx.: 60 W
Volts: 100-240 V ~

Terminado: Bronce Antiguo
IP: 44
Tipo de base: E27
Tipo de lámpara: Opcional (No incluida)

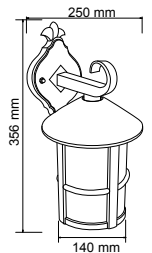

SARAJEVO
FTL-3340/BA

Potencia máx.: 60 W
Volts: 100-240 V ~

Terminado: Bronce Antiguo
IP: 44
Tipo de base: E27
Tipo de lámpara: Opcional (No incluida)

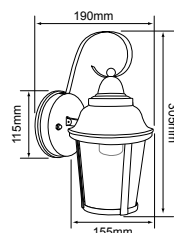

ALLEGRA
FTL-3422/N

Potencia máx.: 60 W
Volts: 100-240 V ~

Terminado: Negro
IP: 44
Tipo de base: E27
Tipo de lámpara: Opcional (No incluida)

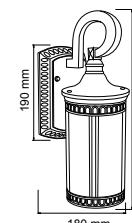

PETRA
FTL-3200/BA

Potencia máx.: 60 W
Volts: 100-240 V ~

Terminado: Bronce Antiguo
IP: 44
Tipo de base: E27
Tipo de lámpara: Opcional (No incluida)

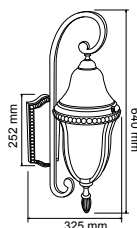

ROCCA
FTL-3000/BA

Potencia máx.: 60 W
Volts: 100-240 V ~

Terminado: Bronce Antiguo
IP: 44
Tipo de base: E27
Tipo de lámpara: Opcional (No incluida)

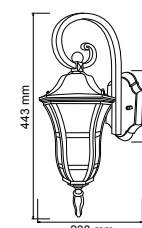

RONDA
FTL-3800/BA

Potencia máx.: 60 W
Volts: 100-240 V ~

Terminado: Bronce Antiguo
IP: 44
Tipo de base: E27
Tipo de lámpara: Opcional (No incluida)

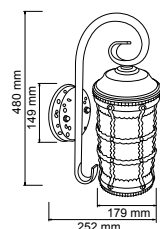

TERME
FTL-4100/BA

Potencia máx.: 60 W
Volts: 100-240 V ~

Terminado: Bronce Antiguo
IP: 44
Tipo de base: E27
Tipo de lámpara: Opcional (No incluida)

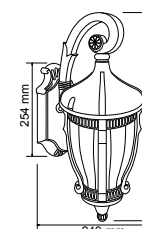

SEGOVIA
FTL-3300/BA

Potencia máx.: 60 W
Volts: 100-240 V ~

Terminado: Bronce Antiguo
IP: 44
Tipo de base: E27
Tipo de lámpara: Opcional (No incluida)

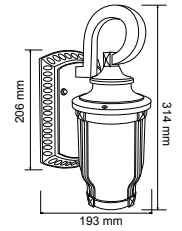

SABINO
FTL-6000/BA

Potencia máx.: 60 W
Volts: 100-240 V ~

Terminado: **Bronce Antiguo**
IP: 44
Tipo de base: E27
Tipo de lámpara: **Opcional (No incluida)**

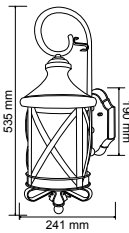

ROMA
FTL-4000/BA

Potencia máx.: 120 W
Volts: 100-240 V ~

Terminado: **Bronce Antiguo**
IP: 44
Tipo de base: E27 x 2
Tipo de lámpara: **Opcional (No incluida)**

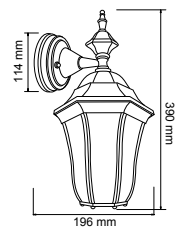

SAN JUAN I
FTL-6005D/BA

Potencia máx.: 60 W
Volts: 100-240 V ~

Terminado: **Bronce Antiguo**
IP: 44
Tipo de base: E27
Tipo de lámpara: **Opcional (No incluida)**

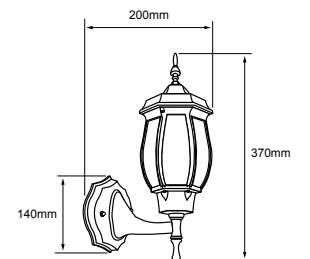

SALERMO
FTL-6002/B
Blanco

FTL-6002/CF
Café

FTL-6002/N
Negro

FTL-6002/V
Verde

Potencia máx.: 60 W
Volts: 100-240 V ~

IP: 44
Tipo de base: E27

Tipo de lámpara: **Opcional (No incluida)**



B



N

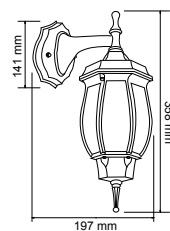

SALERMO I

FTL-6002D/B
Blanco

FTL-6002D/N
Negro

Potencia máx.: 60 W
Volts: 100-240 V ~

IP: 44
Tipo de base: E27
Tipo de lámpara: Opcional (No incluida)



B



N

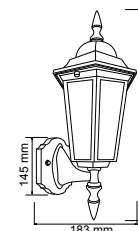

SAN REMO

FTL-7055/B
Blanco

FTL-7055/N
Negro

Potencia máx.: 60 W
Volts: 100-240 V ~

IP: 44
Tipo de base: E27
Tipo de lámpara: Opcional (No incluida)



B



CF



N

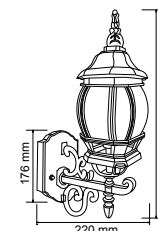

SIENA

FTL-7355/B
Blanco

FTL-7355/CF
Café

FTL-7355/N
Negro

Potencia máx.: 60 W
Volts: 100-240 V ~

IP: 44
Tipo de base: E27

Tipo de lámpara: Opcional (No incluida)

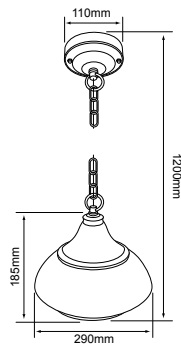

GIEDI
FTL-3426/BA

Potencia máx.: 60 W
Volts: 100-240 V ~

Terminado: Bronce Antiguo
IP: 44
Tipo de base: E27
Tipo de lámpara: Opcional (No incluida)

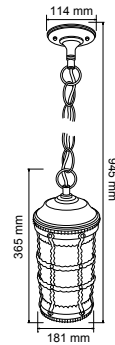

TERME I
FTL-4101/BA

Potencia máx.: 60 W
Volts: 100-240 V ~

Terminado: Bronce Antiguo
IP: 44
Tipo de base: E27
Tipo de lámpara: Opcional (No incluida)

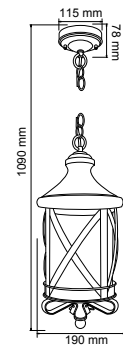

ROMA II
FTL-4001/BA

Potencia máx.: 120 W
Volts: 100-240 V ~

Terminado: Bronce Antiguo
IP: 44
Tipo de base: E27 x 2
Tipo de lámpara: Opcional (No incluida)

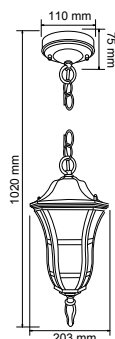

RONDA I
FTL-3801/BA

Potencia máx.: 60 W
Volts: 100-240 V ~

Terminado: **Bronce Antiguo**
IP: 44
Tipo de base: E27
Tipo de lámpara: **Opcional (No incluida)**

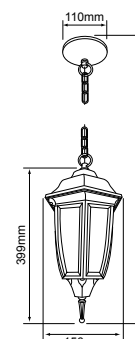

SANTIAGO
FTL-6003/N

Potencia máx.: 60 W
Volts: 100-240 V ~

Terminado: **Negro**
IP: 44
Tipo de base: E27
Tipo de lámpara: **Opcional (No incluida)**



B



CF



N

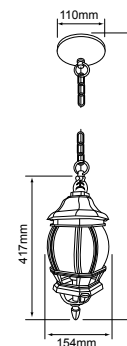

SIENA II
FTL-7356/B
Blanco

Potencia máx.: 60 W
Volts: 100-240 V ~

FTL-7356/CF
Café

IP: 44
Tipo de base: E27

FTL-7356/N
Negro

Tipo de lámpara: **Opcional (No incluida)**

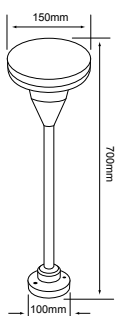

ADHARA II

HLED-1175/30/G

LUZ SUAVE CÁLIDA
● 3 000 K

Lumens: **700 lm**
Potencia: **10 W**
Volts: **100-240 V ~**

Terminado: **Gris**
IRC: **80**
Vida útil: **15 000 h**
Ángulo: **106°**
IP: **65**
Tipo de lámpara: **LED (Integrado)**
Atenuable: **No**

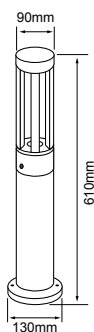

DRACO
09HLED1203MV30N

LUZ SUAVE CÁLIDA
● 3 000 K
Lumens: 418 lm
Potencia: 9 W
Volts: 100-240 V ~

Terminado: **Negro**
IRC: **80**
Vida útil: **30 000 h**
Ángulo: **115 °**
IP: **54**
Tipo de lámpara: **LED (integrado)**
Atenuable: **No**

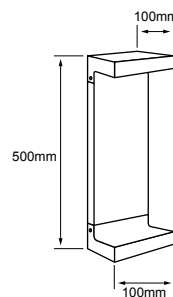

COMA
09HLED429MV30N

LUZ SUAVE CÁLIDA
● 3 000 K
Lumens: 507 lm
Potencia: 9 W
Volts: 100-240 V ~

Terminado: **Negro**
IRC: **80**
Vida útil: **30 000 h**
Ángulo: **38 °**
IP: **54**
Tipo de lámpara: **LED (integrado)**
Atenuable: **No**

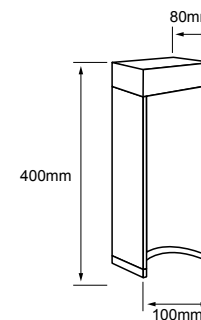

EQUULEUS
09HLED431MV30N

LUZ SUAVE CÁLIDA
● 3 000 K
Lumens: 349 lm
Potencia: 9 W
Volts: 100-240 V ~

Terminado: **Negro**
IRC: **80**
Vida útil: **30 000 h**
Ángulo: **102 °**
IP: **54**
Tipo de lámpara: **LED (integrado)**
Atenuable: **No**

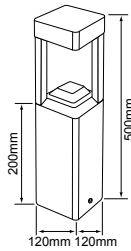

POLIS I

10HLED1205MV30N

LUZ SUAVE CÁLIDA
● 3 000 K

Lumens: **360 lm**
Potencia: **10 W**
Volts: **100-240 V ~**

Terminado: **Negro**
IRC: **80**
Vida útil: **15 000 h**
Ángulo: **350 °**
IP: **44**
Tipo de lámpara: **LED (Integrado)**
Atenuable: **No**

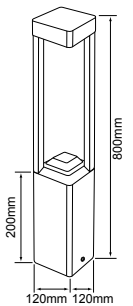

POLIS II

10HLED1208MV30N

LUZ SUAVE CÁLIDA
● 3 000 K

Lumens: **360 lm**
Potencia: **10 W**
Volts: **100-240 V ~**

Terminado: **Negro**
IRC: **80**
Vida útil: **15 000 h**
Ángulo: **350 °**
IP: **44**
Tipo de lámpara: **LED (Integrado)**
Atenuable: **No**

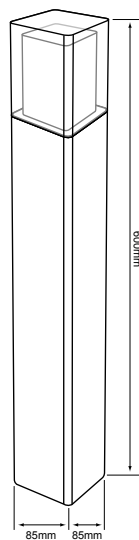

OBELIX III
HLED-003/N/30

LUZ SUAVE CÁLIDA
● 3 000 K

Lumens: **770 lm**
Potencia: **13 W**
Volts: **100-240 V ~**

Terminado: **Negro**
IRC: **80**
Vida útil: **30 000 h**
Ángulo: **120 °**
IP: **65**
Tipo de lámpara: **LED (Integrado)**
Atenuable: **No**

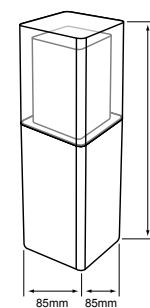

OBELIX IV
HLED-004/N/30

LUZ SUAVE CÁLIDA
● 3 000 K

Lumens: **810 lm**
Potencia: **13 W**
Volts: **100-240 V ~**

Terminado: **Negro**
IRC: **80**
Vida útil: **30 000 h**
Ángulo: **120 °**
IP: **65**
Tipo de lámpara: **LED (Integrado)**
Atenuable: **No**

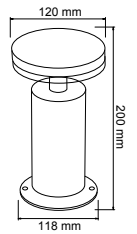

ALORA I

HLED-204/7W/30/S

LUZ SUAVE CÁLIDA
● 3 000 K

Lumens: **260 lm**
Potencia: **7 W**
Volts: **100-240 V ~**

Terminado: **Satinado**
IRC: **80**
Vida útil: **30 000 h**
Ángulo: **120 °**
IP: **45**
Tipo de lámpara: **LED (Integrado)**
Atenuable: **No**

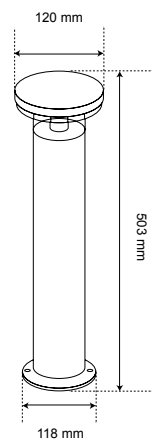

ALORA

HLED-205/7W/30/S

LUZ SUAVE CÁLIDA
● 3 000 K

Lumens: **260 lm**
Potencia: **7 W**
Volts: **100-240 V ~**

Terminado: **Satinado**
IRC: **80**
Vida útil: **30 000 h**
Ángulo: **120 °**
IP: **45**
Tipo de lámpara: **LED (Integrado)**
Atenuable: **No**



SPICA II
H-3423/BA
Bronce Antiguo

Potencia máx.: 60 W
Volts: 100-240 V ~

Terminado: Bronce Antiguo
IP: 44
Tipo de base: E27
Tipo de lámpara: Opcional (No incluida)

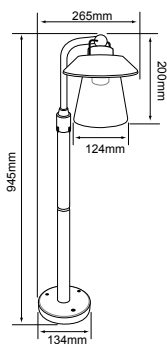

ALPINO
H-425/S

Potencia máx.: 60 W
Volts: 100-240 V ~

Terminado: Satinado
IP: 45
Tipo de base: E27
Tipo de lámpara: Opcional (No incluida)

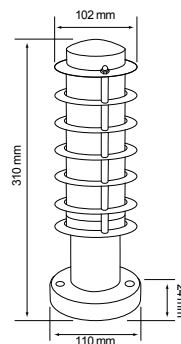

AMSTERDAM
H-430/S

Potencia máx.: 60 W
Volts: 100-240 V ~

Terminado: Satinado
IP: 45
Tipo de base: E27
Tipo de lámpara: Opcional (No incluida)

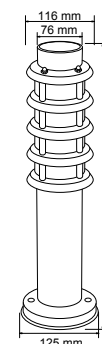

ALTAMIRA
H-450/S

Potencia máx.: 60 W
Volts: 100-240 V ~

Terminado: Satinado
IP: 67
Tipo de base: E27
Tipo de lámpara: Opcional (No incluida)

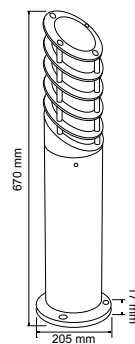

ANKARA
H-414/S

Potencia máx.: 60 W
Volts: 100-240 V ~

Terminado: Satinado
IP: 45
Tipo de base: E27
Tipo de lámpara: Opcional (No incluida)

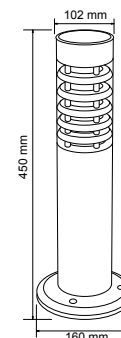



N



S

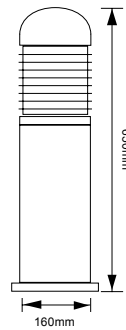

ALMODOVAR
H-410/N
Negro

Potencia máx.: 60 W
Volts: 100-240 V ~

IP: 45
Tipo de base: E27
Tipo de lámpara: Opcional (No incluida)



ANTEQUERA I
HFV-820/N

Potencia máx.: 60 W
Volts: 100-240 V ~

Terminado: Negro
IP: 45
Tipo de base: E27
Tipo de lámpara: Opcional (No incluida)

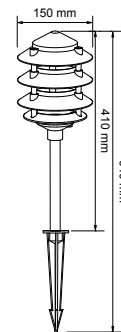

CF



V

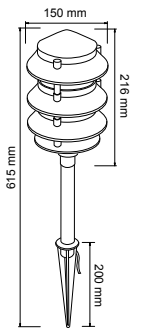

ANTEQUERA
H-820/CF
Café

Potencia máx.: 60 W
Volts: 100-240 V ~

H-820/V
Verde
IP: 45
Tipo de base: E27
Tipo de lámpara: Opcional (No incluida)

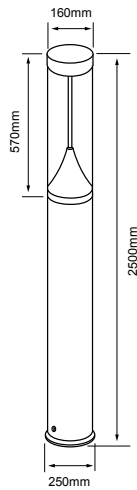

FORNAX
30HLED2500MV30N

LUZ SUAVE CÁLIDA
● 3 000 K
Lumens: **2 344 lm**
Potencia: 30 W
Volts: 100 - 277 V ~

Terminado: **Negro**
IRC: **80**
Vida útil: **30 000 h**
Ángulo: **180 °**
Tipo de lámpara: **LED (integrado)**
IP: **65**
Incluye herrajes de instalación

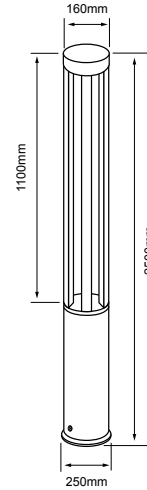

HOROLOGIUM
25HLED2501MV30N

LUZ SUAVE CÁLIDA
● 3 000 K
Lumens: **2 120 lm**
Potencia: 25 W
Volts: 100 - 277 V ~

Terminado: **Negro**
IRC: **80**
Vida útil: **30 000 h**
Ángulo: **65 °**
Tipo de lámpara: **LED (integrado)**
IP: **65**
Incluye herrajes de instalación





CF



N

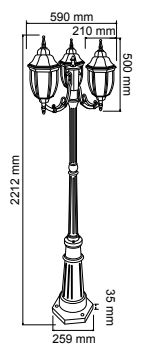

BADALONA
PFT-6004-3/CF
Café

Potencia máx.: 180 W
Volts: 100-240 V ~

PFT-6004-3/N
Negro

IP: 45
Tipo de base: E27 x 3
Tipo de lámpara: Opcional (No incluida)

EXTERIOR ACENTO

VIVE UNA NUEVA ERA CON
ACENTOS DE LUZ QUE DESTACAN TUS MOMENTOS

tecnolite®
LA LUZ ES TUYA



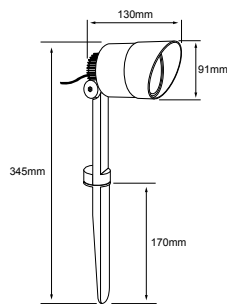

ARCTURUS
6HLED757V30G

LUZ SUAVE CÁLIDA
● 3 000 K

Lumens: **389 lm**
Potencia: 6 W
Volts: 127 V ~

Terminado: **Gris**
IRC: 80
Vida útil: **20 000 h**
Ángulo: 96 °
IP: 54
Tipo de lámpara: LED (Integrado)
Atenuable: No

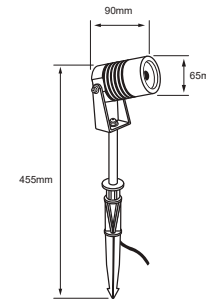

NUEVO
LIESMA
09HLED752MV30N

LUZ SUAVE CÁLIDA
● 3 000 K

Lumens: **775 lm**
Potencia: 9 W
Volts: 100-240 V ~

Terminado: **Negro**
IRC: 80
Vida útil: **30 000 h**
Ángulo: 28 °
IP: 65
Tipo de lámpara: LED (Integrado)
Atenuable: No

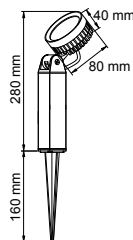

BENDIN
HLED-776/6W/30

LUZ SUAVE CÁLIDA
● 3 000 K

Lumens: **350 lm**
Potencia: 6 W
Volts: 100-240 V ~

Terminado: **Gris**
IRC: 80
Vida útil: **20 000 h**
Ángulo: 25 °
IP: 65
Tipo de lámpara: LED (Integrado)
Atenuable: No
Incluye estaca

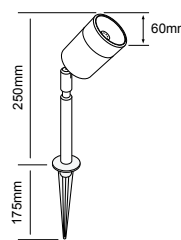

BURSERA
HLED-756/S

LUZ SUAVE CÁLIDA
● 3 000 K

Lumens: **300 lm**
Potencia: 4,5 W
Volts: 127 V ~

Terminado: **Satin**
IRC: 80
Vida útil: **20 000 h**
Ángulo: 49 °
IP: 44
Tipo de lámpara: LED (Integrado)
Atenuable: No
Incluye estaca

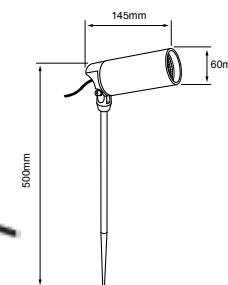

KRAZ
12HLED751MV30N

LUZ SUAVE CÁLIDA
● 3 000 K

Lumens: **760 lm**
Potencia: 12 W
Volts: 100-240 V ~

Terminado: **Negro / Oro**
IRC: 80
Vida útil: **30 000 h**
Ángulo: 24 °
IP: 65
Tipo de lámpara: LED (Integrado)
Atenuable: No

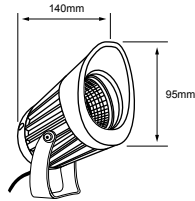

LYNX I

10HLED762MV30N

LUZ SUAVE CÁLIDA
● 3 000 K

Lumens: **713 lm**
Potencia: **10 W**
Volts: **100-240 V ~**

Terminado: **Negro**
IRC: **80**
Vida útil: **30 000 h**
Ángulo: **27 °**

IP: **65**
Tipo de lámpara: **LED (integrado)**
Atenuable: **No**
Incluye estaca

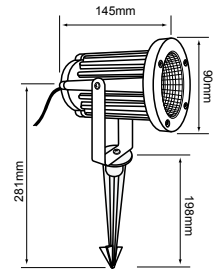

BILBAU I

HLED-755/N

LUZ BLANCA NEUTRA
○ 4 000 K

Lumens: **500 lm**
Potencia: **8 W**
Volts: **100-240 V ~**

Terminado: **Negro**
IRC: **70**
Vida útil: **15 000 h**
Ángulo: **40 °**
IP: **65**
Tipo de lámpara: **LED (Integrado)**
Atenuable: **No**
Incluye estaca

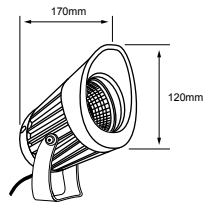

LYNX II

20HLED763MV30N

LUZ SUAVE CÁLIDA
● 3 000 K

Lumens: **1 740 lm**
Potencia: **20 W**
Volts: **100-240 V ~**

Terminado: **Negro**
IRC: **80**
Vida útil: **30 000 h**
Ángulo: **23 °**
IP: **65**
Tipo de lámpara: **LED (integrado)**
Atenuable: **No**
Incluye estaca

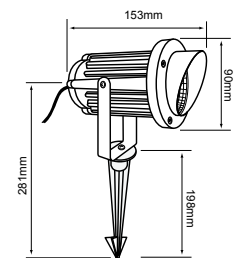

BILBAU II

HLED-760/N

LUZ BLANCA NEUTRA
○ 4 000 K

Lumens: **500 lm**
Potencia: **8 W**
Volts: **100-240 V ~**

Terminado: **Negro**
IRC: **70**
Vida útil: **15 000 h**
Ángulo: **40 °**
IP: **65**
Tipo de lámpara: **LED (Integrado)**
Atenuable: **No**
Incluye estaca

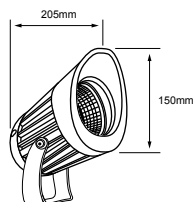

LYNX III

30HLED764MV30N

LUZ SUAVE CÁLIDA
● 3 000 K

Lumens: **1 899 lm**
Potencia: **30 W**
Volts: **100-240 V ~**

Terminado: **Negro**
IRC: **80**
Vida útil: **30 000 h**
Ángulo: **24 °**

IP: **65**
Tipo de lámpara: **LED (integrado)**
Atenuable: **No**
Incluye estaca

LUZ BLANCA NEUTRA
○ 4 000 K

Lumens: **500 lm**
Potencia: **8 W**
Volts: **100-240 V ~**

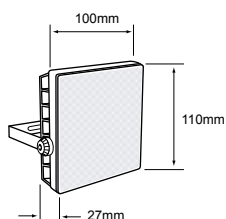

LUMIERE I

LQ-LED/001/30
LUZ SUAVE CÁLIDA
● 3 000 K

LQ-LED/001/65
LUZ DE DÍA
● 6 500 K

Lumens: **800 lm**
Potencia: **10 W**
Volts: **100-240 V ~**

Terminado: **Negro**
IRC: **80**
Vida útil: **25 000 h**
Ángulo: **90 °**

IP: **65**
Tipo de lámpara: **LED (Integrado)**
Atenuable: **No**

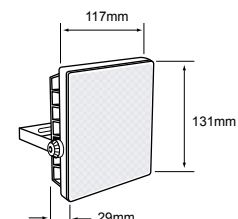

LUMIERE II

LQ-LED/002/30
LUZ SUAVE CÁLIDA
● 3 000 K

LQ-LED/002/65
LUZ DE DÍA
● 6 500 K

Lumens: **1 600 lm**
Potencia: **20 W**
Volts: **100-240 V ~**

Terminado: **Negro**
IRC: **80**
Vida útil: **25 000 h**
Ángulo: **90 °**

IP: **65**
Tipo de lámpara: **LED (Integrado)**
Atenuable: **No**

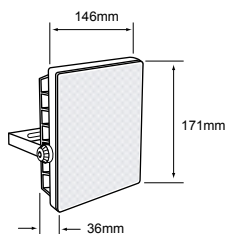

LUMIERE III

LQ-LED/003/30
LUZ SUAVE CÁLIDA
● 3 000 K

LQ-LED/003/65
LUZ DE DÍA
● 6 500 K

Lumens: **2 400 lm**
Potencia: **30 W**
Volts: **100-240 V ~**

Terminado: **Negro**
IRC: **80**
Vida útil: **25 000 h**
Ángulo: **90 °**
IP: **65**
Tipo de lámpara: **LED (Integrado)**
Atenuable: **No**

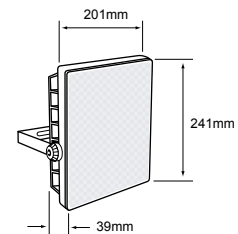

LUMIERE IV

LQ-LED/004/30
LUZ SUAVE CÁLIDA
● 3 000 K

LQ-LED/004/65
LUZ DE DÍA
● 6 500 K

Lumens: **4 000 lm**
Potencia: **50 W**
Volts: **100-240 V ~**

Terminado: **Negro**
IRC: **80**
Vida útil: **25 000 h**
Ángulo: **90 °**
IP: **65**
Tipo de lámpara: **LED (Integrado)**
Atenuable: **No**

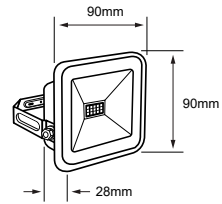
**NUEVO****CYPERUS I**

10LQLEDL30MVN
LUZ SUAVE CÁLIDA
● 3 000 K

Lumens: 1 000 lm
Potencia: 10 W
Volts: 100-240 V ~

10LQLEDL65MVN
LUZ DE DÍA
● 6 500 K

Terminado: Negro
IRC: 80
Vida útil: **30 000 h**
Ángulo: 110 °
IP: 65
Tipo de lámpara: LED (Integrado)
Atenuable: No

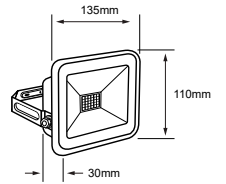
**NUEVO****CYPERUS II**

20LQLEDL30MVN
LUZ SUAVE CÁLIDA
● 3 000 K

Lumens: 1 900 lm
Potencia: 20 W
Volts: 100-240 V ~

20LQLEDL65MVN
LUZ DE DÍA
● 6 500 K

Terminado: Negro
IRC: 80
Vida útil: **30 000 h**
Ángulo: 110 °
IP: 65
Tipo de lámpara: LED (Integrado)
Atenuable: No

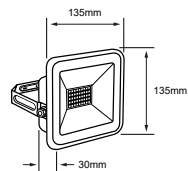
**NUEVO****CYPERUS III**

30LQLEDL30MVN
LUZ SUAVE CÁLIDA
● 3 000 K

Lumens: 3 000 lm
Potencia: 30 W
Volts: 100-240 V ~

30LQLEDL65MVN
LUZ DE DÍA
● 6 500 K

Terminado: Negro
IRC: 80
Vida útil: **30 000 h**
Ángulo: 110 °
IP: 65
Tipo de lámpara: LED (Integrado)
Atenuable: No

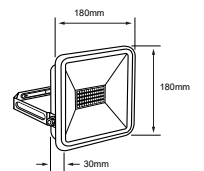
**NUEVO****CYPERUS IV**

50LQLEDL30MVN
LUZ SUAVE CÁLIDA
● 3 000 K
Lumens: 4 750 lm

Potencia: 50 W
Volts: 100-240 V ~

50LQLEDL65MVN
LUZ DE DÍA
● 6 500 K
Lumens: 5 000 lm

Terminado: Negro
IRC: 80
Vida útil: **30 000 h**
Ángulo: 110 °
IP: 65
Tipo de lámpara: LED (Integrado)
Atenuable: No

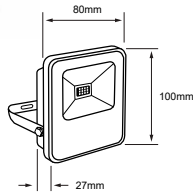

NUEVO

ZIBAL I

10LQLEDT30MVN
LUZ SUAVE CÁLIDA
● 3 000 K

10LQLEDT65MVN
LUZ DE DÍA
● 6 500 K

Lumens: **800 lm**
Potencia: 10 W
Volts: 100-240 V ~

Terminado: Negro
IRC: 80
Vida útil: **25 000 h**
Ángulo: 120 °
IP: 65
Tipo de lámpara: LED (Integrado)
Atenuable: No

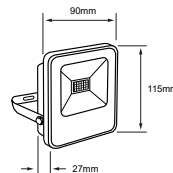

NUEVO

ZIBAL II

20LQLEDT30MVN
LUZ SUAVE CÁLIDA
● 3 000 K

20LQLEDT65MVN
LUZ DE DÍA
● 6 500 K

Lumens: **1 600 lm**
Potencia: 20 W
Volts: 100-240 V ~

Terminado: Negro
IRC: 80
Vida útil: **25 000 h**
Ángulo: 120 °
IP: 65
Tipo de lámpara: LED (Integrado)
Atenuable: No

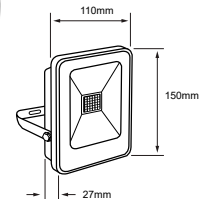

NUEVO

ZIBAL III

30LQLEDT30MVN
LUZ SUAVE CÁLIDA
● 3 000 K

30LQLEDT65MVN
LUZ DE DÍA
● 6 500 K

Lumens: **2 700 lm**
Potencia: 30 W
Volts: 100-240 V ~

Terminado: Negro
IRC: 80
Vida útil: **25 000 h**
Ángulo: 120 °
IP: 65
Tipo de lámpara: LED (Integrado)
Atenuable: No

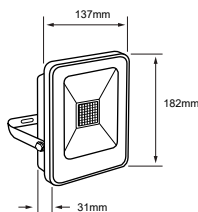

NUEVO

ZIBAL IV

50LQLEDT30MVN
LUZ SUAVE CÁLIDA
● 3 000 K

50LQLEDT65MVN
LUZ DE DÍA
● 6 500 K

Lumens: **4 500 lm**
Potencia: 50 W
Volts: 100-240 V ~

Terminado: Negro
IRC: 80
Vida útil: **25 000 h**
Ángulo: 120 °
IP: 65
Tipo de lámpara: LED (Integrado)
Atenuable: No

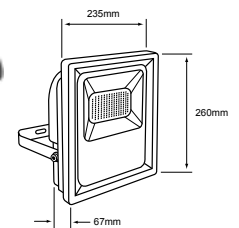

IZAR I

70LQLED30MVN
LUZ SUAVE CÁLIDA
● 3 000 K
Lumens: **5 600 lm**

70LQLED65MVN
LUZ DE DÍA
● 6 500 K
Lumens: **6 000 lm**

Potencia: 70 W
Volts: 100-240 V ~

Terminado: Negro
IRC: 70
Vida útil: **20 000 h**
Ángulo: 110 °
IP: 65
Tipo de lámpara: LED (Integrado)
Atenuable: No



La luz **ÁMBAR** es **MÁS AMIGABLE** con la **VEGETACIÓN** y el entorno



Crea ambientes **CÁLIDOS** y acogedores



Evoca sensación de las lámparas de vapor de sodio, pero con un **MAYOR AHORRO ENERGÉTICO**



LUZ ÁMBAR

ALADFAR I 50LQLEDT18MVN

LUZ ÁMBAR
● 1 800 K

Lumens: **3 000 lm**
Potencia: 50 W
Volts: 100-240 V ~

Terminado: Negro
IRC: 70
Vida útil: **25 000 h**
Ángulo: 90 °
IP: 65
Tipo de lámpara: LED (Integrado)
Incluye: Driver LED
Atenuable: No

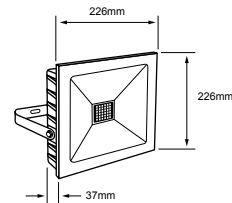

La luz **ÁMBAR** es **MÁS AMIGABLE** con la **VEGETACIÓN** y el entorno



Crea ambientes **CÁLIDOS** y acogedores



Evoca sensación de las lámparas de vapor de sodio, pero con un **MAYOR AHORRO ENERGÉTICO**



LUZ ÁMBAR

ALADFAR II 100LQLEDT18MVN

LUZ ÁMBAR
● 1 800 K

Lumens: **6 000 lm**
Potencia: 100 W
Volts: 100-240 V ~

Terminado: Negro
IRC: 70
Vida útil: **25 000 h**
Ángulo: 90 °
IP: 65
Tipo de lámpara: LED (Integrado)
Incluye: Driver LED
Atenuable: No

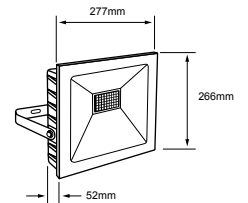

LUZ CÁLIDA

LUZ ÁMBAR



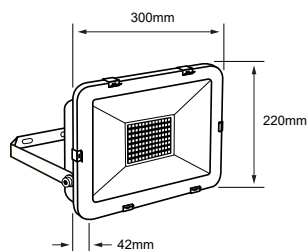

NUEVO
IZAR II
100LQLEDL65MVN
LUZ DE DÍA
● 6 500 K

Lumens: **9 000 lm**
Potencia: 100 W
Volts: 100-277 V ~

Terminado: Negro
IRC: 80
Vida útil: **25 000 h**
Ángulo: 110 °
IP: 65
Tipo de lámpara: LED (Integrado)
Atenuable: No

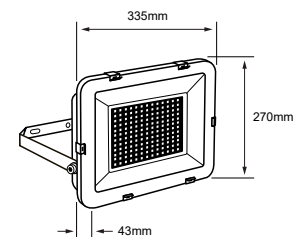

NUEVO
IZAR III
150LQLEDL65MVN
LUZ DE DÍA
● 6 500 K

Lumens: **13 500 lm**
Potencia: 150 W
Volts: 100-277 V ~

Terminado: Negro
IRC: 80
Vida útil: **25 000 h**
Ángulo: 110 °
IP: 65
Tipo de lámpara: LED (Integrado)
Atenuable: No

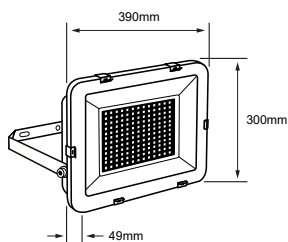

NUEVO
IZAR IV
200LQLEDL65MVN
LUZ DE DÍA
● 6 500 K

Lumens: **18 000 lm**
Potencia: 200 W
Volts: 100-277 V ~

Terminado: Negro
IRC: 80
Vida útil: **25 000 h**
Ángulo: 110 °
IP: 65
Tipo de lámpara: LED (Integrado)
Atenuable: No

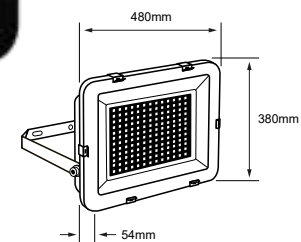

NUEVO
IZAR V
300LQLEDL65MVN
LUZ DE DÍA
● 6 500 K

Lumens: **27 000 lm**
Potencia: 300 W
Volts: 100-277 V ~

Terminado: Negro
IRC: 80
Vida útil: **25 000 h**
Ángulo: 110 °
IP: 65
Tipo de lámpara: LED (Integrado)
Atenuable: No

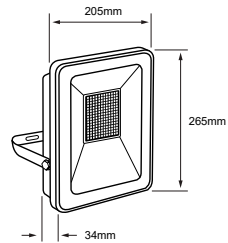
**NUEVO**
ZIBAL V
 100LQLEDT65MVN

 LUZ DE DÍA
 ● 6 500 K

 Lumens: **8 000 lm**
 Potencia: 100 W
 Volts: 100-277 V ~

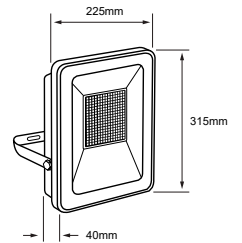
 Terminado: **Negro**
 IRC: 80
 Vida útil: **25 000 h**
 Ángulo: 120 °
 IP: 65
 Tipo de lámpara: LED (Integrado)
 Atenuable: No
**NUEVO**
ZIBAL VI
 150LQLEDT65MVN

 LUZ DE DÍA
 ● 6 500 K

 Lumens: **12 000 lm**
 Potencia: 150 W
 Volts: 100-277 V ~

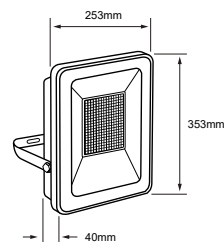
 Terminado: **Negro**
 IRC: 80
 Vida útil: **25 000 h**
 Ángulo: 120 °
 IP: 65
 Tipo de lámpara: LED (Integrado)
 Atenuable: No
**NUEVO**
ZIBAL VII
 200LQLEDT65MVN

 LUZ DE DÍA
 ● 6 500 K

 Lumens: **16 000 lm**
 Potencia: 200 W
 Volts: 100-277 V ~

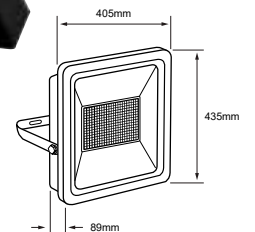
 Terminado: **Negro**
 IRC: 80
 Vida útil: **25 000 h**
 Ángulo: 120 °
 IP: 65
 Tipo de lámpara: LED (Integrado)
 Atenuable: No
**NUEVO**
ZIBAL VIII
 300LQLEDT65MVN

 LUZ DE DÍA
 ● 6 500 K

 Lumens: **27 000 lm**
 Potencia: 300 W
 Volts: 100-277 V ~

 Terminado: **Negro**
 IRC: 80
 Vida útil: **25 000 h**
 Ángulo: 120 °
 IP: 65
 Tipo de lámpara: LED (Integrado)
 Atenuable: No

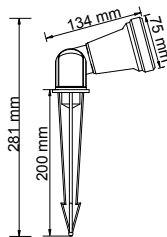

BILBAO
H-750/V

Potencia: 50 W
Volts: 100-240 V ~ / 12 V ~

Terminado: Verde
IP: 45
Tipo de base: GX5.3
Tipo de lámpara: EXN (No incluida)
Incluye estaca

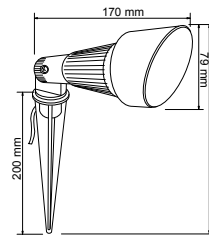

BILBAO I
H-750-V/N

Potencia: 50 W
Volts: 100-240 V ~ / 12 V ~

Terminado: Negro
IP: 45
Tipo de base: GX5.3
Tipo de lámpara: EXN (No incluida)
Incluye estaca

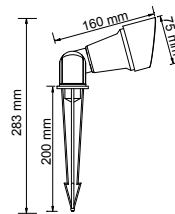

BILBAO III
HFV-750-V/N

Potencia máx.: 20 W
Volts: 100-240 V ~

Terminado: Negro
IP: 45
Tipo de base: GX5.3
Tipo de lámpara: MR16 (No incluida)
Incluye estaca

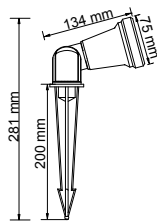

BILBAO IV
HFV-750/N

Potencia máx.: 20 W
Volts: 100-240 V ~

Terminado: Negro
IP: 45
Tipo de base: GX5.3
Tipo de lámpara: MR16 (No incluida)
Incluye estaca

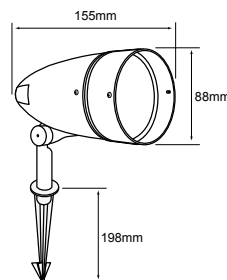

BACO
H-780/CF

Potencia máx.: 50 W
Volts: 100-240 V ~

Terminado: Café
IP: 45
Tipo de base: E27
Tipo de lámpara: PAR20 (No incluida)
Incluye estaca

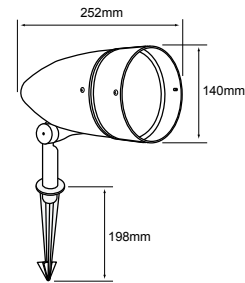

BACO I
H-790/CF

Potencia máx.: 90 W
Volts: 100-240 V ~

Terminado: Café
IP: 45
Tipo de base: E27
Tipo de lámpara: PAR38 (No incluida)
Incluye estaca

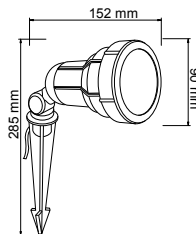

BILAR
H-715/N

Potencia máx.: 50 W
Volts: 100-240 V ~

Terminado: Negro
IP: 65
Tipo de base: E27

Tipo de lámpara: PAR20 (No incluida)
Incluye estaca

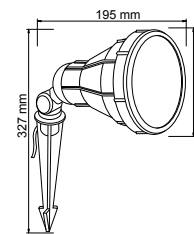

BILAR I
H-725/N

Potencia máx.: 90 W
Volts: 100-240 V ~

Terminado: Negro
IP: 65
Tipo de base: E27

Tipo de lámpara: PAR38 (No incluida)
Incluye estaca

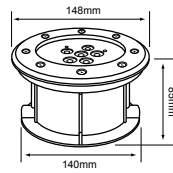

CHICAGO
HLED-530/7.5W/30

LUZ SUAVE CÁLIDA
● 3 000 K

Lumens: **350 lm**
Potencia: 7.5 W
Volts: 100-240 V ~

Terminado: **Satinado**
IRC: **80**
Vida útil: **30 000 h**
Ángulo: 40 °
IP: **68**
Tipo de lámpara: **LED (Integrado)**
Corte de empotramiento: **140 mm**
Atenuable: **No**
No utilice fuera del agua

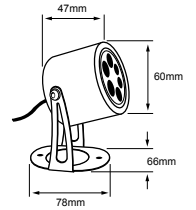

ANTARES I
6HLED511DC30S

LUZ SUAVE CÁLIDA
● 3 000 K

Lumens: **450 lm**
Potencia: 6.5 W
Volts: 12 VCD

Terminado: **Satin**
IRC: **80**
Vida útil: **20 000 h**
Ángulo: 15 °
IP: **68**
Tipo de lámpara: **LED (Integrado)**
Atenuable: **No**
Para uso exclusivo dentro del agua
Requiere Driver 12 VDC

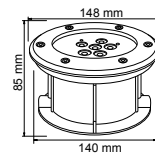

CHICAGO I
HLED-530/7.5WRGB

RGB
● RGB

Potencia: 7.5 W
Volts: 100-240 V ~

Terminado: **Satinado**
Vida útil: **30 000 h**
Ángulo: 40 °
IP: **68**
Tipo de lámpara: **LED (Integrado)**
Corte de empotramiento: **140 mm**
Atenuable: **No**
No utilice fuera del agua
Incluye driver con secuencia de color

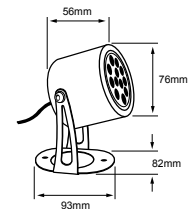

ANTARES II
10HLED512DC30S

LUZ SUAVE CÁLIDA
● 3 000 K

Lumens: **740 lm**
Potencia: 10 W
Volts: 12 VCD

Terminado: **Satin**
IRC: **80**
Vida útil: **20 000 h**
Ángulo: 21 °
IP: **68**
Tipo de lámpara: **LED (Integrado)**
Atenuable: **No**
Para uso exclusivo dentro del agua
Requiere Driver 12 VDC





N



V

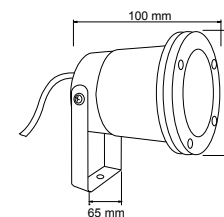

DENIA
H-505/N Negro

LUZ SUAVE CÁLIDA
● 3 000 K

Lumens: **330 lm**
Potencia: 50 W
Volts: 100-127 V ~ / 12 V ~

IRC: 80
Vida útil: **2 000 h**
Ángulo: 38 °
IP: 67

H-500/V Verde

Tipo de base: GX5.3
Tipo de lámpara: EXN 50 W (Incluida)
Atenuable: No
Sumergible baja profundidad
Requiere transformador 12 V

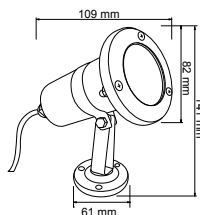

ESCALONA
H-510/S

LUZ SUAVE CÁLIDA
● 3 000 K

Lumens: **330 lm**
Potencia: 50 W
Volts: 100-127 V ~ / 12 V ~

Terminado: **Satinado**
IRC: 80
Vida útil: **2 000 h**
Ángulo: 38 °
IP: 68
Tipo de base: GX5.3
Tipo de lámpara: EXN 50 W (Incluida)
Atenuable: No
Sumergible baja profundidad
Requiere transformador 12 V

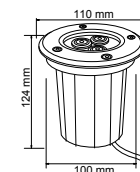

DIJON
H-520/3W/30

LUZ SUAVE CÁLIDA
● 3 000 K

Lumens: **150 lm**
Potencia: 3 W
Volts: 12 V

Terminado: **Satinado**
IRC: 80
Vida útil: **20 000 h**
Ángulo: 20 °
IP: 68
Tipo de lámpara: LED (Integrado)
Corte de empotramiento: 100 mm
Atenuable: No
Sumersión máxima 1 m
Requiere Driver 12 V

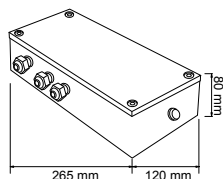

CONTROLADOR PARA LUMINARIO
H-520/36W/CONTROL

Potencia: 36 W
Volts: 100-127 V ~

Terminado: **Gris**
Uso exclusivo con H-520/3W/RGB



DIJON
H-520/3W/RGB

RGB
● RGB
Potencia: 3 W
Volts: 12 V

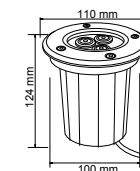

Terminado: **Satinado**
Vida útil: **20 000 h**
Ángulo: 20 °
IP: 68
Tipo de lámpara: LED (Integrado)
Corte de empotramiento: 100 mm
Atenuable: No
Sumersión máxima 1 m
Requiere controlador H-523/36W/
Control para secuencia de colores.

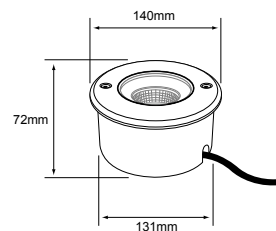

MOMO HLED-653/30

LUZ SUAVE CÁLIDA
● 3 000 K

Lumens: **950 lm**
Potencia: **14 W**
Volts: **127 V ~**

Terminado: **Satin**
IRC: **80**
Vida útil: **20 000 h**
Ángulo: **42 °**
IP: **67**
Tipo de lámpara: **LED (Integrado)**
Corte de empotramiento: **132 mm**
Atenuable: **No**

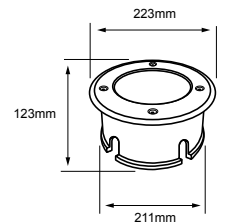

MONOCEROS 30HLED962V30S

LUZ SUAVE CÁLIDA
● 3 000 K

Lumens: **2 750 lm**
Potencia: **30 W**
Volts: **127 V ~**

Terminado: **Satinado**
IRC: **80**
Vida útil: **20 000 h**
Ángulo: **97 °**
IP: **67**
Tipo de lámpara: **LED (integrado)**
Corte de empotramiento: **205 mm**
Atenuable: **No**

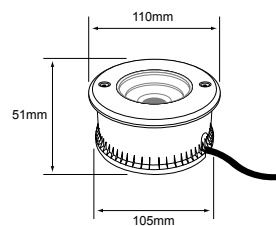

ORBIX HLED-651/30

LUZ SUAVE CÁLIDA
● 3 000 K

Lumens: **800 lm**
Potencia: **10 W**
Volts: **100-127 V ~**

Terminado: **Satinado**
IRC: **80**
Vida útil: **20 000 h**
Ángulo: **79 °**
IP: **67**
Tipo de lámpara: **LED (Integrado)**
Corte de empotramiento: **105 mm**
Atenuable: **No**

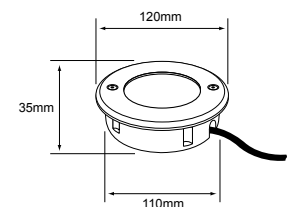

RUTA HLED-961/30

LUZ SUAVE CÁLIDA
● 3 000 K

Lumens: **280 lm**
Potencia: **9 W**
Volts: **127 V ~**

Terminado: **Satin**
IRC: **80**
Vida útil: **20 000 h**
Ángulo: **90 °**
IP: **67**
Tipo de lámpara: **LED (Integrado)**
Corte de empotramiento: **115 mm**
Atenuable: **No**



CUENCA IV
12HLED615MV30N

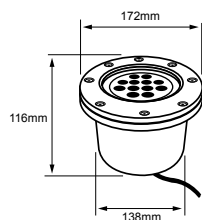

LUZ SUAVE CÁLIDA
● 3 000 K

Lumens: 900 lm
Potencia: 12 W
Volts: 100-240 V ~

Terminado: **Negro**
IRC: **80**
Vida útil: **15 000 h**
Ángulo: **23 °**
IP: **65**
Tipo de lámpara: **LED (Integrado)**
Corte de empotramiento: **142 mm**
Atenuable: **No**



CUENCA V
18HLED625MV30N

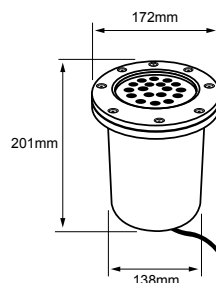

LUZ SUAVE CÁLIDA
● 3 000 K

Lumens: 1 300 lm
Potencia: 18 W
Volts: 100-240 V ~

Terminado: **Negro**
IRC: **80**
Vida útil: **15 000 h**
Ángulo: **22 °**
IP: **65**
Tipo de lámpara: **LED (Integrado)**
Corte de empotramiento: **142 mm**
Atenuable: **No**



CEDRELA
HLED-909/30

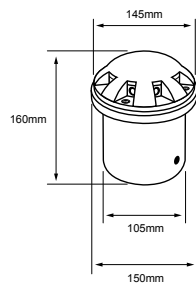

LUZ SUAVE CÁLIDA
● 3 000 K

Lumens: 400 lm
Potencia: 8 W
Volts: 100-127 V ~

Terminado: **Gris**
IRC: **80**
Vida útil: **20 000 h**
Ángulo: **12 °**
IP: **67**
Tipo de lámpara: **LED (Integrado)**
Corte de empotramiento: **115 mm**
Atenuable: **No**



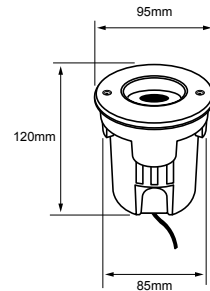

CANOPUS 7HLED654DC30S

LUZ SUAVE CÁLIDA
● 3 000 K

Lumens: **325 lm**
Potencia: **7 W**
Volts: **24 VCD**

Terminado: **Satinado**
IRC: **80**
Vida útil: **20 000 h**
Ángulo: **130 °**
IP: **67**
Tipo de lámpara: **LED (Integrado)**
Corte de empotramiento: **85 mm**
Atenuable: **No**
Requiere Driver **24 VDC (No incluido)**
Drivers recomendados: **AC7505G / AC7515B / AC7525B**
marca **Construlita**



CALGARY HLED-3W/S

LUZ SUAVE CÁLIDA
● 3 000 K

Lumens: **6 lm**
Potencia: **3 W**
Volts: **100-240 V ~**

Terminado: **Satinado**
IRC: **80**
Vida útil: **25 000 h**
Ángulo: **45 °**
IP: **45**
Tipo de lámpara: **LED (Integrado)**
Corte de empotramiento: **76 mm**
Atenuable: **No**

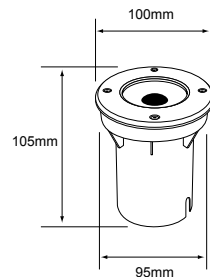
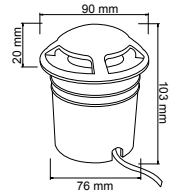

CALICUT HLED-650/12W/30

LUZ SUAVE CÁLIDA
● 3 000 K

Lumens: **800 lm**
Potencia: **12 W**
Volts: **100-240 V ~**

Terminado: **Aluminio**
IRC: **80**
Vida útil: **25 000 h**
Ángulo: **30 °**
IP: **65**
Tipo de lámpara: **LED (Integrado)**
Corte de empotramiento: **95 mm**
Atenuable: **No**

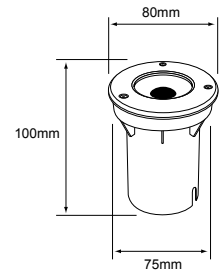

CALICUT I HLED-650/6W/30

LUZ SUAVE CÁLIDA
● 3 000 K

Lumens: **400 lm**
Potencia: **6 W**
Volts: **100-240 V ~**

Terminado: **Aluminio**
IRC: **80**
Vida útil: **25 000 h**
Ángulo: **30 °**
IP: **65**
Tipo de lámpara: **LED (Integrado)**
Corte de empotramiento: **75 mm**
Atenuable: **No**

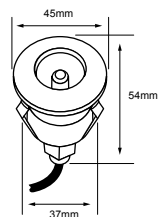

BARATI
HLED-645/2W/S
LUZ SUAVE CÁLIDA
● 3 000 K

Lumens: **60 lm**
Potencia: 2 W
Volts: 100-240 V ~

Terminado: **Satinado**
IRC: **80**
Vida útil: **20 000 h**
Ángulo: **20 °**
IP: **65**
Tipo de lámpara: **LED (Integrado)**
Corte de empotramiento: **38 mm**
Atenuable: **No**

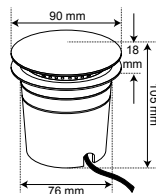

CERES
HLED-940/1W/30/S

LUZ SUAVE CÁLIDA
● 3 000 K

Lumens: **50 lm**
Potencia: 1 W
Volts: 100-240 V ~

Terminado: **Gris**
IRC: **80**
Vida útil: **15 000 h**
Ángulo: **360 °**
IP: **65**
Tipo de lámpara: **LED (Integrado)**
Corte de empotramiento: **76 mm**
Atenuable: **No**

Lámparas a 12 V requiere transformador.

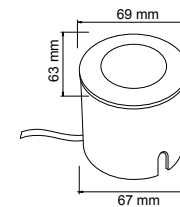

ANYAMA
HLED-960/S

LUZ BLANCA NEUTRA
○ 4 000 K

Lumens: **10 lm**
Potencia: 1.2 W
Volts: 100-127 V ~

Terminado: **Satinado**
IRC: **80**
Vida útil: **20 000 h**
Ángulo: **120 °**
IP: **65**
Tipo de lámpara: **LED (Integrado)**
Corte de empotramiento: **67 mm**
Atenuable: **No**

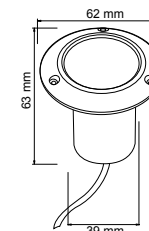

ADANA
HLED-640/5W/S

LUZ SUAVE CÁLIDA
● 3 000 K

Lumens: **150 lm**
Potencia: 5 W
Volts: 100-240 V ~

Terminado: **Satinado**
IRC: **80**
Vida útil: **25 000 h**
Ángulo: **45 °**
IP: **65**
Tipo de lámpara: **LED (Integrado)**
Corte de empotramiento: **39 mm**
Atenuable: **No**

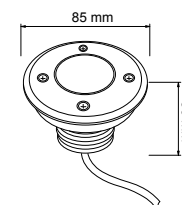

AUCKLAND
HLED-646/3W/S

LUZ SUAVE CÁLIDA
● 3 000 K

Lumens: **60 lm**
Potencia: 3 W
Volts: 100-240 V ~

Terminado: **Satinado**
IRC: **80**
Vida útil: **20 000 h**
Ángulo: **45 °**
IP: **65**
Tipo de lámpara: **LED (Integrado)**
Corte de empotramiento: **80 mm**
Atenuable: **No**
Incluye Housing

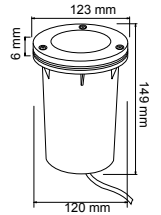

DAROCA I

H-651/S

Potencia: 50 W
Volts: 100-240 V ~ / 12 V ~

Terminado: **Satinado**
IP: 65
Tipo de base: GX5.3 / GU10
Tipo de lámpara: MR16 / GU10 (No incluida)
Corte de empotramiento: 120 mm
Atenuable: **No**

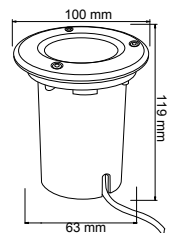

COIMBRA

H-600/S

Potencia: 50 W
Volts: 100-240 V ~ / 12 V ~

Terminado: **Satinado**
IP: 65
Tipo de base: GX5.3 / GU10
Tipo de lámpara: MR16 / GU10 (No incluida)
Corte de empotramiento: 64 mm
Atenuable: **No**



CONSTANZA
H-605/N

Potencia máx.: 50 W
Volts: 100-240 V ~

Terminado: Negro
IP: 65
Tipo de base: E27
Tipo de lámpara: PAR20 (No incluida)
Corte de empotramiento: 90 mm
Se sugiere lámpara PAR LED, disponible

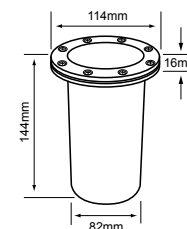
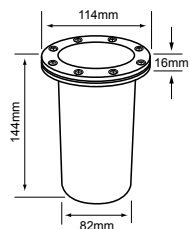

CONSTANZA I
H-605/S

Potencia máx.: 50 W
Volts: 100-240 V ~

Terminado: Satinado
IP: 65
Tipo de base: E27
Tipo de lámpara: PAR20 (No incluida)
Corte de empotramiento: 90 mm
Se sugiere lámpara PAR LED, disponible



CUENCA
H-615/N

Potencia máx.: 50 W
Volts: 100-240 V ~ / 12 V ~

Terminado: Negro
IP: 65
Tipo de base: G53
Tipo de lámpara: AR111 (No incluida)
Corte de empotramiento: 172 mm

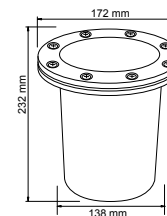
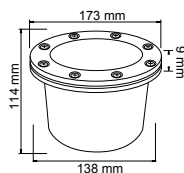

CUENCA III
H-625/S

Potencia máx.: 90 W
Volts: 100-240 V ~

Terminado: Satinado
IP: 65
Tipo de base: E27
Tipo de lámpara: PAR38 (No incluida)
Corte de empotramiento: 138 mm
Se sugiere lámpara LED menor a 15 W, disponible



CUENCA I
H-625/N

Potencia máx.: 90 W
Volts: 100-240 V ~

Terminado: Negro
IP: 65
Tipo de base: E27
Tipo de lámpara: PAR38 (No incluida)
Corte de empotramiento: 138 mm
Se sugiere lámpara LED menor a 15 W, disponible

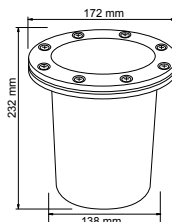

Lámparas a 12 V requiere transformador.



G

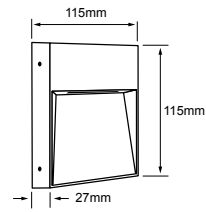

N

**NUEVO****KAVE I**

8HLED807CV30G Gris
Lumens: **340 lm**

LUZ SUAVE CÁLIDA
● 3 000 K

Potencia: 8 W
Volts: 127 V ~

8HLED807CV30N Negro
Lumens: **270 lm**

Instalación: **Sobreponer**
IRC: 80
Vida útil: **15 000 h**
Ángulo: 45 °
IP: 54
Tipo de lámpara: LED (Integrado)
Atenuable: No



G

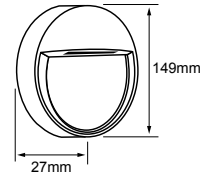

N

**NUEVO****HUNOR I**

8HLED807RV30G Gris
Lumens: **350 lm**

LUZ SUAVE CÁLIDA
● 3 000 K

Potencia: 8 W
Volts: 127 V ~

8HLED807RV30N Negro
Lumens: **250 lm**

Instalación: **Sobreponer**
IRC: 80
Vida útil: **15 000 h**
Ángulo: 45 °
IP: 54
Tipo de lámpara: LED (Integrado)
Atenuable: No



G

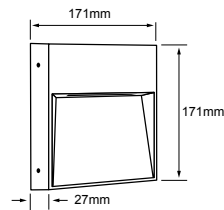

N

**NUEVO****KAVE II**

16HLED808CV30G Gris
Lumens: **710 lm**

LUZ SUAVE CÁLIDA
● 3 000 K

Potencia: 16 W
Volts: 127 V ~

16HLED808CV30N Negro
Lumens: **550 lm**

Instalación: **Sobreponer**
IRC: 80
Vida útil: **15 000 h**
Ángulo: 51 °
IP: 54
Tipo de lámpara: LED (Integrado)
Atenuable: No



G

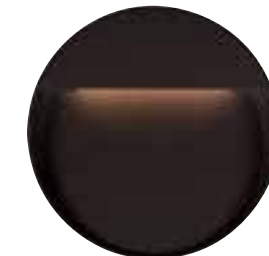

N

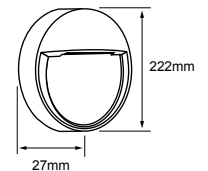
**NUEVO****HUNOR II**

16HLED808RV30G Gris
Lumens: **700 lm**

LUZ SUAVE CÁLIDA
● 3 000 K

Potencia: 16 W
Volts: 127 V ~

16HLED808RV30N Negro
Lumens: **550 lm**

Instalación: **Sobreponer**
IRC: 80
Vida útil: **15 000 h**
Ángulo: 48 °
IP: 54
Tipo de lámpara: LED (Integrado)
Atenuable: No



G

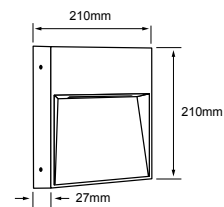

N

**NUEVO****KAVE III**

24HLED809CV30G Gris
Lumens: **800 lm**

LUZ SUAVE CÁLIDA
● 3 000 K

Potencia: 24 W
Volts: 127 V ~

24HLED809CV30N Negro
Lumens: **1 050 lm**

Instalación: **Sobreponer**
IRC: 80
Vida útil: **15 000 h**
Ángulo: 52 °
IP: 54
Tipo de lámpara: LED (Integrado)
Atenuable: No



G

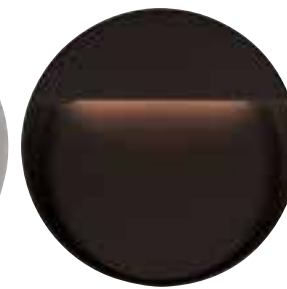

N

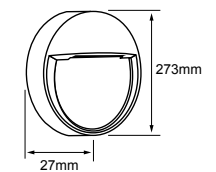
**NUEVO****HUNOR III**

24HLED809RV30G Gris
Lumens: **960 lm**

LUZ SUAVE CÁLIDA
● 3 000 K

Potencia: 24 W
Volts: 127 V ~

24HLED809RV30N Negro
Lumens: **720 lm**

Instalación: **Sobreponer**
IRC: 80
Vida útil: **15 000 h**
Ángulo: 47 °
IP: 54
Tipo de lámpara: LED (Integrado)
Atenuable: No



G



N

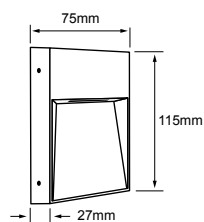

NUEVO

KAVE IV

5HLED812CV30G Gris
Lumens: **200 lm**

LUZ SUAVE CÁLIDA
● 3 000 K

Potencia: 5 W
Volts: 127 V ~

Instalación: **Sobreponer**

IRC: **80**
Vida útil: **15 000 h**
Ángulo: 45°
IP: 54

Tipo de lámpara: **LED (Integrado)**
Atenuable: **No**



N



G

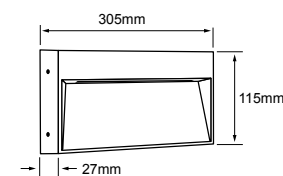

NUEVO

KAVE V

24HLED813CV30G Gris
Lumens: **1 030 lm**

LUZ SUAVE CÁLIDA
● 3 000 K

Potencia: 24 W
Volts: 127 V ~

Instalación: **Sobreponer**

IRC: **80**
Vida útil: **15 000 h**
Ángulo: 51°
IP: 54

Tipo de lámpara: **LED (Integrado)**
Atenuable: **No**

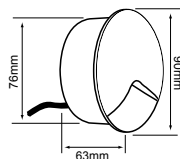
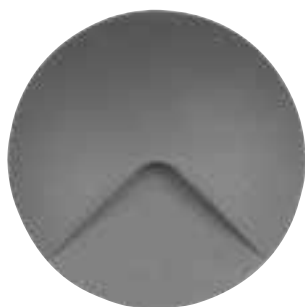

CETI

HLED-916/30/G

LUZ SUAVE CÁLIDA
● 3 000 K

Lumens: **35 lm**
Potencia: 2.5 W
Volts: 100-127 V ~

Instalación: **Empotrado**

Terminado: **Gris**
IRC: **80**
Vida útil: **20 000 h**
Ángulo: 29°
IP: 54

Tipo de lámpara: **LED (Integrado)**
Corte de empotramiento: **76 mm**
Atenuable: **No**

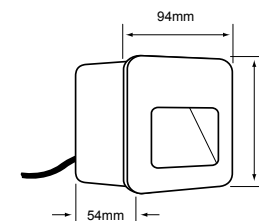

BHARANI

HLED-907/30/G

LUZ SUAVE CÁLIDA
● 3 000 K

Lumens: **50 lm**
Potencia: 2 W
Volts: 100-127 V ~

Instalación: **Empotrado**

Terminado: **Gris**
IRC: **80**
Vida útil: **20 000 h**
Ángulo: 29°
IP: 54

Tipo de lámpara: **LED (Integrado)**
Corte de empotramiento: **92 mm x 88 mm x 60 mm**
Atenuable: **No**



B



N

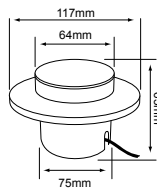

ESFERIS
HLED-941/30/B
Blanco

LUZ SUAVE CÁLIDA
● 3 000 K

Lumens: **120 lm**
Potencia: **6 W**
Volts: **100-240 V ~**

Instalación: **Empotrado**
IRC: **80**
Vida útil: **15 000 h**
Ángulo: **152 °**
IP: **65**
Tipo de lámpara: **LED (Integrado)**
Corte de empotramiento: **75 mm**
Atenuable: **No**



B



N

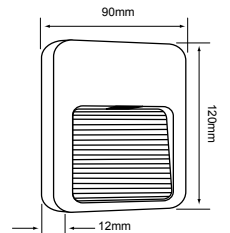

AVIOR
HLED-903/B
Blanco

LUZ SUAVE CÁLIDA
● 3 000 K

Lumens: **60 lm**
Potencia: **1.5 W**
Volts: **100-240 V ~**

Instalación: **Sobreponer**
IRC: **80**
Vida útil: **15 000 h**
Ángulo: **50 °**
IP: **65**
Tipo de lámpara: **LED (Integrado)**
Incluye: **Driver LED**
Atenuable: **No**



NUEVO
SUPERBA I
3HLED1165MV30N

LUZ SUAVE CÁLIDA
● 3 000 K

Lumens: **13 lm**
Potencia: **3 W**
Volts: **100-240 V ~**

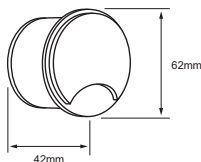

Instalación: **Empotrado**
Terminado: **Negro Opaco**
IRC: **80**
Vida útil: **30 000 h**
Ángulo: **80 °**
IP: **65**
Tipo de lámpara: **LED (integrado)**
Corte de empotramiento: **55 mm**
Atenuable: **No**



NUEVO
SUPERBA II
3HLED1166MV30N

LUZ SUAVE CÁLIDA
● 3 000 K

Lumens: **18 lm**
Potencia: **3 W**
Volts: **100-240 V ~**

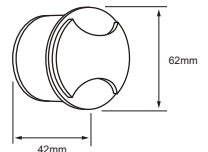

Instalación: **Empotrado**
Terminado: **Negro Opaco**
IRC: **80**
Vida útil: **30 000 h**
Ángulo: **80 °**
IP: **65**
Tipo de lámpara: **LED (integrado)**
Corte de empotramiento: **55 mm**
Atenuable: **No**



ANSHAN III
3HLED802VB
Blanco

LUZ BLANCA NEUTRA
○ 4 000 K

Lumens: **200 lm**
Potencia: 2.5 W
Volts: 100-127 V ~



B



G

3HLED802VG
Gris

Instalación: **Sobreponer**
Terminado: **Gris**
IRC: 80
Vida útil: **15 000 h**
IP: 65
Tipo de lámpara: **LED (Integrado)**
Atenuable: **No**

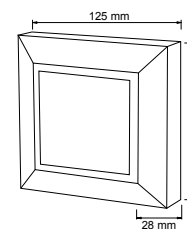

ANSHAN I
HLED-803/B
Blanco

LUZ BLANCA NEUTRA
○ 4 000 K

Lumens: **100 lm**
Potencia: 1 W
Volts: 100-127 V ~



B



G

HLED-803/G
Gris

Instalación: **Sobreponer**
IRC: 80
Vida útil: **15 000 h**
IP: 65
Tipo de lámpara: **LED (Integrado)**
Atenuable: **No**

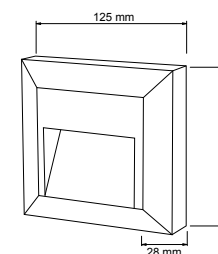

ANSHAN II
HLED-804/B
Blanco

LUZ BLANCA NEUTRA
○ 4 000 K

Lumens: **100 lm**
Potencia: 1 W
Volts: 100-127 V ~



B



G

HLED-804/G
Gris

Instalación: **Sobreponer**
IRC: 80
Vida útil: **15 000 h**
IP: 65
Tipo de lámpara: **LED (Integrado)**
Atenuable: **No**

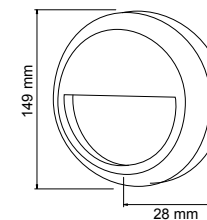

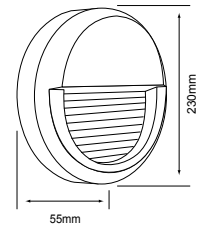
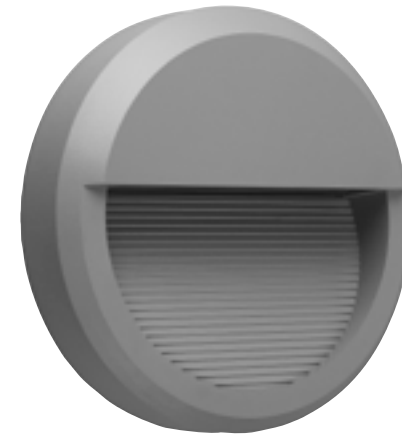
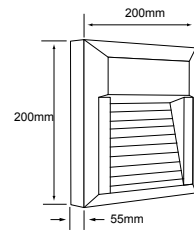
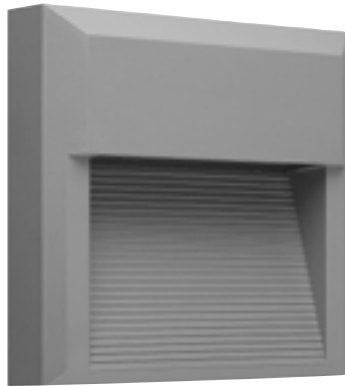

ANSHAN V HLED-806/S

LUZ SUAVE CÁLIDA
● 3 000 K

Lumens: 250 lm
Potencia: 9.5 W
Volts: 100-240 V ~

Instalación: **Sobreponer**
Terminado: **Satin**
IRC: **80**
Vida útil: **20 000 h**
Ángulo: **47 °**
IP: **65**
Tipo de lámpara: **LED (Integrado)**
Atenuable: **No**

ANSHAN IV HLED-805/S

LUZ SUAVE CÁLIDA
● 3 000 K

Lumens: 250 lm
Potencia: 9.5 W
Volts: 100-240 V ~

Instalación: **Sobreponer**
Terminado: **Satin**
IRC: **80**
Vida útil: **20 000 h**
Ángulo: **47 °**
IP: **65**
Tipo de lámpara: **LED (Integrado)**
Atenuable: **No**

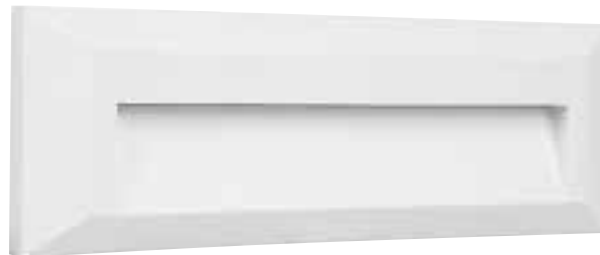

B

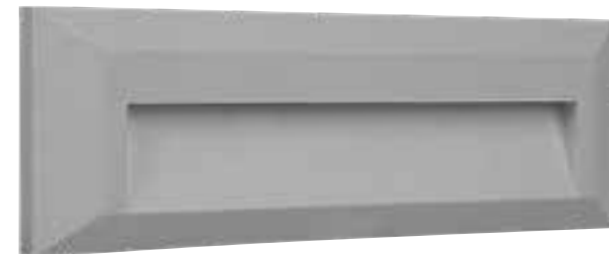

G

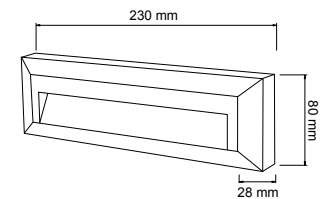

ANSHAN HLED-801/B Blanco

LUZ BLANCA NEUTRA
○ 4 000 K

Lumens: 120 lm
Potencia: 1.5 W
Volts: 100-127 V ~

HLED-801/G Gris

Instalación: **Sobreponer**
IRC: **80**
Vida útil: **15 000 h**
IP: **65**
Tipo de lámpara: **LED (Integrado)**
Atenuable: **No**

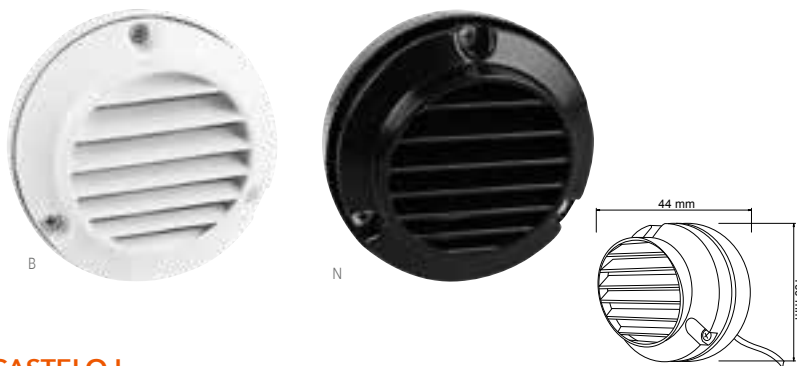

CASTELO I
2HLED925DC30B - Blanco

2HLED925DC30N - Negro

LUZ SUAVE CÁLIDA
● 3 000 K

Lumens: **33 lm**
Potencia: **2 W**
Volts: **12 VCD**

Instalación: **Sobreponer**
IRC: **80**
Vida útil: **15 000 h**
Ángulo: **65 °**
IP: **45**
Tipo de base: **G4**
Tipo de lámpara: **LED 2W (Incluido)**
Corte de empotramiento: **44 mm x 100 mm**
Atenuable: **No**
Requiere Driver **12 V**

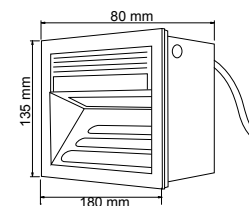

TULA I
HLED-904/S

LUZ SUAVE CÁLIDA
● 3 000 K

Lumens: **20 lm**
Potencia: **3 W**
Volts: **100-127 V ~**

Instalación: **Empotrado**
Terminado: **Satinado**
IRC: **80**
Vida útil: **15 000 h**
Ángulo: **120 °**
IP: **44**
Tipo de lámpara: **LED (Integrado)**
Corte de empotramiento: **125 mm x 170 mm**
Atenuable: **No**

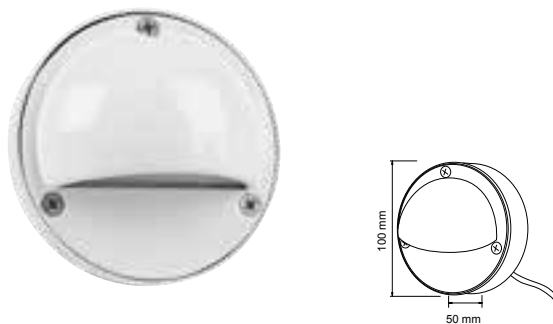

CASPE I
2HLED920DC30B

LUZ SUAVE CÁLIDA
● 3 000 K

Lumens: **33 lm**
Potencia: **2 W**
Volts: **12 VDC**

Instalación: **Sobreponer**
Terminado: **Blanco**
IRC: **80**
Vida útil: **15 000 h**
Ángulo: **70 °**
IP: **45**
Tipo de lámpara: **LED 2W (incluido)**
Tipo de base: **G4**
Atenuable: **No**
Requiere Driver **12 V**

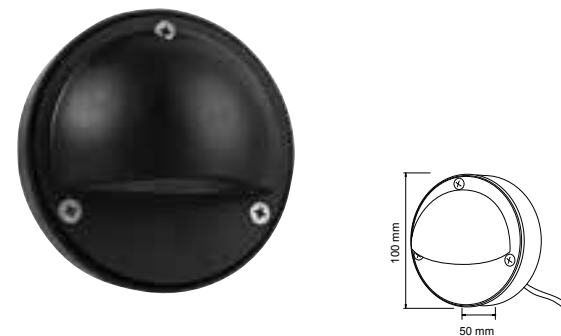

CASPE I
HLED-920/N

LUZ SUAVE CÁLIDA
● 3 000 K

Lumens: **50 lm**
Potencia: **1 W**
Volts: **100-240 V**

Instalación: **Sobreponer**
Terminado: **Negro**
IRC: **80**
Vida útil: **15 000 h**
Ángulo: **44 °**
IP: **45**
Tipo de lámpara: **LED (Integrado)**
Tipo de base: **G4**
Atenuable: **No**

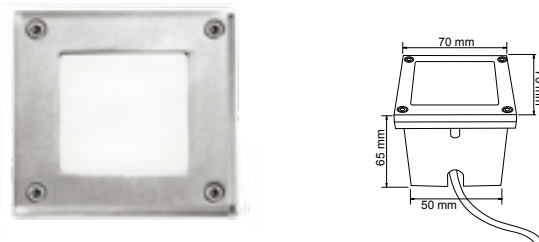

CERDEÑA I
HLED-905/S

LUZ SUAVE CÁLIDA
● 3 000 K

Lumens: **4 lm**
Potencia: **0.6 W**
Volts: **100-127 V ~**

Instalación: **Empotrado**
Terminado: **Satinado**
IRC: **80**
Vida útil: **15 000 h**
Ángulo: **120 °**
IP: **65**
Tipo de lámpara: **LED (Integrado)**
Corte de empotramiento: **50 mm x 50 mm**
Atenuable: **No**



CERDEÑA I
HLED-910/S

LUZ SUAVE CÁLIDA
● 3 000 K

Lumens: **4 lm**
Potencia: **0.6 W**
Volts: **100-127 V ~**

Instalación: **Empotrado**
Terminado: **Satinado**
IRC: **80**
Vida útil: **15 000 h**
Ángulo: **120 °**
IP: **45**
Tipo de lámpara: **LED (Integrado)**
Corte de empotramiento: **74 mm x 50 mm**
Atenuable: **No**

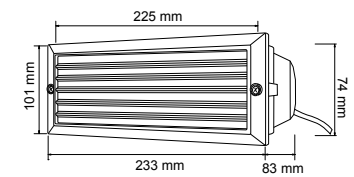
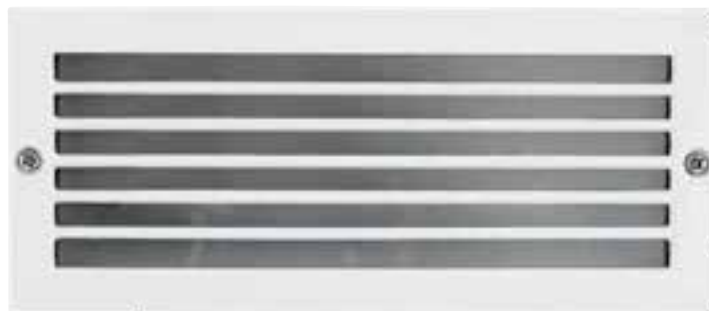

CASTILLO

H-930/B

LUZ SUAVE CÁLIDA
● 2 700 K

Potencia: 13 W
Volts: 100-127 V ~

Instalación: **Empotrado**
Terminado: **Blanco**
IP: **45**
Tipo de base: **E27**
Tipo de lámpara: **Fluorescente 13 W (Incluída)**
Corte de empotramiento: **225 mm x 74 mm**
Atenuable: **No**

Lámparas a 12 V requiere transformador.



EXTERIOR

SUBURBANA INDUSTRIAL

VIVE LA INNOVACIÓN CON
LA SEGURIDAD DE LA ILUMINACIÓN

tecnolite®
LA LUZ ES TUYA



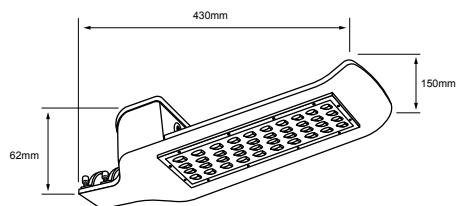

INDUS II

60ESLED730MV65S

LUZ DE DÍA
● 6 500 K

Lumens: **6 000 lm**
Potencia: 60 W
Volts: 100-240 V ~

Terminado: **Satinado**
IRC: 70
Vida útil: **50 000 h**
Ángulo: 120 °
IP: 65
Tipo de lámpara: LED (integrado)
Fotocelda. Diámetro del tubo requerido 50 mm

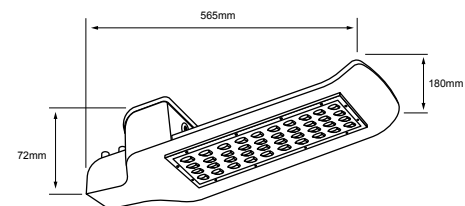

INDUS III

120ESLED730MV65S

LUZ DE DÍA
● 6 500 K

Lumens: **12 000 lm**
Potencia: 120 W
Volts: 100-240 V ~

Terminado: **Satinado**
IRC: 70
Vida útil: **50 000 h**
Ángulo: 120 °
IP: 65
Tipo de lámpara: LED (integrado)
Fotocelda. Diámetro del tubo requerido 60 mm

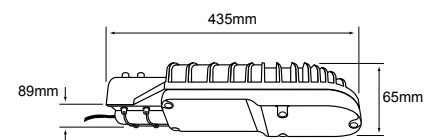

KAPPA

ES-LED/040/65

LUZ DE DÍA
● 6 500 K

Lumens: **4 100 lm**
Potencia: 40 W
Volts: 100-240 V ~

Aplicación: **Punta de poste**
Terminado: **Satinado**
IRC: 80
Vida útil: **30 000 h**
Ángulo: 110 °

IP: 65
Tipo de lámpara: **LED (Integrado)**
Atenuable: **No**

* Productos suburbanos para aplicación Industrial / Comercial / Residencial no aptos para vialidades urbanas / vía pública

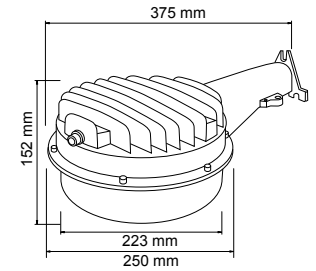

ESTOCOLMO I

ES-LED/501/G

LUZ DE DÍA
 ● 6 500 K

Lumens: **4 000 lm**
 Potencia: 50 W
 Volts: 100-127 V ~

Terminado: **Gris**
 IRC: **80**
 Vida útil: **50 000 h**
 Ángulo: **120 °**

IP: **65**
 Tipo de lámpara: **LED (Integrado)**
 Atenuable: **No**
 Incluye fotocelda

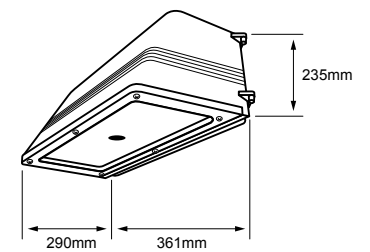

MEISSA

50WPMLEDMV40CF

LUZ DE DÍA
 ● 5 000 K

Lumens: **5 580 lm**
 Potencia: 50 W
 Volts: 100-240 V ~

Terminado: **Café**
 IRC: **70**
 Vida útil: **35 000 h**
 Ángulo: **115 °**

IP: **65**
 Tipo de lámpara: **LED (Integrado)**
 Atenuable: **No**

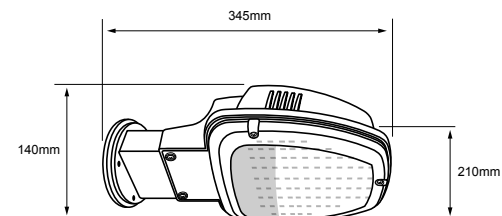

INTERCRUS

30ESLED520MV65B

LUZ DE DÍA
● 6 500 K

Lumens: **3 000 lm**
Potencia: **30 W**
Volts: **100-240 V ~**

Terminado: **Blanco**
IRC: **80**
Vida útil: **25 000 h**
Ángulo: **120 °**

IP: **65**
Tipo de lámpara: **LED (Integrado)**
Incluye: **Driver LED y fotocelda**
Atenuable: **No**



EJEMPLOS DE CONFIGURACIÓN	4 HRS 100% SIN SENSOR + 5 HRS 10% CON SENSOR 100% + 4 HRS 30% SIN SENSOR	3 HRS 70% CON SENSOR 100% + 6 HRS 50% SIN SENSOR + 4 HRS 30% CON SENSOR 50%	6 HORAS 100% SIN SENSOR + 8 HRS 50% SIN SENSOR	6 HRS 50% CON SENSOR 100% (LA LUZ SÓLO FUNCIONA LA MITAD DE LA NOCHE)	12 HRS 30% CON SENSOR 100% SÓLO DURANTE TODA LA NOCHE
B	4 H	4 H	6 H	6 H	12 H
C	100 %	100 %	100 %	100 %	100 %
D	100 %	70 %	100 %	50 %	30 %
E	5 H	6 H	6 H	0 H	0 H
F	100 %	50 %	50 %	0 %	0 %
G	50 %	50 %	50 %	0 %	0 %
H	4 H	4 H	0 H	0 H	0 H
I	30 %	50 %	0 %	0 %	0 %
J	30 %	30 %	0 %	0 %	0 %

*CONFIGURACIÓN AL 100% CON SENSOR AL 100% SOLO DURA UN MÁXIMO DE 6HRS EN CONDICIONES OPTIMAS

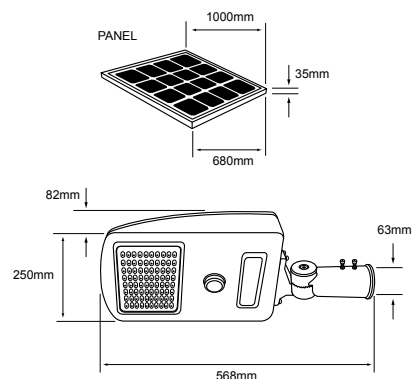

PANEL SOLAR

KOKAB

40SOLLED13VD50G

LUZ DE DÍA
● 5 000 K

Lumens: **4 800 lm**
Potencia: **40 W**
Volts: **12 VDC ~**

Aplicación: **Punta de poste**
Terminado: **Gris**
IRC: **80**
Vida útil: **50 000 h**
Ángulo: **140 °**

IP: **67**
Tipo de lámpara: **LED (Integrado)**
Atenuable: **No**
Incluye **control remoto y panel solar**

- **Programable c/control remoto**
- **Iluminación y duración ajustable**
- **Sensor de presencia**
- **Batería de litio**

* Productos suburbanos para aplicación Industrial / Comercial / Residencial no aptos para vialidades urbanas / vía pública

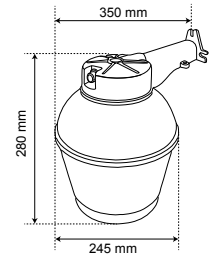

ESPEJO II

ES-6500-1

LUZ DE DIA
 ○ 6 500 K

Lumens: **4 400 lm**
 Potencia: 65 W
 Volts: 100-127 V ~

Terminado: Gris
 IRC: 80
 Vida útil: **10 000 h**
 Ángulo: 180°

IP: 43
 Tipo de base: E27
 Tipo de lámpara: Fluorescente 65 W (Incluida)
 Atenuable: No
 Incluye fotocelda



LÁMPARAS

DALE BLANCOS O PINTA CON LUZ DE COLORES
PARA PERSONALIZAR TUS MOMENTOS

tecnolite®
LA LUZ ES TUYA





EXN-SMDLED/3W/30
 LUZ SUAVE CÁLIDA
 ● 3 000 K

Lumens: 200 lm
Potencia: 3 W
Volts: 12 VDC

EXN-SMDLED/3W/65
 LUZ DE DÍA
 ○ 6 500 K

Terminado: **PC Transparente**
 IRC: **80**
 Vida útil: **20 000 h**
 Ángulo: **100°**
 Tipo de base: **GX5.3**
 Atenuable: **No**
 Dimensiones del producto: **50 mm x 47 mm**



MR11-LED/3W/30

LUZ SUAVE CÁLIDA
 ● 3 000 K

Lumens: 200 lm
Potencia: 3 W
Volts: 100-127 V ~

Terminado: **Blanco**
 IRC: **80**
 Vida útil: **15 000 h**
 Ángulo: **25°**
 Tipo de base: **G4**
 Atenuable: **No**
 Dimensiones del producto: **35 mm x 43 mm**



OCTANUS
EXNL-LED/001/30

LUZ SUAVE CÁLIDA
 ● 3 000 K

Lumens: 530 lm
Potencia: 7 W
Volts: 12 VDC

Terminado: **Blanco**
 IRC: **80**
 Vida útil: **15 000 h**
 Ángulo: **36°**
 Tipo de base: **GX5.3**
 Atenuable: **No**
 Dimensiones del producto: **50 mm x 45 mm**



ATENUABLE

RADIUM I
EXND-LED/001/30

LUZ SUAVE CÁLIDA
 ● 3 000 K

Lumens: 600 lm
Potencia: 7 W
Volts: 12 VDC

Terminado: **Blanco**
 IRC: **80**
 Vida útil: **25 000 h**
 Ángulo: **40°**
 Tipo de base: **GX5.3**
 Atenuable: **Si**
 Dimensiones del producto: **50 mm x 38.5 mm**



MR16-LED/3W/30H
LUZ SUAVE CÁLIDA
● 3 000 K

Lumens: 250 lm
Potencia: 3 W
Volts: 100-127 V ~

MR16-LED/3W/65H
LUZ DE DÍA
● 6 500 K

Terminado: **Blanco**
IRC: **80**
Vida útil: **15 000 h**
Ángulo: **36 °**
Tipo de base: **GX5.3**
Atenuable: **No**
Dimensiones del producto: **50 mm x 45 mm**



MR16-SMDLED/3W/30
LUZ SUAVE CÁLIDA
● 3 000 K

Lumens: 250 lm
Potencia: 3 W
Volts: 100-240 V ~

MR16-SMDLED/3W/65
LUZ DE DÍA
● 6 500 K

Terminado: **PC Transparente**
IRC: **80**
Vida útil: **20 000 h**
Ángulo: **80 °**
Tipo de base: **GX5.3**
Atenuable: **No**
Dimensiones del producto: **44 mm x 50 mm**



42578
LUZ SUAVE CÁLIDA
● 2 700 K

Lumens: 370 lm
Potencia: 8 W
Volts: 127 V ~

Terminado: **Blanco**
IRC: **80**
Vida útil: **25 000 h**
Ángulo: **36 °**
Tipo de base: **LED (integrado)**
Atenuable: **No**



PYXIES III
MR16L-LED/001/30
LUZ SUAVE CÁLIDA
● 3 000 K

Lumens: 550 lm
Potencia: 6 W
Volts: 100-240 V ~

MR16L-LED/001/65
LUZ DE DÍA
● 6 500 K

Terminado: **Blanco**
IRC: **80**
Vida útil: **15 000 h**
Ángulo: **36 °**
Tipo de base: **GX5.3**
Atenuable: **No**
Dimensiones del producto: **50 mm x 45 mm**



MR16-LED/5.5W/30
LUZ SUAVE CÁLIDA
● 3 000 K

Lumens: 350 lm
Potencia: 5.5 W
Volts: 100-240 V ~

MR16-LED/5.5W/65
LUZ DE DÍA
● 6 500 K

Terminado: **Blanco**
IRC: **80**
Vida útil: **15 000 h**
Ángulo: **36 °**
Tipo de base: **GX5.3**
Atenuable: **No**
Dimensiones del producto: **50 mm x 45 mm**



6MR16LLED40MV36

LUZ BLANCA NEUTRA
○ 4 000 K

Lumens: 550 lm
Potencia: 6 W
Volts: 100-240 V ~

Terminado: **Blanco**
IRC: **80**
Vida útil: **15 000 h**
Ángulo: **36 °**
Tipo de base: **GX5.3**
Tipo de lámpara: **LED integrado**
Incluye: **Driver LED**
Atenuable: **No**
Dimensiones del producto: **50 mm x 45 mm**



ATENUABLE

RADIUM II
MR16D-LED/001/30

LUZ SUAVE CÁLIDA
● 3 000 K

Lumens: 600 lm
Potencia: 7 W
Volts: 100-127 V ~



Terminado: **Blanco**
IRC: **80**
Vida útil: **25 000 h**
Ángulo: **40 °**
Tipo de base: **GX5.3**
Atenuable: **Si**
Dimensiones del producto: **50 mm x 38.5 mm**



GU10-SMDLED/3W/30
LUZ SUAVE CÁLIDA
● 3 000 K

Lumens: 250 lm
Potencia: 3 W
Volts: 100-240 V ~

Terminado: **PC Transparente**
IRC: **80**
Vida útil: **20 000 h**
Ángulo: **100°**

Tipo de base: **GU10**
Atenuable: **No**
Dimensiones del producto: **50 mm x 58 mm**

GU10-SMDLED/3W/65
LUZ DE DÍA
● 6 500 K



GU10-LED/3W/30H
LUZ SUAVE CÁLIDA
● 3 000 K

Lumens: 250 lm
Potencia: 3 W
Volts: 100-127 V ~

Terminado: **Blanco**
IRC: **80**
Vida útil: **15 000 h**
Ángulo: **36°**

GU10-LED/3W/65H
LUZ DE DÍA
● 6 500 K

Tipo de base: **GU10**
Atenuable: **No**
Dimensiones del producto: **50 mm x 54 mm**



GU10-LED/5.5W/30
LUZ SUAVE CÁLIDA
● 3 000 K

Lumens: 350 lm
Potencia: 5.5 W
Volts: 100-240 V ~

Terminado: **Blanco**
IRC: **80**
Vida útil: **15 000 h**
Ángulo: **36°**

Tipo de base: **GU10**
Atenuable: **No**
Dimensiones del producto: **50 mm x 52 mm**

GU10-LED/5.5W/65
LUZ DE DÍA
● 6 500 K



PYXIES IV
GU10L-LED/001/30
LUZ SUAVE CÁLIDA
● 3 000 K

Lumens: 550 lm
Potencia: 6 W
Volts: 100-240 V ~

Terminado: **Blanco**
IRC: **80**
Vida útil: **15 000 h**
Ángulo: **36°**

GU10L-LED/001/65
LUZ DE DÍA
● 6 500 K

Tipo de base: **GU10**
Atenuable: **No**
Dimensiones del producto: **50 mm x 54 mm**



6GU10LLED40MV36
LUZ BLANCA NEUTRA
○ 4 000 K

Lumens: 550 lm
Potencia: 6 W
Volts: 100-240 V ~

Terminado: **Blanco**
IRC: **80**
Vida útil: **15 000 h**
Ángulo: **36°**
Tipo de base: **GU10**

Tipo de Lámpara: **LED (Integrado)**
Incluye: **Driver LED**
Atenuable: **No**
Dimensiones del producto: **50 mm x 54 mm**



RADIUM III
GU10D-LED/001/30
LUZ SUAVE CÁLIDA
● 3 000 K

Lumens: 600 lm
Potencia: 7 W
Volts: 100-127 V ~

Terminado: **Blanco**
IRC: **80**
Vida útil: **25 000 h**
Ángulo: **40°**

Tipo de base: **GU10**
Atenuable: **Si**
Dimensiones del producto: **50 mm x 53.5 mm**





ATENUABLE

YED 3DG9LED65V240



LUZ DE DÍA
● 6 500 K

Lumens: **180 lm**
Potencia: **3 W**
Volts: **100 - 127 V ~**

Terminado: **Blanco**
IRC: **80**
Vida útil: **25 000 h**
Ángulo: **240 °**
Tipo de base: **G9**
Atenuable: **Si**
Dimensiones del producto: **18 mm x 49 mm**



ATENUABLE

G9D-LED/3W/30



LUZ SUAVE CÁLIDA
● 3 000 K

Lumens: **180 lm**
Potencia: **3 W**
Volts: **100-127 V ~**

Terminado: **Blanco**
IRC: **80**
Vida útil: **25 000 h**
Ángulo: **240 °**
Tipo de base: **G9**
Atenuable: **Si**
Dimensiones del producto: **18 mm x 49 mm**



ATENUABLE FLICKER FREE

6DG9LED30V360



LUZ SUAVE CÁLIDA
● 3 000 K

Lumens: **620 lm**
Potencia: **6 W**
Volts: **127 V ~**

Terminado: **Blanco**
IRC: **80**
Vida útil: **15 000 h**
Ángulo: **360 °**
Tipo de base: **G9**
Atenuable: **Si**
Dimensiones del producto: **18.5 x 157 mm**



PISCES I

2G9LED30V300C
LUZ SUAVE CÁLIDA
● 3 000 K

Lumens: **200 lm**
Potencia: **2 W**
Volts: **127 V ~**

2G9LED65V300C
LUZ DE DÍA
● 6 500 K

Terminado: **Cristal Transparente**
IRC: **80**
Vida útil: **15 000 h**
Ángulo: **300 °**
Tipo de base: **G9**
Atenuable: **No**
Dimensiones del producto: **13.2 mm x 48 mm**



ATENUABLE

PISCES II

3DG9LED30V300C
LUZ SUAVE CÁLIDA
● 3 000 K

Lumens: **350 lm**
Potencia: **3 W**
Volts: **127 V ~**



3DG9LED65V300C
LUZ DE DÍA
● 6 500 K

Terminado: **Cristal Transparente**
IRC: **80**
Vida útil: **15 000 h**
Ángulo: **360 °**
Tipo de base: **G9**
Atenuable: **Si**
Dimensiones del producto: **13.2 mm x 60 mm**



G9-LED/2.5W/30

LUZ SUAVE CÁLIDA
● 3 000 K

Lumens: **194 lm**
Potencia: **2.5 W**
Volts: **100-127 V ~**

Terminado: **Blanco**
IRC: **80**
Vida útil: **15 000 h**
Ángulo: **200 °**
Tipo de base: **G9**
Atenuable: **No**
Dimensiones del producto: **11 mm x 52 mm**



ERIDANI II

2G9LED30MV150
LUZ SUAVE CÁLIDA
● 3 000 K

Lumens: **160 lm**
Potencia: **2 W**
Volts: **100-127 V ~**

Terminado: **Blanco**
IRC: **80**
Vida útil: **15 000 h**

2G9LED65V150
LUZ DE DÍA
● 6 500 K

Ángulo: **150 °**
Tipo de base: **G9**
Atenuable: **No**
Dimensiones del producto: **19 mm x 46.5 mm**



ERIDAN I
2G4LED30DC150

LUZ SUAVE CÁLIDA
● 3 000 K

Lumens: 160 lm
Potencia: 2 W
Volts: 12 VDC

Terminado: **Blanco**
IRC: **80**
Vida útil: **15 000 h**
Ángulo: **150 °**
Tipo de base: **G4**
Atenuable: **No**
Dimensiones del producto: **19 mm x 38 mm**
Requiere Driver 12 V



JCDD-LED/3W/30

LUZ SUAVE CÁLIDA
● 3 000 K

Lumens: 180 lm
Potencia: 3 W
Volts: 100-127 V ~

Terminado: **Blanco**
IRC: **80**
Vida útil: **25 000 h**
Ángulo: **240 °**
Tipo de base: **GY6.35**
Atenuable: **Si**
Dimensiones del producto: **18 mm x 49 mm**



ERIDANI III
2JCDLED30MV150

LUZ SUAVE CÁLIDA
● 3 000 K

Lumens: 160 lm
Potencia: 2 W
Volts: 100-127 V ~

Terminado: **Blanco**
IRC: **80**
Vida útil: **15 000 h**
Ángulo: **150 °**
Tipo de base: **GY6.35**
Atenuable: **No**
Dimensiones del producto: **19 mm x 47.5 mm**



IRIDIUM
G4-LED/02/30

LUZ SUAVE CÁLIDA
● 3 000 K

Lumens: 160 lm
Potencia: 2 W
Volts: 12 VDC

Terminado: **Transparente**
IRC: **80**
Vida útil: **15 000 h**
Ángulo: **300 °**
Tipo de base: **G4**
Atenuable: **No**
Dimensiones del producto: **12 mm x 41 mm x 8 mm**
Requiere Driver 12 V



IRIDIUM II
3DG9LED65V300

LUZ DE DÍA
● 6 500 K

Lumens: 280 lm
Potencia: 3 W
Volts: 100 - 127 V ~

Terminado: **Blanco**
Tipo de base: **G9**
IRC: **80**
Vida útil: **15 000 h**
Ángulo: **300 °**
Atenuable: **Si**
Dimensiones del producto: **18 mm x 53 mm**



IRIDIUM III
3DJCDLED30V300

LUZ SUAVE CÁLIDA
● 3 000 K

Lumens: 280 lm
Potencia: 3 W
Volts: 100-127 V ~

Terminado: **Blanco**
IRC: **80**
Vida útil: **15 000 h**
Ángulo: **300 °**
Tipo de base: **GY6.35**
Atenuable: **Si**
Dimensiones del producto: **18 mm x 54 mm**



IRIUM II
3DG9LED30V300

LUZ SUAVE CÁLIDA
● 3 000 K

Lumens: 280 lm
Potencia: 3 W
Volts: 100-127 V ~

Terminado: **Blanco**
IRC: **80**
Vida útil: **15 000 h**
Ángulo: **300 °**

Tipo de base: **G9**
Atenuable: **Si**
Dimensiones del producto: **18 mm x 53 mm**



**CAPELA**

10DAR111LED30DC12
LUZ SUAVE CÁLIDA
● 3 000 K

Lumens: 750 lm
Potencia: 10 W
Volts: 12 VDC

Terminado: **Cromo**
IRC: **80**
Vida útil: **25 000 h**
Ángulo: **8°**
Tipo de base: **G53**
Atenuable: **Si**
Dimensiones del producto: **111 mm x 68 mm**
Requiere Driver **12 V**

10DAR111LED30DC24
LUZ SUAVE CÁLIDA
● 3 000 K

Lumens: 800 lm
Potencia: 10 W
Volts: 12 VDC

Terminado: **Cromo**
IRC: **80**
Vida útil: **25 000 h**
Ángulo: **24°**
Tipo de base: **G53**
Atenuable: **Si**
Dimensiones del producto: **111 mm x 68 mm**
Requiere Driver **12 V**

**HELIUM I**

15DAR111LED30V12
LUZ SUAVE CÁLIDA
● 3 000 K

Lumens: 1 200 lm
Potencia: 15 W
Volts: 100-127 V ~

Terminado: **Cromo**
IRC: **80**
Vida útil: **15 000 h**
Ángulo: **8°**
Tipo de base: **G53**
Atenuable: **Si**
Dimensiones del producto: **111 mm x 68 mm**

15DAR111LED30V24
LUZ SUAVE CÁLIDA
● 3 000 K

Lumens: 1 350 lm
Potencia: 15 W
Volts: 100-127 V ~

15DAR111LED40V24
LUZ BLANCA NEUTRA
○ 4 000 K

Terminado: **Cromo**
IRC: **80**
Vida útil: **15 000 h**
Ángulo: **24°**
Tipo de base: **G53**
Atenuable: **Si**
Dimensiones del producto: **111 mm x 68 mm**

15DAR111LED65V24
LUZ DE DÍA
○ 6 500 K



ATENUABLE

G80D-LED4.5WFILBCF

LUZ SUAVE CÁLIDA
● 2 700 K

Lumens: 450 lm
Potencia: 4.5 W
Volts: 127 V ~

Terminado: **Frosted**
IRC: **80**
Vida útil: **25 000 h**
Ángulo: **360°**
Tipo de base: **E27**
Atenuable: **Si**

Dimensiones del producto: **80mm x 115mm**



ATENUABLE

MERCURI I
A19D-LEDF/001/27F

LUZ SUAVE CÁLIDA
● 2 700 K

Lumens: 450 lm
Potencia: 4.5 W
Volts: 127 V ~

Terminado: **Frosted**
IRC: **80**
Vida útil: **25 000 h**
Ángulo: **360°**
Tipo de base: **E27**
Atenuable: **Si**

Dimensiones del producto: **105 x 60 mm**



ATENUABLE

R20D-LED-4W-FILBCF

LUZ SUAVE CÁLIDA
● 2 700 K

Lumens: 300 lm
Potencia: 4.5 W
Volts: 127 V ~

Terminado: **Frosted**
IRC: **80**
Vida útil: **25 000 h**
Ángulo: **360°**
Tipo de base: **E27**
Atenuable: **Si**

Dimensiones del producto: **63mm x 85mm**



ATENUABLE

MERCURI II
A19D-LEDF/002/27

LUZ SUAVE CÁLIDA
● 2 700 K

Lumens: 700 lm
Potencia: 7 W
Volts: 127 V ~

Terminado: **Transparente**
IRC: **80**
Vida útil: **25 000 h**
Ángulo: **360°**
Tipo de base: **E27**
Atenuable: **Si**

Dimensiones del producto: **105 x 60 mm**



ATENUABLE

MERCURI
A19D-LEDF/001/27

LUZ SUAVE CÁLIDA
● 2 700 K

Lumens: 450 lm
Potencia: 4.5 W
Volts: 127 V ~

Terminado: **Transparente**
IRC: **80**
Vida útil: **25 000 h**
Ángulo: **360°**
Tipo de base: **E27**
Atenuable: **Si**

Dimensiones del producto: **105 x 60 mm**



ATENUABLE

RADON
G45D-LEDF/001/27

LUZ SUAVE CÁLIDA
● 2 700 K

Lumens: 420 lm
Potencia: 4.5 W
Volts: 127 V ~

Terminado: **Transparente**
IRC: **80**
Vida útil: **25 000 h**
Ángulo: **360°**
Tipo de base: **E27**
Atenuable: **Si**

Dimensiones del producto: **70 x 45 mm**



ATENUABLE

4DEIC12LEDF27V

LUZ SUAVE CÁLIDA
● 2 700 K

Lumens: 420 lm
Potencia: 4.5 W
Volts: 127 V ~

IRC: 80
Vida útil: **25 000 h**
Ángulo: 360 °
Tipo de base: E12
Tipo de lámpara:
LED (Integrado)
Atenuable: Si
Dimensiones del producto:
35 x 97 mm



ATENUABLE

4DEIC14LEDF27V

LUZ SUAVE CÁLIDA
● 2 700 K

Lumens: 420 lm
Potencia: 4.5 W
Volts: 127 V ~

IRC: 80
Vida útil: **25 000 h**
Ángulo: 360 °
Tipo de base: E14
Tipo de lámpara:
LED (Integrado)
Atenuable: Si
Dimensiones del producto:
35 x 97 mm



ATENUABLE

4DFFE12LEDF27V

LUZ SUAVE CÁLIDA
● 2 700 K

Lumens: 420 lm
Potencia: 4.5 W
Volts: 127 V ~

IRC: 80
Vida útil: **25 000 h**
Ángulo: 360 °
Tipo de base: E12
Tipo de lámpara:
LED (Integrado)
Atenuable: Si
Dimensiones del producto:
35 x 122 mm



ATENUABLE

4DFFE14LEDF27V

LUZ SUAVE CÁLIDA
● 2 700 K

Lumens: 420 lm
Potencia: 4.5 W
Volts: 127 V ~

IRC: 80
Vida útil: **25 000 h**
Ángulo: 360 °
Tipo de base: E14
Tipo de lámpara:
LED (Integrado)
Atenuable: Si
Dimensiones del producto:
35 x 122 mm



ATENUABLE

GALLIUM I
EIC27D-LEDF001/27

LUZ SUAVE CÁLIDA
● 2 700 K

Lumens: 420 lm
Potencia: 4.5 W
Volts: 127 V ~

Terminado: **Transparente**
IRC: 80
Vida útil: **25 000 h**
Ángulo: 360 °
Tipo de base: E27
Atenuable: Si
Dimensiones del producto:
90 x 35 mm



ATENUABLE

GALLIUM I
EIC27D-LEDF001/27F

● 2 700 K

Lumens: 420 lm
Potencia: 4.5 W
Volts: 127 V ~

Terminado: **Frosted**
IRC: 80
Vida útil: **25 000 h**
Ángulo: 360 °
Tipo de base: E27
Atenuable: Si
Dimensiones del producto:
90 x 35 mm



ATENUABLE

GALLIUM II
FFE27D-LEDF001/27

LUZ SUAVE CÁLIDA
● 2 700 K

Lumens: 420 lm
Potencia: 4.5 W
Volts: 127 V ~

Terminado: **Transparente**
IRC: 80
Vida útil: **25 000 h**
Ángulo: 360 °
Tipo de base: E27
Atenuable: Si
Dimensiones del producto:
110 x 35 mm



ATENUABLE

GALLIUM III
FFE27D-LEDF001/27F

LUZ SUAVE CÁLIDA
● 2 700 K

Lumens: 420 lm
Potencia: 4.5 W
Volts: 127 V ~

Terminado: **Frosted**
IRC: 80
Vida útil: **25 000 h**
Ángulo: 360 °
Tipo de base: E27
Atenuable: Si
Dimensiones del producto:
110 x 35 mm



S11LEDE17GLOBOBC

LUZ SUAVE CÁLIDA
● 2 700 K

Terminado: **Blanco**
IRC: **80**

Vida útil: **10 000 h**

Ángulo: **150 °**

Tipo de base: **E17**

Atenuable: **No**

Dimensiones del producto: **35 x 54mm**

Lumens: 50 lm

Potencia: 1 W

Volts: 127 V~



1S14LEDE27V27B-2

LUZ SUAVE CÁLIDA
● 2 700 K

IRC: **80**

Vida útil: **10 000 h**

Ángulo: **150 °**

Tipo de base: **E27**

Atenuable: **No**

Dimensiones del producto: **44.5 x 81.5 mm**

Lumens: 50 lm

Potencia: 1 W

Volts: 127 V~



S14LEDE27GLOBOLD

LUZ SUAVE CÁLIDA
● 2 700 K

Terminado: **Blanco**
IRC: **80**

Vida útil: **10 000 h**

Ángulo: **150 °**

Tipo de base: **E27**

Atenuable: **No**

Dimensiones del producto: **44.5 x 81.5mm**

Lumens: 50 lm

Potencia: 1 W

Volts: 127 V~



T30LEDE27TORPEDOBC

LUZ SUAVE CÁLIDA
● 2 700 K

Terminado: **Blanco**
IRC: **80**

Vida útil: **10 000 h**

Ángulo: **150 °**

Tipo de base: **E27**

Atenuable: **No**

Dimensiones del producto: **29.5 x 77.5mm**

Lumens: 50 lm

Potencia: 1 W

Volts: 127 V ~



T30LEDE27TORPEDOLD

LUZ SUAVE CÁLIDA
● 2 700 K

Terminado: **Blanco**
IRC: **80**

Vida útil: **10 000 h**

Ángulo: **150 °**

Tipo de base: **E27**

Atenuable: **No**

Dimensiones del producto: **29.5 x 77.5mm**

Lumens: 50 lm

Potencia: 1 W

Volts: 127 V ~



1T05LEDE12V27B-2

LUZ SUAVE CÁLIDA
● 2 700 K

IRC: **80**

Vida útil: **10 000 h**

Ángulo: **150 °**

Tipo de base: **E12**

Atenuable: **No**

Dimensiones del producto: **16 x 43.5 mm**

Lumens: 50 lm

Potencia: 1 W

Volts: 127 V ~



1C7LEDE12V27B-2

LUZ SUAVE CÁLIDA
● 2 700 K

IRC: **80**

Vida útil: **10 000 h**

Ángulo: **150 °**

Tipo de base: **E12**

Atenuable: **No**

Dimensiones del producto: **20.5 x 51.5 mm**

Lumens: 50 lm

Potencia: 1 W

Volts: 127 V ~



EICE12-LED/4W/30
LUZ SUAVE CÁLIDA
● 3 000 K

Lumens: 250 lm
Potencia: 4 W
Volts: 100-240 V ~

EICE12-LED/4W/65
LUZ DE DÍA
● 6 500 K

Terminado: **Blanco**
IRC: **80**
Vida útil: **15 000 h**
Ángulo: **250 °**
Tipo de base: **E12**
Atenuable: **No**
Dimensiones del producto: **38 mm x 104 mm**



EICE14-LED/4W/30
LUZ SUAVE CÁLIDA
● 3 000 K

Lumens: 250 lm
Potencia: 4 W
Volts: 100-240 V ~

EICE14-LED/4W/65
LUZ DE DÍA
● 6 500 K

Terminado: **Blanco**
IRC: **80**
Vida útil: **15 000 h**
Ángulo: **250 °**
Tipo de base: **E14**
Atenuable: **No**
Dimensiones del producto: **38 mm x 104 mm**



EICE27-LED/4W/30
LUZ SUAVE CÁLIDA
● 3 000 K
Lumens: 255 lm

Potencia: 4 W
Volts: 100-240 V ~

EICE27-LED/4W/65
LUZ DE DÍA
● 6 500 K
Lumens: 300 lm

Terminado: **Blanco**
IRC: **80**
Vida útil: **15 000 h**
Ángulo: **250 °**
Tipo de base: **E27**
Atenuable: **No**
Dimensiones del producto: **35 mm x 98 mm**



5EICE14LED30MV

LUZ SUAVE CÁLIDA
● 3 000 K

Lumens: 430 lm
Potencia: 5 W
Volts: 100-240 V ~

Terminado: **Blanco**
IRC: **80**
Vida útil: **15 000 h**
Ángulo: **240 °**
Tipo de base: **E14**
Atenuable: **No**
Dimensiones del producto: **35 mm x 98 mm**



 **ATENUABLE**
EICD-LED/6W/30
LUZ SUAVE CÁLIDA
● 3 000 K

Lumens: 470 lm
Potencia: 6 W
Volts: 100-127 V ~

EICD-LED/6W/65
LUZ DE DÍA
● 6 500 K

Terminado: **Blanco**
IRC: **80**
Vida útil: **25 000 h**
Ángulo: **240 °**
Tipo de base: **E27**
Atenuable: **Si**
Dimensiones del producto: **39 mm x 110 mm**



 **ATENUABLE**
EICMD-LED/6W/30
LUZ SUAVE CÁLIDA
● 3 000 K

Lumens: 470 lm
Potencia: 6 W
Volts: 100-127 V ~

EICMD-LED/6W/65
LUZ DE DÍA
● 6 500 K

Terminado: **Blanco**
IRC: **80**
Vida útil: **25 000 h**
Ángulo: **240 °**
Tipo de base: **E12**
Atenuable: **Si**
Dimensiones del producto: **39 mm x 109 mm**



G45E12-LED/4W/30
LUZ SUAVE CÁLIDA
● 3 000 K

Lumens: 250 lm
Potencia: 4 W
Volts: 100-240 V ~

G45E12-LED/4W/65
LUZ DE DÍA
● 6 500 K

Terminado: **Blanco**
IRC: **80**
Vida útil: **15 000 h**
Ángulo: **160 °**
Tipo de base: **E12**
Atenuable: **No**
Dimensiones del producto: **46 mm x 75 mm**



JDR-LED/6W/30
LUZ SUAVE CÁLIDA
● 3 000 K

Lumens: 550 lm
Potencia: 6 W
Volts: 100-240 V ~

Terminado: **Blanco**
IRC: **80**
Vida útil: **15 000 h**
Ángulo: **35 °**

JDR-LED/6W/65
LUZ DE DÍA
● 6 500 K

Tipo de base: **E27**
Atenuable: **No**
Dimensiones del producto: **50 mm x 58 mm**



G45E14-LED/4W/30
Potencia: 4 W
5G45E14LED30MV
Potencia: 5 W
LUZ SUAVE CÁLIDA
● 3 000 K

Lumens: 250 lm
Volts: 100-240 V ~

G45E14-LED/4W/65
Potencia: 4 W
LUZ DE DÍA
● 6 500 K

Terminado: **Blanco**
IRC: **80**
Vida útil: **15 000 h**
Ángulo: **160 °**
Tipo de base: **E14**
Atenuable: **No**
Dimensiones del producto: **45 mm x 80 mm**



G45E27-LED/4W/30
LUZ SUAVE CÁLIDA
● 3 000 K

Lumens: 250 lm
Potencia: 4 W
Volts: 100-240 V ~

G45E27-LED/4W/65
LUZ DE DÍA
● 6 500 K

Terminado: **Blanco**
IRC: **80**
Vida útil: **15 000 h**
Ángulo: **160 °**
Tipo de base: **E27**
Atenuable: **No**
Dimensiones del producto: **45 mm x 76 mm**

CEPHEI
8G95LED30MV220
LUZ SUAVE CÁLIDA
● 3 000 K

Lumens: 800 lm
Potencia: 8 W
Volts: 100-240 V ~

8G95LED65MV220
LUZ DE DÍA
● 6 500 K

Terminado: **Blanco**
IRC: **80**
Vida útil: **15 000 h**
Ángulo: **220 °**
Tipo de base: **E27**
Atenuable: **No**
Dimensiones del producto: **128 mm x 95 mm**

**NUNKI**

A19-LED/007/30
LUZ SUAVE CÁLIDA
● 3 000 K

Lumens: 450 lm
Potencia: 5 W
Volts: 100-240 V ~

A19-LED/007/65
LUZ DE DÍA
● 6 500 K

Terminado: **Blanco**
IRC: **80**
Vida útil: **15 000 h**
Ángulo: **150 °**
Tipo de base: **E27**
Atenuable: **No**
Dimensiones del producto: **55 mm x 101 mm**

**TITANIUM V**

A19-LED/005/30
LUZ SUAVE CÁLIDA
● 3 000 K

Lumens: 1 300 lm
Potencia: 14 W
Volts: 100-240 V ~

Terminado: **Blanco**
IRC: **80**
Vida útil: **15 000 h**
Ángulo: **220 °**
Tipo de base: **E27**
Atenuable: **No**
Dimensiones del producto: **60 mm x 120 mm**

**HIDRUS I**

A19-LED/010/30
LUZ SUAVE CÁLIDA
● 3 000 K

Lumens: 800 lm
Potencia: 8.5 W
Volts: 100-240 V ~

Terminado: **Blanco**
IRC: **80**
Vida útil: **15 000 h**
Ángulo: **220 °**
Tipo de base: **E27**
Atenuable: **No**
Dimensiones del producto: **55 mm x 98 mm**

**LUMIA I**

A19-LED/012/30
LUZ SUAVE CÁLIDA
● 3 000 K

Lumens: 1 000 lm
Potencia: 11 W
Volts: 100-240 V ~

A19-LED/012/65
LUZ DE DÍA
● 6 500 K

Terminado: **Blanco**
IRC: **80**
Vida útil: **15 000 h**
Ángulo: **220 °**
Tipo de base: **E27**
Atenuable: **No**
Dimensiones del producto: **60 mm x 116 mm**

**NUEVO**

17A19LED30MV270
LUZ SUAVE CÁLIDA
● 3 000 K

Lumens: 1 500 lm
Potencia: 17 W
Volts: 100-240 V ~

17A19LED65MV270
LUZ DE DÍA
● 6 500 K

Terminado: **Blanco**
IRC: **80**
Vida útil: **15 000 h**
Ángulo: **270 °**
Tipo de base: **E27**
Atenuable: **No**
Dimensiones del producto: **70 mm x 133 mm**



ATENUABLE

TITANIUM I

10DA19LED30V

LUZ SUAVE CÁLIDA
● 3 000 K

10DA19LED40V

LUZ BLANCA NEUTRA
○ 4 000 K

10DA19LED65V

LUZ DE DÍA
● 6 500 K

Lumens: **800 lm**
Potencia: **10 W**
Volts: **100-127 V ~**

Terminado: **Blanco**
IRC: **80**
Vida útil: **25 000 h**
Ángulo: **200°**
Tipo de base: **E27**
Atenuable: **Si**
Dimensiones del producto: **60 mm x 115 mm**



STEP CCT

09A19LED2740STPVB

TEMPERATURA DE COLOR AJUSTABLE
● ○ 3 000 K - 4 000 K

Lumens: **810 lm**
Potencia: **9 W**
Volts: **127 V ~**

Terminado: **Blanco**
IRC: **80**
Vida útil: **15 000 h**
Ángulo: **150°**
Tipo de base: **E27**
Tipo de lámpara: **LED (Integrado)**
Atenuable: **No**
Dimensiones del producto: **60 x 125 mm**



ATENUABLE

ZANIAH I

13DA19LED30V

LUZ SUAVE CÁLIDA
● 3 000 K

13DA19LED65V

LUZ DE DÍA
● 6 500 K

Lumens: **1 055 lm**
Potencia: **13 W**
Volts: **100-127 V ~**

Terminado: **Blanco**
IRC: **80**
Vida útil: **15 000 h**
Ángulo: **200°**
Tipo de base: **E27**
Atenuable: **Si**
Dimensiones del producto: **64 mm x 115 mm**



ATENUABLE

ZANIAH II

15DA19LED30V

LUZ SUAVE CÁLIDA
● 3 000 K

ZANIAH II

15DA19LED65V

LUZ DE DÍA
● 6 500 K

Lumens: **1 521 lm**
Potencia: **15 W**
Volts: **100-127 V ~**

Terminado: **Blanco**
IRC: **80**
Vida útil: **25 000 h**
Ángulo: **200°**

Tipo de base: **E27**
Tipo de lámpara: **LED (Integrado)**
Atenuable: **Si**
Dimensiones del producto: **68 x 138 mm**

**MAJORIS**

LEDM-001/30
LUZ SUAVE CÁLIDA
● 3 000 K

Lumens: 700 lm
Potencia: 9 W
Volts: 100-240 V ~

IRC: 80
Vida útil: **20 000 h**
Ángulo: **110 °**

LEDM-001/40
LUZ BLANCA NEUTRA
○ 4 000 K

Tipo de base: **E27**
Atenuable: **No**
Dimensiones del producto: **75 mm x 64 mm**

LEDM-001/65
LUZ DE DÍA
● 6 500 K



ALPHA
12CIRLED65MV
LUZ DE DÍA
● 6 500 K

Lumens: 1 050 lm
Potencia: 12 W
Volts: 100-240 V ~

Aplicación: **Directo al socket**
Terminado: **Blanco**
IRC: **80**
Vida útil: **15 000 h**

Ángulo: **220 °**
Tipo de base: **E27**
Dimensiones del producto: **150 mm x 82 mm**



ALPHA I
18CIRLED65MV
LUZ DE DÍA
● 6 500 K

Lumens: 1 700 lm
Potencia: 18 W
Volts: 100-240 V ~

Aplicación: **Directo al socket**
Terminado: **Blanco**
IRC: **80**
Vida útil: **15 000 h**

Ángulo: **220 °**
Tipo de base: **E27**
Dimensiones del producto: **200 mm x 80 mm**

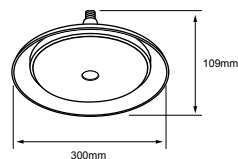
**DENEbola**

35CIRLED30MVA
LUZ SUAVE CÁLIDA
● 3 000 K

Lumens: 3 600 lm
Potencia: 35 W
Volts: 100-240 V ~

Tipo de producto: **Blanco**
IRC: **80**
Vida útil: **15 000 h**
Ángulo: **120 °**

35CIRLED65MVA
LUZ DE DÍA
● 6 500 K

Tipo de base: **E27**
Tipo de lámpara: **LED (Integrado)**
Incluye: **Driver LED**
Atenuable: **No**
Dimensiones del producto: **300 x 109 mm**



ETAMIN II
10DCIRLED30STPMV
LUZ SUAVE CÁLIDA
● 3 000 K

Lumens: 1 000 lm
Potencia: 10.5 W
Volts: 100-240 V ~

Terminado: **Blanco**
IRC: **80**
Vida útil: **15 000 h**
Ángulo: **360 °**
Tipo de base: **E27**
Atenuable: **Si**
Dimensiones del producto: **192 mm x 118 mm**
Atenuable con apagador

10DCIRLED65STPMV
LUZ DE DÍA
● 6 500 K



EFECTO FLAMA

5FLALEDE27MVB

LUZ ESTILO FLAMA

● 2 200 K

Lumens: **300 lm**
Potencia: **5 W**
Volts: **100-240 V ~**

IRC: **80**
Vida útil: **15 000 h**
Tipo de base: **E27**
Atenuable: **No**
Dimensiones del producto: **62 mm x 140 mm**
Sensor de giro, mismo efecto.



ATENUABLE

BENDLEDSR8WBC

● 2 200 K

Lumens: **300 lm**
Potencia: **8 W**
Volts: **127 V ~**

IRC: **80**
Vida útil: **10 000 h**
Tipo de base: **E27**
Atenuable: **Si**
Dimensiones del producto: **72mm x 148mm.**



ATENUABLE

BENDLEDWR8WBC

● 2 200 K

Lumens: **300 lm**
Potencia: **8 W**
Volts: **127 V ~**

IRC: **80**
Vida útil: **11 000 h**
Tipo de base: **E27**
Atenuable: **Si**
Dimensiones del producto: **88mm x 128mm.**

360° DE ILUMINACIÓN

5 AÑOS
GARANTÍA
LED



ILUMINA COMO UN FOCO DE

75W
CONSUME
7W

LUZ CÁLIDA

AHORRO MÁXIMO
90% DE LUZ
AHORRADA
VS INCANDESCENTE

NUEVO
LED 360
7A19LEDF27V360

LUZ SUAVE CÁLIDA
● 2 700 K

Lumens: 800 lm
Potencia: 7 W
Volts: 127 V~

Terminado: **Transparente**
IRC: **80**
Vida útil: **15 000 h**
Ángulo: **360°**
Tipo de base: **E27**
Atenuable: **No**
Dimensiones del producto: **60 x 105mm**



CORVUS I

6PAR20LED30MV25

LUZ SUAVE CÁLIDA

● 3 000 K

Lumens: **500 lm**

Potencia: **6 W**

Volts: **100-240 V ~**

6PAR20LED65MV25

LUZ DE DÍA

● 6 500 K

Terminado: **Blanco**

IRC: **80**

Vida útil: **25 000 h**

Ángulo: **25 °**

Tipo de base: **E27**

Atenuable: **No**

Dimensiones del producto: **63 mm x 85 mm**



ATENUABLE

CORVUS III

7DPAR20LED30V40

LUZ SUAVE CÁLIDA

● 3 000 K

Lumens: **500 lm**

Potencia: **7 W**

Volts: **100-127 V ~**

7DPAR20LED65V40

LUZ DE DÍA

● 6 500 K

Terminado: **Blanco**

IRC: **80**

Vida útil: **25 000 h**

Ángulo: **40 °**

Tipo de base: **E27**

Atenuable: **Si**

Dimensiones del producto: **63 mm x 81 mm**



Ideal para Exteriores

BOREALIS

09PAR20LED30MV35

LUZ SUAVE CÁLIDA

● 3 000 K

Lumens: **650 lm**

Potencia: **9 W**

Volts: **100-240 V ~**

Terminado: **Blanco**

IRC: **80**

Vida útil: **15 000 h**

Ángulo: **35 °**

IP: **65**

09PAR20LED65MV35

LUZ DE DÍA

● 6 500 K

Tipo de base: **E27**

Atenuable: **No**

Dimensiones del producto: **65 mm x 91.5 mm**

Ideal para exteriores



Ideal para Exteriores

BOREALIS I**13PAR30LED30MV35**

LUZ SUAVE CÁLIDA

● 3 000 K

Lumens: 900 lm
Potencia: 13 W
Volts: 100-240 V ~

Terminado: **Blanco**
 IRC: **80**
 Vida útil: **15 000 h**
 Ángulo: **35 °**
 IP: **65**

13PAR30LED65MV35

LUZ DE DÍA

● 6 500 K

Tipo de base: **E27**
 Atenuable: **No**
 Dimensiones del producto: **96 mm x 95 mm**
Ideal para exteriores

**PEGASUS I****8PAR30LED30MV25**

LUZ SUAVE CÁLIDA

● 3 000 K

Lumens: 850 lm
Potencia: 8 W
Volts: 100-240 V ~

Terminado: **Blanco**
 IRC: **80**
 Vida útil: **25 000 h**
 Ángulo: **25 °**

8PAR30LED65MV25

LUZ DE DÍA

● 6 500 K

Tipo de base: **E27**
 Atenuable: **No**
 Dimensiones del producto: **95 mm x 90 mm**



ATENUABLE

PEGASUS III**10DPAR30LED30V40**

LUZ SUAVE CÁLIDA

● 3 000 K

Lumens: 800 lm
Potencia: 10 W
Volts: 100-127 V ~

Terminado: **Blanco**
 IRC: **80**
 Vida útil: **25 000 h**
 Ángulo: **40 °**
 Tipo de base: **E27**
 Atenuable: **Si**
 Dimensiones del producto: **92 mm x 84 mm**

10DPAR30LED65V40

LUZ DE DÍA

● 6 500 K



ATENUABLE

PEGASUS IV**10DPAR30LED30V40**

LUZ SUAVE CÁLIDA

● 3 000 K

Lumens: 800 lm
Potencia: 10 W
Volts: 100-127 V ~

Terminado: **Blanco**
 IRC: **80**
 Vida útil: **25 000 h**
 Ángulo: **40 °**
 Tipo de base: **E27**
 Atenuable: **Si**
 Dimensiones del producto: **92 mm x 110 mm**



AQUILA
13PAR38LED30MV25
 LUZ SUAVE CÁLIDA
 ● 3 000 K

Lumens: **1 250 lm**
 Potencia: **13 W**
 Volts: **100-240 V ~**

13PAR38LED65MV25
 LUZ DE DÍA
 ● 6 500 K

Terminado: **Blanco**
 IRC: **80**
 Vida útil: **25 000 h**
 Ángulo: **25 °**
 Tipo de base: **E27**
 Atenuable: **No**
 Dimensiones del producto: **121 mm x 134 mm**



ORION VI
15DPAR38LED30V40
 LUZ SUAVE CÁLIDA
 ● 3 000 K

Lumens: **1 200 lm**
 Potencia: **15 W**
 Volts: **100-127 V ~**

15DPAR38LED65V40
 LUZ DE DÍA
 ● 6 500 K

Terminado: **Blanco**
 IRC: **80**
 Vida útil: **25 000 h**
 Ángulo: **40 °**
 Tipo de base: **E27**
 Atenuable: **Si**
 Dimensiones del producto: **116 mm x 128 mm**



BOREALIS II
18PAR38LED30MV35
 LUZ SUAVE CÁLIDA
 ● 3 000 K

Lumens: **1 350 lm**
 Potencia: **18 W**
 Volts: **100-240 V ~**

18PAR38LED65MV35
 LUZ DE DÍA
 ● 6 500 K

Terminado: **Blanco**
 IRC: **80**
 Vida útil: **15 000 h**
 Ángulo: **35 °**
 IP: **65**

Tipo de base: **E27**
 Atenuable: **No**
 Dimensiones del producto: **121 mm x 133 mm**
Ideal para exteriores.



ALKE
17LHBLE65MV160

LUZ DE DÍA
● 6 500 K

Lumens: 1 800 lm
Potencia: 17 W
Volts: 100-240 V ~

Terminado: **Blanco**
IRC: **80**
Vida útil: **15 000 h**
Ángulo: **160 °**
Tipo de base: **E27**
Atenuable: **No**
Dimensiones del producto: **80 mm x 151 mm**



HYPTIS II
LHBM-LED/30/65

LUZ DE DÍA
● 6 500 K

Lumens: 2 700 lm
Potencia: 30 W
Volts: 100-240 V ~

Terminado: **Blanco**
IRC: **80**
Vida útil: **25 000 h**
Ángulo: **330 °**
Tipo de base: **E27**
Atenuable: **No**
Dimensiones del producto: **228 mm x 96 mm**



HYPTIS III
LHBM-LED/50/65

LUZ DE DÍA
● 6 500 K

Lumens: 4 500 lm
Potencia: 50 W
Volts: 100-240 V ~

Terminado: **Blanco**
IRC: **80**
Vida útil: **25 000 h**
Ángulo: **330 °**
Tipo de base: **E27**
Atenuable: **No**
Dimensiones del producto: **264 mm x 108 mm**





NUEVO
LICH I
 20LHBLEDT65MV200

LUZ DE DÍA
 ● 6 500 K

Lumens: **1 800 lm**
 Potencia: **20 W**
 Volts: **100-240 V ~**

Terminado: **Blanco**
 IRC: **80**
 Vida útil: **15 000 h**
 Ángulo: **200 °**
 Tipo de base: **E27**
 Atenuable: **No**
 Dimensiones del producto: **80 x 150mm**



NUEVO
LICH II
 30LHBLEDT65MV200

LUZ DE DÍA
 ● 6 500 K

Lumens: **2 700 lm**
 Potencia: **30 W**
 Volts: **100-240 V ~**

Terminado: **Blanco**
 IRC: **80**
 Vida útil: **15 000 h**
 Ángulo: **200 °**
 Tipo de base: **E27**
 Atenuable: **No**
 Dimensiones del producto: **100 x 175mm**



NUEVO
LICH III
 40LHBLEDT65MV200

LUZ DE DÍA
 ● 6 500 K

Lumens: **3 600 lm**
 Potencia: **40 W**
 Volts: **100-240 V ~**

Terminado: **Blanco**
 IRC: **80**
 Vida útil: **15 000 h**
 Ángulo: **200 °**
 Tipo de base: **E27**
 Atenuable: **No**
 Dimensiones del producto: **118 x 200mm**



NUEVO
LICH IV
 50LHBLEDT65MV200

LUZ DE DÍA
 ● 6 500 K

Lumens: **4 500 lm**
 Potencia: **50 W**
 Volts: **100-240 V ~**

Terminado: **Blanco**
 IRC: **80**
 Vida útil: **15 000 h**
 Ángulo: **200 °**
 Tipo de base: **E27**
 Atenuable: **No**
 Dimensiones del producto: **138 x 224mm**



MEGREZ

160LHLED65MV120

LUZ DE DÍA
● 6 500 K

Lumens: **16 000 lm**
Potencia: 160W
Volts: 100-240 V ~

Terminado: Blanco
IRC: 80
Vida útil: **25 000 h**
Ángulo: 120°
Tipo de base: E40
Atenuable: No
Dimensiones del producto: 350 mm x 280 mm
Incluye adaptador E40 a E27



CAMPANA INCLUIDA

GLIESE III

100LHLED65MV120

LUZ DE DÍA
● 6 500 K

Lumens: **9 000 lm**
Potencia: 100 W
Volts: 100-240 V ~

Terminado: Blanco
IRC: 80
Vida útil: **20 000 h**
Ángulo: 120°
Tipo de base: E40
Atenuable: No
Dimensiones del producto: 210 mm x 240 mm
Incluye Campana
Incluye adaptador E40 a E27



CAMPANA INCLUIDA

BIHAM V

LHB-LED/080/65

LUZ DE DÍA
● 6 500 K

Lumens: **7 200 lm**
Potencia: 80 W
Volts: 100-240 V ~

Terminado: Blanco
IRC: 80
Vida útil: **25 000 h**
Ángulo: 120°
Tipo de base: E40
Atenuable: No



**OGMA I****09T8LED60MV65CT**LUZ DE DÍA
○ 6 500 KLumens: **800 lm**
Potencia: **9 W**
Volts: **100 - 277 V ~**Terminado: **Transparente**
IRC: **70**
Vida útil: **15 000 h**
Ángulo: **210 °**
Tipo de base: **G13**
Atenuable: **No**
Dimensiones del producto: **604 mm x 28 mm****OGMA II****18T8LED120MV40CT**LUZ BLANCA NEUTRA
○ 4 000 KLumens: **1 600 lm**
Potencia: **18 W**
Volts: **100 - 277 V ~****18T8LED120MV65CT**LUZ DE DÍA
○ 6 500 KTerminado: **Transparente**
IRC: **70**
Vida útil: **15 000 h**
Ángulo: **210 °**
Tipo de base: **G13**
Atenuable: **No**
Dimensiones del producto: **1 213 mm x 28 mm****LITHIUM V****T8CT-LED60/001/40**LUZ BLANCA NEUTRA
○ 4 000 KLumens: **800 lm**
Potencia: **9 W**
Volts: **100-127 V ~**Terminado: **Transparente**
IRC: **80**
Vida útil: **15 000 h**
Ángulo: **120 °**
Tipo de base: **G13**
Atenuable: **No**
Dimensiones del producto: **604 mm x 28 mm**



OGMA III
09T8LED60MV65C
 LUZ DE DÍA
 ● 6 500 K

Lumens: **800 lm**
 Potencia: **9 W**
 Volts: **100 - 277 V ~**

Terminado: **Frosted**
 IRC: **70**
 Vida útil: **15 000 h**

Ángulo: **210 °**
 Tipo de base: **G13**
 Atenuable: **No**
 Dimensiones del producto: **604 mm x 28 mm**

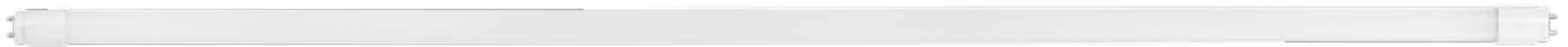

OGMA IV
18T8LED120MV40C
 LUZ BLANCA NEUTRA
 ○ 4 000 K

Lumens: **1 600 lm**
 Potencia: **18 W**
 Volts: **100 - 277 V ~**

Terminado: **Frosted**
 IRC: **70**
 Vida útil: **15 000 h**

Ángulo: **210 °**
 Tipo de base: **G13**
 Atenuable: **No**
 Dimensiones del producto: **1 213 mm x 28 mm**

18T8LED120MV65C
 LUZ DE DÍA
 ● 6 500 K



42840
 LUZ DE DÍA
 ● 6 500 K

Lumens: **1 035 lm**
 Potencia: **10 W**
 Volts: **127 - 277 V ~**

Terminado: **Blanco**
 Tipo de Lámpara: **LED (integrado)**
 IRC: **80**
 Vida útil: **40 000 h**

Ángulo: **120 °**
 Atenuable: **No**
 Dimensiones del producto: **1 213 mm x 25.4 mm**

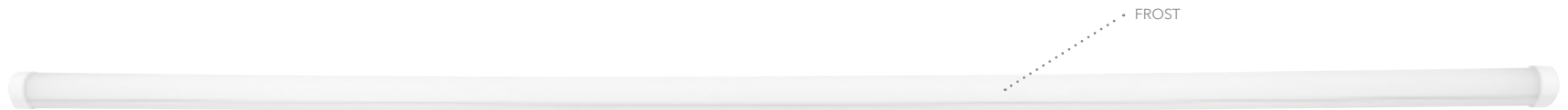
**LITHIUM VII****T8F-LED240/36/65**LUZ DE DÍA
● 6 500 KLumens: **3 600 lm**
Potencia: **36 W**
Volts: **100-240 V ~**IRC: **80**
Vida útil: **25 000 h**
Ángulo: **180 °**
Tipo de base: **FA8**
Atenuable: **No**
Dimensiones del producto: **2 367 mm x 26 mm****LITHIUM VIII****T8T-LED240/36/65**LUZ DE DÍA
● 6 500 KLumens: **3 600 lm**
Potencia: **36 W**
Volts: **100-240 V ~**IRC: **80**
Vida útil: **25 000 h**
Ángulo: **180 °**
Tipo de base: **FA8**
Atenuable: **No**
Dimensiones del producto: **2 367 mm x 26 mm**

**DABIH I**

8T5LED60V40C
LUZ BLANCA NEUTRA
○ 4 000 K

Lumens: **800 lm**
Potencia: **8 W**
Volts: **127 V ~**

8T5LED60V65C
LUZ DE DÍA
● 6 500 K

Terminado: **Blanco**
IRC: **80**
Vida útil: **15 000 h**
Ángulo: **140 °**
Tipo de base: **G5**
Atenuable: **No**
Dimensiones del producto: **549 mm x 12.7 mm**

**DABIH II**

16T5LED120V40C
LUZ BLANCA NEUTRA
○ 4 000 K

Lumens: **1 600 lm**
Potencia: **16 W**
Volts: **127 V ~**

16T5LED120V65C
LUZ DE DÍA
● 6 500 K

Terminado: **Blanco**
IRC: **80**
Vida útil: **15 000 h**
Ángulo: **140 °**
Tipo de base: **G5**
Atenuable: **No**
Dimensiones del producto: **1 149 mm x 12.7 mm**



ATENUABLE

T5D60-LED/10W/40
LUZ BLANCA NEUTRA
○ 4 000 K

Lumens: **850 lm**
Potencia: **10 W**
Volts: **100 - 127 V ~**



T5D60-LED/10W/65
LUZ DE DÍA
● 6 500 K

Terminado: **Blanco**
IRC: **80**
Vida útil: **25 000 h**
Ángulo: **100 °**
Tipo de base: **G5**
Atenuable: **Si**
Dimensiones del producto: **549 mm x 18 mm**



ATENUABLE

T5D120-LED/20W/40
LUZ SUAVE CÁLIDA
● 3 000 K

Lumens: **1 750 lm**
Potencia: **20 W**
Volts: **100 - 127 V ~**

T5D120-LED/20W/40
LUZ BLANCA NEUTRA
○ 4 000 K

T5D120-LED/20W/65
LUZ DE DÍA
● 6 500 K

Terminado: **Blanco**
IRC: **80**
Vida útil: **25 000 h**
Ángulo: **100 °**
Tipo de base: **G5**
Atenuable: **Si**
Dimensiones del producto: **1149 mm x 18 mm**



LÁMPARAS
COLOR



16PAR38LEDLLAZMV35
● 3 000 K / Azul / 6 500 K



16PAR38LEDLLVEMV35
● 3 000 K / Verde / 6 500 K



LUZ ÁMBAR

NUEVO
16PAR38LEDAMV35
● 1 800 / Luz Ámbar

Potencia: 16 W
Volts: 100-277 V ~

Terminado: Negro
IRC: 80
Vida útil: **15 000 h**
Ángulo: 35°

Tipo de base: E27
Tipo de lámpara: LED (Integrado)
Atenuable: No
Dimensiones del producto: 121 mm x 129 mm



6GU10LEDLLAZMV35
● 3 000 K / Azul / 6 500 K



6GU10LEDLLVEMV35
● 3 000 K / Verde / 6 500 K



LUZ ÁMBAR

NUEVO
6GU10LEDAMV35
● 1 800 / Luz Ámbar

Potencia: 6 W
Volts: 100-277 V ~

Terminado: Negro
IRC: 80
Vida útil: **15 000 h**

Ángulo: 35°
Tipo de base: GU10
Tipo de lámpara: LED (Integrado)
Atenuable: No
Dimensiones del producto: 50 mm x 54 mm



6MR16LEDLLAZMV35
● 3 000 K / Azul / 6 500 K



6MR16LEDLLVEMV35
● 3 000 K / Verde / 6 500 K



LUZ ÁMBAR

NUEVO
6MR16LEDAMV35
● 1 800 / Luz Ámbar

Potencia: 6 W
Volts: 100-277 V ~

Terminado: Negro
IRC: 80
Vida útil: **15 000 h**
Ángulo: 35°

Tipo de base: GX5.3
Tipo de lámpara: LED (Integrado)
Atenuable: No
Dimensiones del producto: 50 mm x 45 mm

DÉJATE CAUTIVAR POR LAS NUEVAS LÁMPARAS LUZ DE LUNA

Nuestras lámparas MOON LIGHT son la combinación perfecta de LEDs monocromáticos (blanco frío, blanco cálido y azul o verde), que como su nombre lo dice, emiten un efecto parecido a la luz de luna.

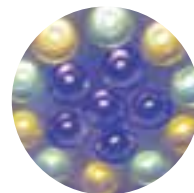

AZ

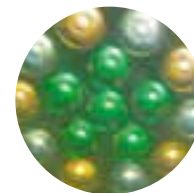

VE

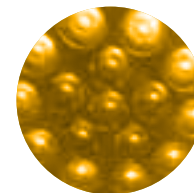

AM

TEMPERATURA DE COLOR

Crea espacios suaves y acogedores gracias a la combinación de LEDs verdes y azules con luz blanca que nos permiten crear un efecto fascinante en nuestros espacios exteriores.



IDEALES ÁRBOLES Y ARBUSTOS

El alcance de la lámpara dependerá de su ubicación, distancia del objeto y ángulo de la luminaria.

Alcance PAR: hasta 3 metros aprox.

Alcance GU10 y MR16: hasta 1 metro aprox.





MR16-SMDLED/2.3WAM

● Amarillo

Potencia: 2.3 W
Volts: 100-127 V~

Terminado: PC Transparente
Vida útil: **15 000 h**
Ángulo: 80 °
Tipo de base: GX5.3
Atenuable: No
Dimensiones del producto: 50 mm x 57 mm



MR16-SMDLED/2.3WRO

● Rojo

Potencia: 2.3 W
Volts: 100-127 V~

Terminado: PC Transparente
Vida útil: **15 000 h**
Ángulo: 80 °
Tipo de base: GX5.3
Atenuable: No
Dimensiones del producto: 50 mm x 57 mm



MR16-SMDLED/3WVE

● Verde

Potencia: 3 W
Volts: 127 V~

Terminado: PC Transparente
Vida útil: **15 000 h**
Ángulo: 80 °
Tipo de base: GX5.3
Atenuable: No
Dimensiones del producto: 50 mm x 57 mm



MR16-SMDLED/3WAZ

● Azul

Potencia: 3 W
Volts: 127 V~

Terminado: PC Transparente
Vida útil: **15 000 h**
Ángulo: 80 °
Tipo de base: GX5.3
Atenuable: No
Dimensiones del producto: 50 mm x 57 mm



MR16-SMDLED/3WRGB

● RGB

Potencia: 3 W
Volts: 100-127 V~

Terminado: PC Transparente
Vida útil: **15 000 h**
Ángulo: 80 °

Tipo de base: GX5.3
Atenuable: No
Dimensiones del producto: 50 mm x 57 mm



Cambia automáticamente
c/seg. a 7 colores diferentes.





1S14LEDE27VVE-2

● Verde

Potencia: 1 W
Volts: 127 V~

1S14LEDE27VAM-2

● Amarillo

IRC: 80
Vida útil: 10 000 h
Ángulo: 150 °

1S14LEDE27VRO-2

● Rojo

Tipo de base: E27
Atenuable: No
Dimensiones del producto: 44.5 mm x 81.5 mm

S14LEDE27GLOBOAZ

● Azul



C7LEDE12FLAMAAZ

● Azul

Potencia: 1 W
Volts: 127 V~

C7LEDE12FLAMAVE

● Verde

IRC: 80
Vida útil: 10 000 h
Ángulo: 150 °Tipo de base: E12
Atenuable: No
Dimensiones del producto: 20.5 mm x 51.5 mm

S11LEDE27GLOBOAM

● Amarillo

Potencia: 1 W
Volts: 127 V~

S11LEDE27GLOBOAZ

● Azul

IRC: 80
Vida útil: 10 000 h
Ángulo: 150 °

S11LEDE27GLOBORO

● Rojo

Tipo de base: E27
Atenuable: No
Dimensiones del producto: 35 mm x 54 mm

S11LEDE27GLOBOVE

● Verde



T30LEDE27TORPEDOAM

● Amarillo



T30LEDE27TORPEDOAZ

● Azul



T30LEDE27TORPEDORO

● Rojo



T30LEDE27TORPEDOVE

● Verde

Potencia: 1 W
Volts: 127 V~

IRC: 80
Vida útil: 10 000 h
Ángulo: 150 °

Tipo de base: E27
Atenuable: No
Dimensiones del producto: 29.5 mm x 77.5mm



2G45LEDFE27VAZ

● Azul



2G45LEDFE27VRO

● Rojo

Potencia: 2 W
Volts: 127 V~

IRC: 80
Vida útil: 25 000 h
Ángulo: 360 °

Tipo de base: E27
Atenuable: No
Dimensiones del producto: 45 mm x 75 mm



G45-LED-2W-FIL/VE

● Verde

Potencia: 2 W
Volts: 127 V~

IRC: 80
Vida útil: 25 000 h
Ángulo: 360 °
Tipo de base: E27
Atenuable: No
Dimensiones del producto: 45 mm x 75 mm



JDR-SMDLED/2.3WAM

● Amarillo

Potencia: 2.3 W
Volts: 100-127 V ~

Terminado: PC Transparente
Vida útil: 20 000 h
Ángulo: 100°
Tipo de base: E27
Atenuable: No
Dimensiones del producto: 50 mm x 51 mm



5A19LEDREPVAM-2

2 700 K

Lumens: **300 lm**
Potencia: 5 W
Volts: 127 V ~

IRC: 80
Vida útil: **25 000 h**
Ángulo: 360°

Tipo de base: **E27**
Atenuable: **No**
Dimensiones del producto: 60 mm x 105 mm



ALGOL

13PAR38LEDRMV60
● Rojo

Potencia: 13.5 W
Volts: 100-240 V ~

13PAR38LEDYMV60

● Amarillo

Terminado: **Blanco**
IRC: 80
Vida útil: **25 000 h**

13PAR38LEDGMV60

● Verde

Ángulo: 60 °
Tipo de base: **E27**
Atenuable: **No**
Dimensiones del producto: 121 mm x 134 mm

13PAR38LEDBMV60

● Azul

A collection of vintage-style light bulbs hanging from a black cord. The bulbs are illuminated, casting a warm, yellow glow. The bulbs vary in shape and size, including large round ones and smaller, more industrial-looking ones. The background is a soft, out-of-focus light color.

LÁMPARAS
VINTAGE



ATENUABLE

NUEVO**3DAXLEDFC20VA**

LUZ SUAVE CÁLIDA
● 2 000 K

Lumens: 120 lm
Potencia: 3.5 W
Volts: 127 V ~

Terminado: **Ambar**
IRC: **80**
Vida útil: **15 000 h**
Ángulo: **36 °**
Tipo de base: **E27**
Atenuable: **Sí**
Dimensiones del producto: **110 mm x 158 mm**



ATENUABLE

NUEVO**3DG125KEDFC20VAS**

LUZ SUAVE CÁLIDA
● 2 000 K

Lumens: 120 lm
Potencia: 3.5 W
Volts: 127 V ~

Terminado: **Ambar**
IRC: **80**
Vida útil: **15 000 h**
Ángulo: **46 °**
Tipo de base: **E27**
Atenuable: **Sí**
Dimensiones del producto: **125 mm x 164 mm**



ATENUABLE

NUEVO**3DG200LEDFC20VAH**

LUZ SUAVE CÁLIDA
● 2 000 K

Lumens: 120 lm
Potencia: 3.5 W
Volts: 127 V ~

Terminado: **Ambar**
IRC: **80**
Vida útil: **15 000 h**
Ángulo: **60 °**
Tipo de base: **E27**
Atenuable: **Sí**
Dimensiones del producto: **200 mm x 241mm**



ATENUABLE

NUEVO**3DS123LEDFC20VA**

LUZ SUAVE CÁLIDA
● 2 000 K

Lumens: 120 lm
Potencia: 3.5 W
Volts: 127 V ~

Terminado: **Ambar**
IRC: **80**
Vida útil: **15 000 h**
Ángulo: **55 °**
Tipo de base: **E27**
Atenuable: **Sí**
Dimensiones del producto: **125 mm x 161mm**



ATENUABLE

NUEVO

3DTS94LEDFC20VA

LUZ SUAVE CÁLIDA
● 2 000 K

Lumens: 120 lm
Potencia: 3.5 W
Volts: 127 V ~

Terminado: **Ambar**
IRC: **80**
Vida útil: **15 000 h**
Ángulo: **18 °**
Tipo de base: **E27**
Atenuable: **Sí**
Dimensiones del producto: **92 mm x 305 mm**



ATENUABLE

NUEVO

3DS125LEDFC20VA

LUZ SUAVE CÁLIDA
● 2 000 K

Lumens: 120 lm
Potencia: 3.5 W
Volts: 127 V ~

Terminado: **Ambar**
IRC: **80**
Vida útil: **15 000 h**
Ángulo: **55 °**
Tipo de base: **E27**
Atenuable: **Sí**
Dimensiones del producto: **127 mm x 223 mm**



ATENUABLE

NUEVO

4DG125LEDFC20V3D

LUZ SUAVE CÁLIDA
● 2 700 K

Lumens: 100 lm
Potencia: 4 W
Volts: 127 V ~

Terminado: **Ambar**
IRC: **80**
Vida útil: **15 000 h**
Ángulo: **340 °**
Tipo de base: **E27**
Atenuable: **Sí**
Dimensiones del producto: **125 mm x 172 mm**



ATENUABLE

AHIL

3DG125LEDFC20VA Ambar



3DG125LEDFC20VAR Ambar Rombos



3DG125LEDFC20VAL Ambar Lineas

LUZ SUAVE CÁLIDA
● 2 000 KLumens: **120 lm**
Potencia: 3.5 W
Volts: 127 V ~IRC: 80
Vida útil: **15 000 h**
Ángulo: 300 °Tipo de base: E27
Atenuable: Si
Dimensiones del producto: 125 mm x 164 mm

ATENUABLE

AIN

3DG200LEDFC20VA

Lumens: **120 lm**

3DG200LEDFC20VH Humo

Lumens: **70 lm**LUZ SUAVE CÁLIDA
● 2 000 KPotencia: 3.5 W
Volts: 127 V ~Terminado: Ambar
IRC: 80
Vida útil: **15 000 h**
Ángulo: 300 °Tipo de base: E27
Atenuable: Si
Dimensiones del producto: 200 mm x 241 mm

ATENUABLE

DIAMOND

3DD125LEDFC20VA



ATENUABLE

BOX

3DS170LEDFC20VA

LUZ SUAVE
CÁLIDA
● 2 000 K
Lumens: **120 lm**
Potencia: 3.5 W
Volts: 127 V ~Terminado: Ambar
IRC: 80
Vida útil: **15 000 h**
Ángulo: 300 °Tipo de base: E27
Atenuable: Si
Dimensiones del producto: 125 mm x 142 mmLUZ SUAVE
CÁLIDA
● 2 000 K
Lumens: **120 lm**
Potencia: 3.5 W
Volts: 127 V ~Terminado: Ambar
IRC: 80
Vida útil: **15 000 h**
Ángulo: 300 °Tipo de base: E27
Atenuable: Si
Dimensiones del producto: 170 mm x 197 mm



7G90LEDF27VH

LUZ SUAVE CÁLIDA
● 2 700 K

Lumens: 790 lm
Potencia: 7 W
Volts: 127 V ~

Terminado: **Ambar**
IRC: **80**
Vida útil: **25 000 h**
Ángulo: **360 °**
Tipo de base: **E27**
Atenuable: **No**
Dimensiones del producto: **125 mm x 170 mm**



ATENUABLE

4DG80LEDF27VT

LUZ SUAVE CÁLIDA
● 2 700 K

Lumens: 450 lm
Potencia: 4.5 W
Volts: 127 V ~

Terminado: **Cristal transparente**
IRC: **80**
Vida útil: **25 000 h**
Ángulo: **360 °**
Tipo de base: **E27**
Atenuable: **Sí**
Dimensiones del producto: **80 mm x 115 mm**



2G125LEDE27V20CT

LUZ SUAVE CÁLIDA
● 2 200 K

Lumens: 200 lm
Potencia: 2 W
Volts: 127 V ~

Terminado: **Cristal transparente**
IRC: **80**
Vida útil: **15 000 h**
Ángulo: **360 °**
Tipo de base: **E27**
Atenuable: **No**
Dimensiones del producto: **125 mm x 168 mm**



ATENUABLE

4DG125LEDF27VT

LUZ SUAVE CÁLIDA
● 2 700 K

Lumens: 450 lm
Potencia: 4.5 W
Volts: 127 V ~

Terminado: **Cristal transparente**
IRC: **80**
Vida útil: **25 000 h**
Ángulo: **360 °**
Tipo de base: **E27**
Atenuable: **Sí**
Dimensiones del producto: **125 mm x 170 mm**



ATENUABLE

**4DC35LEDFTE12V27A**

LUZ SUAVE CÁLIDA
● 2 700 K

Lumens: 420 lm
Potencia: 3.8 W
Volts: 127 V ~

Terminado: **Ambar**
IRC: **80**
Vida útil: **25 000 h**
Ángulo: **360 °**
Tipo de base: **E12**
Atenuable: **Si**

Dimensiones del producto: **35 mm x 105 mm**



ATENUABLE

**4DC35LEDFTE27V27A**

LUZ SUAVE CÁLIDA
● 2 700 K

Lumens: 420 lm
Potencia: 3.8 W
Volts: 127 V ~

Terminado: **Ambar**
IRC: **80**
Vida útil: **25 000 h**
Ángulo: **360 °**
Tipo de base: **E27**
Atenuable: **Si**

Dimensiones del producto: **35 mm x 105 mm**



ATENUABLE

**4DT10LEDF27VT**

LUZ SUAVE CÁLIDA
● 2 700 K

Lumens: 450 lm
Potencia: 4.5 W
Volts: 127 V ~

Terminado: **Cristal transparente**
IRC: **80**
Vida útil: **25 000 h**
Ángulo: **360 °**
Tipo de base: **E27**
Atenuable: **Si**

Dimensiones del producto: **30 mm x 123 mm**

**VLED-T30-2W-E27**

● 2 200 K

Lumens: 200 lm
Potencia: 2 W
Volts: 127 V ~

Terminado: **Transparente**
IRC: **80**
Vida útil: **15 000 h**
Ángulo: **360 °**
Atenuable: **No**

Dimensiones del producto: **30 mm x 185 mm**



ATENUABLE

**ALBIREO I**
2DT30LEDFC20VA

LUZ SUAVE CÁLIDA
● 2 000 K

Lumens: 60 lm
Potencia: 2.3 W
Volts: 127 V ~

Terminado: **Ambar**
IRC: **80**
Vida útil: **15 000 h**
Ángulo: **300 °**
Tipo de base: **E27**
Atenuable: **Si**

Dimensiones del producto: **30 mm x 185 mm**



ATENUABLE

**ALBIREO II**
3DT60LEDFC20VA

LUZ SUAVE CÁLIDA
● 2 000 K

Lumens: 120 lm
Potencia: 3.5 W
Volts: 127 V ~

Terminado: **Ambar**
IRC: **80**
Vida útil: **15 000 h**
Ángulo: **300 °**
Tipo de base: **E27**
Atenuable: **Si**

Dimensiones del producto: **60 mm x 300 mm**



ATENUABLE

4DST21LEDFT27VA

LUZ SUAVE CÁLIDA
● 2 700 K

Lumens: 450 lm
Potencia: 4.5 W
Volts: 127 V ~

Terminado: **Ambar**
IRC: **80**
Vida útil: **25 000 h**
Ángulo: **360 °**
Tipo de base: **E27**
Atenuable: **Si**
Dimensiones del producto: **64 mm x 138 mm**



ATENUABLE

4DST64LEDFC27VH

LUZ SUAVE CÁLIDA
● 2 700 K

Lumens: 450 lm
Potencia: 4.5 W
Volts: 127 V ~

Terminado: **Humo**
IRC: **80**
Vida útil: **25 000 h**
Ángulo: **360 °**
Tipo de base: **E27**
Atenuable: **Si**
Dimensiones del producto: **64 mm x 138 mm**

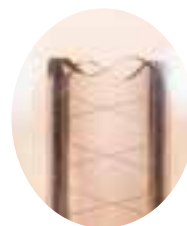
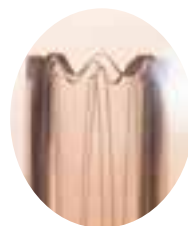
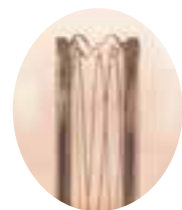

ATENUABLE

ADHAFERA

2DA19LEDFC20VA 2DA19LEDFT20VA

LUZ SUAVE CÁLIDA
● 2 000 K

Lumens: 60 lm
Potencia: 2.3 W
Volts: 127 V ~

Terminado: **Ambar**
IRC: **80**
Vida útil: **15 000 h**
Ángulo: **300 °**
Tipo de base: **E27**
Atenuable: **Si**
Dimensiones del producto: **60 mm x 112 mm**



ATENUABLE

VULPECULA

3DST64LEDFC20VA 3DST64LEDFT20VA

LUZ SUAVE CÁLIDA
● 2 000 K

Lumens: 120 lm
Potencia: 3.5 W
Volts: 127 V ~

Terminado: **Ambar**
IRC: **80**
Vida útil: **15 000 h**
Ángulo: **300 °**
Tipo de base: **E27**
Atenuable: **Si**
Dimensiones del producto: **64 mm x 142 mm**



ATENUABLE

SCUTUM

3DB75LEDFC20VA

LUZ SUAVE CÁLIDA
● 2 000 K

Lumens: 120 lm
Potencia: 3.5 W
Volts: 127 V ~

Terminado: **Ambar**
IRC: **80**
Vida útil: **15 000 h**
Ángulo: **300 °**
Tipo de base: **E27**
Atenuable: **Si**
Dimensiones del producto: **75 mm x 162 mm**



AM



H



AM



H



ATENUABLE

ACUBENS**3DBT160LEDFC20VA**

Ámbar

Lumens: **120 lm****3DBT160LEDFC20VH**

Humo

Lumens: **70 lm**LUZ SUAVE CÁLIDA
● 2 000 KPotencia: **3.5 W**
Volts: **127 V ~**IRC: **80**
Vida útil: **15 000 h**
Ángulo: **300 °**
Tipo de base: **E27**
Atenuable: **Si**
Dimensiones del producto: **160 mm x 331 mm**

ATENUABLE

ACRAB**3DA165LEDFC20VA**

Ámbar

Lumens: **120 lm****3DA165LEDFC20VH**

Humo

Lumens: **70 lm**LUZ SUAVE CÁLIDA
● 2 000 KPotencia: **3.5 W**
Volts: **127 V ~**IRC: **80**
Vida útil: **15 000 h**
Ángulo: **300 °**
Tipo de base: **E27**
Atenuable: **Si**
Dimensiones del producto: **165 mm x 303 mm**



ATENUABLE

35DST45INFCE27VH

LUZ SUAVE CÁLIDA
● 2 000 K

Lumens: 120 lm
Potencia: 35 W
Volts: 127 V ~

Terminado: **Humo**
IRC: **99**
Vida útil: **3 000 h**
Ángulo: **360 °**
Tipo de base: E27
Atenuable: Si
Dimensiones del producto: **45 mm x 90 mm**



ATENUABLE

35DST64INFCE27VH

LUZ SUAVE CÁLIDA
● 2 000 K

Lumens: 130 lm
Potencia: 35 W
Volts: 127 V ~

Terminado: **Humo**
IRC: **99**
Vida útil: **3 000 h**
Ángulo: **360 °**
Tipo de base: E27
Atenuable: Si
Dimensiones del producto: **64 mm x 135 mm**



ATENUABLE

35DT45INFCE27VH

LUZ SUAVE CÁLIDA
● 2 000 K

Lumens: 120 lm
Potencia: 35 W
Volts: 127 V ~

Terminado: **Humo**
IRC: **99**
Vida útil: **3 000 h**
Ángulo: **360 °**
Tipo de base: E27
Atenuable: Si
Dimensiones del producto: **45 mm x 102 mm**



ATENUABLE

4DST160LEDF20VA

LUZ SUAVE CÁLIDA
● 2 200 K

Lumens: 350 lm
Potencia: 4 W
Volts: 127 V ~

Terminado: **Ambar**
IRC: **80**
Vida útil: **25 000 h**
Ángulo: **360 °**
Tipo de base: E27
Atenuable: Si
Dimensiones del producto: **160 mm x 285 mm**



ATENUABLE

25DC35INFTE12VH

LUZ SUAVE CÁLIDA
● 2 000 K

Lumens: 60 lm
Potencia: 25 W
Volts: 127 V ~

Terminado: **Humo**
IRC: **99**
Vida útil: **3 000 h**
Ángulo: **360 °**
Tipo de base: E12
Atenuable: Si
Dimensiones del producto: **35 mm x 110 mm**



ATENUABLE

25DC35INFTE27VH

LUZ SUAVE CÁLIDA
● 2 000 K

Lumens: 60 lm
Potencia: 25 W
Volts: 127 V ~

Terminado: **Humo**
IRC: **99**
Vida útil: **3 000 h**
Ángulo: **360 °**
Tipo de base: E27
Atenuable: Si
Dimensiones del producto: **35 mm x 110 mm**



ATENUABLE

35DG125INFCE27VH

LUZ SUAVE CÁLIDA
● 2 000 K

Lumens: 70 lm
Potencia: 35 W
Volts: 127V ~

Terminado: **Humo**
IRC: **99**
Vida útil: **3 000 h**
Ángulo: **360 °**
Tipo de base: **E27**
Atenuable: **Si**
Dimensiones del producto: **125 mm x 168 mm**



ATENUABLE

35DG80INFTE27VH

LUZ SUAVE CÁLIDA
● 2 000 K

Lumens: 110 lm
Potencia: 35 W
Volts: 127V ~

Terminado: **Humo**
IRC: **99**
Vida útil: **3 000 h**
Ángulo: **360 °**
Tipo de base: **E27**
Atenuable: **Si**
Dimensiones del producto: **80 mm x 115 mm**



ATENUABLE

35DT2817INFTE27VH

LUZ SUAVE CÁLIDA
● 2 000 K

Lumens: 120 lm
Potencia: 35 W
Volts: 127 V ~

Terminado: **Humo**
IRC: **99**
Vida útil: **3 000 h**
Ángulo: **360 °**
Tipo de base: **E27**
Atenuable: **Si**
Dimensiones del producto: **30 mm x 185 mm**



ATENUABLE

35DT2821INFCE27VH

LUZ SUAVE CÁLIDA
● 2 000 K

Lumens: 115 lm
Potencia: 35 W
Volts: 127 V ~

Terminado: **Humo**
IRC: **99**
Vida útil: **3 000 h**
Ángulo: **360 °**
Tipo de base: **E27**
Atenuable: **Si**
Dimensiones del producto: **30 mm x 215 mm**



ATENUABLE

35DT2830INFTE27VH

LUZ SUAVE CÁLIDA
● 2 000 K

Lumens: 130 lm
Potencia: 35 W
Volts: 127 V ~

Terminado: **Humo**
IRC: **99**
Vida útil: **3 000 h**
Ángulo: **360 °**
Tipo de base: **E27**
Atenuable: **Si**
Dimensiones del producto: **30 mm x 300 mm**

A photograph of several vintage-style light bulbs hanging from black cords. Some bulbs are glowing with a warm, yellow light, while others are unlit. The background features green foliage and a window with blinds, creating a soft, bokeh effect. A horizontal orange and red gradient bar is overlaid across the middle of the image.

SOCKETS

VINTAGE

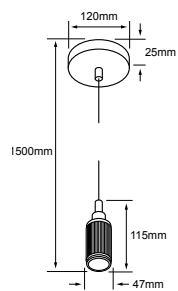

NUEVO

60SOCK110MVE27HA
Hierro Antiguo

Potencia máx: 60 W
Volts: 100-240 V ~

Socket con canope, Base E27

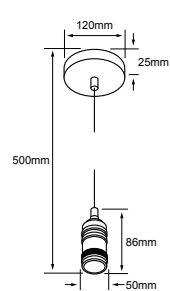

NUEVO

60SOCK111MVE27HA
Hierro Antiguo

Potencia máx: 60 W
Volts: 100-240 V ~

Socket con canope, Base E27

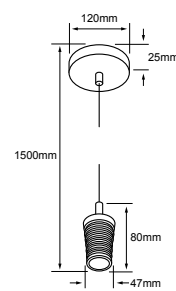

NUEVO

60SOCK112MVE27O
Oro

Potencia máx: 60 W
Volts: 100-240 V ~

Socket con canope, Base E27

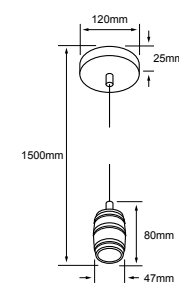

NUEVO

60SOCK113MVE27S
Satin

Potencia máx: 60 W
Volts: 100-240 V ~

Socket con canope, Base E27

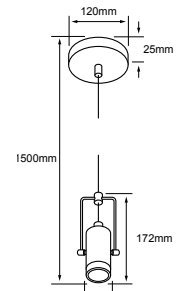

NUEVO

60SOCK114MVE27N
Negro / Bronce

Potencia máx: 60 W
Volts: 100-240 V ~

Socket con canope, Base E27

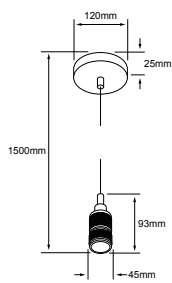

NUEVO

60SOCK115MVE27S
Satin

Potencia máx: 60 W
Volts: 100-240 V ~

Socket con canope, Base E27

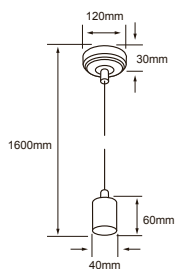

60SOCK044MVE27N
Negro

Potencia máx: 60 W
Volts: 100-240 V ~
Atenuable: No
Dimensiones del producto:
38 mm x 870 mm
Socket con canope, Base E27

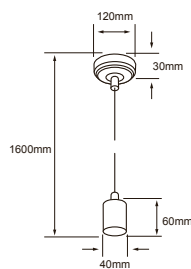

60SOCK055MVE27HA
Hierro antiguo

Volts: 100-240 V ~
Potencia máx: 60 W
Atenuable: No
Dimensiones del producto:
40 mm x 770 mm
Socket con canope, Base E27

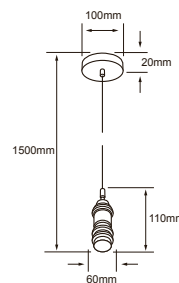

SOCKVIN104
Hierro antiguo

Potencia máx: 60 W
Volts: 100-240 V ~
Atenuable: No
Dimensiones del producto:
38 mm x 870 mm
Socket con canope, Base E27

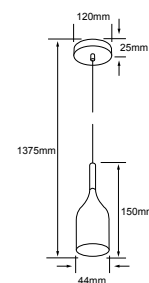

60SOCK106MVE27N
Negro

Volts: 100-240 V ~
Potencia máx: 60 W
Atenuable: No
Dimensiones del producto:
45 mm x 1500 mm
Socket con canope, Base E27



FLUORESCENTES



HEL-65W/65

HEL-100W/65

HEL-20W/BLB

PRODUCTO	LUMENS	POTENCIA	VOLTS	TEMPERATURA DE COLOR	IRC	TIEMPO DE VIDA	TIPO DE BASE	DIMENSIONES DEL PRODUCTO (BXA) +/-5 MM	OBSERVACIONES
HEL-20W/BLB	-	20 W	100-127 V ~	6500 K	-	6 000 h	E27	61 mm x 132 mm	Ahorrador
HEL-65W/65	4 400 lm	65 W	100-127 V ~	6500 K	80	10 000 h	E27	83 mm x 235 mm	Ahorrador
HEL-100W/65	6 000 lm	100 W	100-127 V ~	6500 K	80	10 000 h	E27	112 mm x 300 mm	Ahorrador
HEL-100W/65-220	6 000 lm	100 W	220 V ~	6500 K	80	10 000 h	E40	105 mm x 306 mm	Ahorrador



13W



15W



20W



23W



26W

PRODUCTO	LUMENS	POTENCIA	VOLTS	TEMPERATURA DE COLOR	IRC	TIEMPO DE VIDA	TIPO DE BASE	DIMENSIONES DEL PRODUCTO (BXA) +/-5 MM	OBSERVACIONES
HEL-13W/27-T2	800 lm	13 W	100-127 V ~	2700 K	80	10 000 h	E27	49.5 mm x 101.5mm	Ahorrador
HEL-13W/65-T2	800 lm	13 W	100-127 V ~	6500 K	80	10 000 h	E27	49.5 mm x 101.5mm	Ahorrador
HEL-15W/65-T2	1 100 lm	15 W	100-127 V ~	6500 K	80	10 000 h	E27	46 mm x 104 mm	Ahorrador
HEL-20W/65-T2	1 300 lm	20 W	100-127 V ~	6500 K	80	10 000 h	E27	55 mm x 110 mm	Ahorrador
HEL-23W/65-T2	1 600 lm	23 W	100-127 V ~	6500 K	80	10 000 h	E27	60 mm x 112 mm	Ahorrador
HEL-26W/65-T2	1 850 lm	26 W	100-127 V ~	6500 K	80	10 000 h	E27	60 mm x 119.5 mm	Ahorrador



PRODUCTO	LUMENS	POTENCIA	VOLTS	TEMPERATURA DE COLOR	IRC	TIEMPO DE VIDA	TIPO DE BASE	DIMENSIONES DEL PRODUCTO (BXA) +/-5 MM
42755	1 150 lm	14 W	120-277 V ~	4100K	80	25 000 h	G5	563 mm x 16 mm
42756	1 100 lm	14 W	120-277 V ~	6500 K	80	25 000 h	G5	563 mm x 16 mm
42757	2 450 lm	28 W	120-277 V ~	4100K	80	25 000 h	G5	1 163 mm x 16 mm
42758	2 350 lm	28 W	120-277 V ~	6500 K	80	25 000 h	G5	1 163 mm x 16 mm
42759	4 400 lm	49 W	120-277 V ~	4100K	80	25 000 h	G5	1 163 mm x 16 mm

PRODUCTO	LUMENS	POTENCIA	VOLTS	TEMPERATURA DE COLOR	IRC	TIEMPO DE VIDA	TIPO DE BASE	DIMENSIONES DEL PRODUCTO (BXA) +/-5 MM
F4T5BL	-	4 W	127 V ~	Luz negra con filtro	-	8 000 h	G5	150 mm x 16 mm
F6T5D	250 lm	6 W	127 V ~	Luz de día	80	8 000 h	G5	226 mm x 16 mm

TRANSFORMADOR



TRA-50

PRODUCTO	LUMENS	POTENCIA	VOLTS	TIEMPO DE VIDA	ÁNGULO	TIPO DE BASE	DIMENSIONES DEL PRODUCTO (BXA) +/-5 MM
TRA-50	-	60 W	127 V / 12 V ~	-	-	-	54 mm x 26 mm

TABLA DE CLASIFICACIÓN IP

Grado de protección IP se representa mediante la combinación de los dígitos de la primera y la segunda columna, véase el ejemplo.

1er DIGITO: Objetos

Grado de protección de objetos sólidos

	Sin protección.	0
	Protección contra objetos sólidos de más de 50 mm. (Contacto involuntario de las manos)	1
	Protección contra objetos sólidos de más de 12 mm. (Contacto con los dedos)	2
	Protección contra objetos sólidos de más de 2.5 mm. (Herramientas y cables)	3
	Protección contra objetos sólidos de más de 1 mm. (Herramientas y pequeños cables)	4
	Protección contra ingreso limitado de polvo. (No incluye materiales peligrosos)	5
	Totalmente protegido contra polvo. Totalmente sellado.	6

2º DIGITO: Líquidos

Grado de protección resistente al agua

	Sin protección.	0
	Protección contra caídas verticales de gotas de agua o condensación.	1
	Protección contra caídas verticales de gotas con una inclinación de 15° respecto a la vertical.	2
	Protección contra caídas verticales de gotas con una inclinación de 60° respecto a la vertical.	3
	Protección contra salpicaduras de gotas en todas direcciones, el ingreso de cantidades limitadas de agua es permitido.	4
	Protegido contra chorros de agua a baja presión, el ingreso limitado de agua es permitido.	5
	Protegido contra potentes chorros de agua.	6
	Protegido contra efectos de inmersión temporal.	7
	Equipo adecuado para inmersión prolongada bajo las especificaciones de fabricante.	8

IP **6** **5**

Totalmente protegido contra polvo. Totalmente sellado.



+



Protegido contra chorros de agua a baja presión, el ingreso limitado de agua es permitido.

ZONA 2 IP44/45 : Luminarios en muro

Se requiere que se encuentren en lugares techados.

ZONA 5 IP68 : Luminarios de piscinas/estanques

La máxima protección posible y diseñadas para su instalación sumergidas.

ZONA 4 IP67 : Luminarios al borde de piscinas o estanques

Luminarias protegidas al máximo contra la acción del polvo y preparadas para inmersiones de agua temporales.

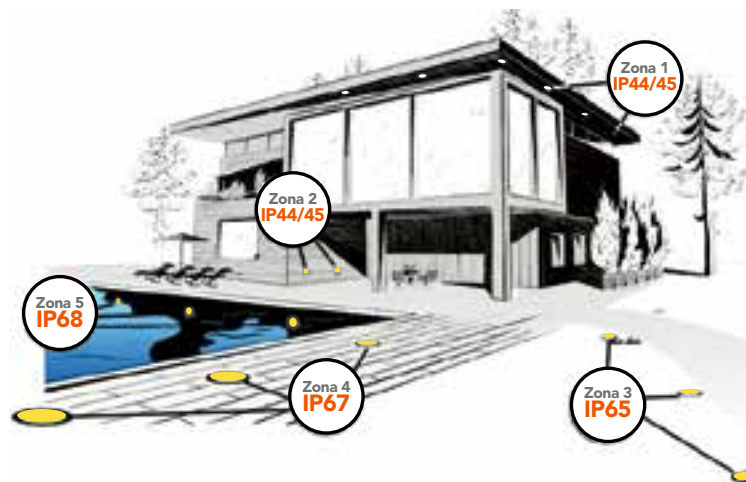

ZONA 1 IP44/45 : Luminarios bajo techo

Se requiere que estén en lugares techados, ejemplo: una marquesina. Están protegidos contra salpicaduras de gotas.

ZONA 3 IP65 : Luminarios empotrados en jardín

Este tipo de luminarias cuentan con la máxima protección contra la acción del polvo y agua.

tecnolite[®]
LA LUZ ES TUYA

tecnolite.mx

